

1



2



3

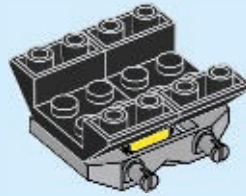

4

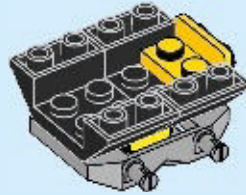

5

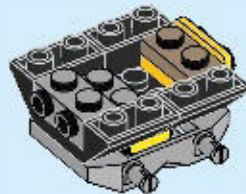

6

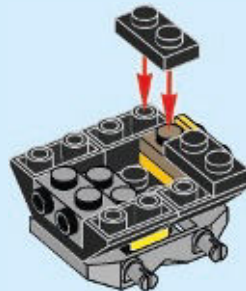

7



8

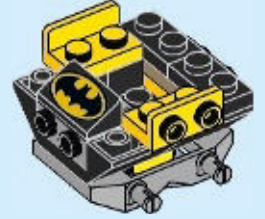

9

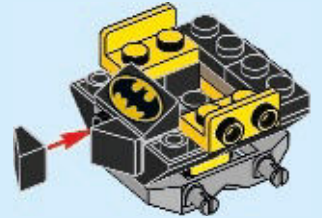

10



11

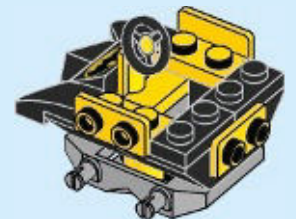

12

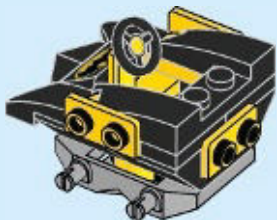

13

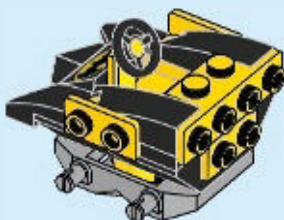

14

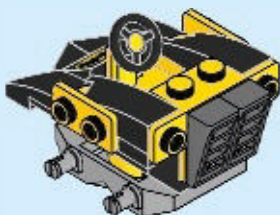

15

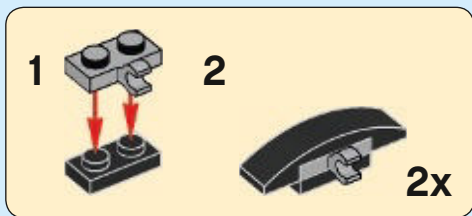
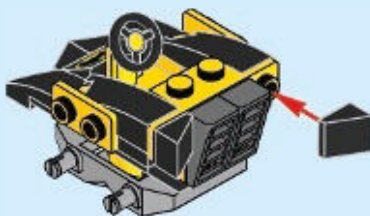

16

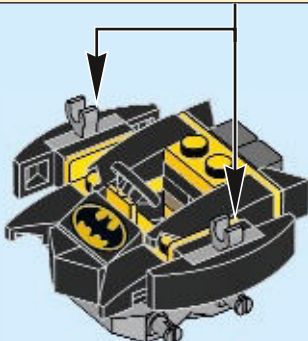

17

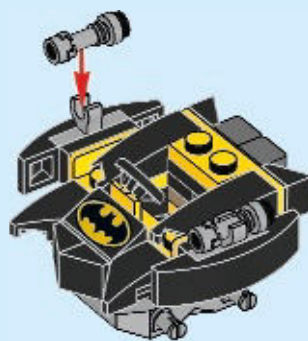

18

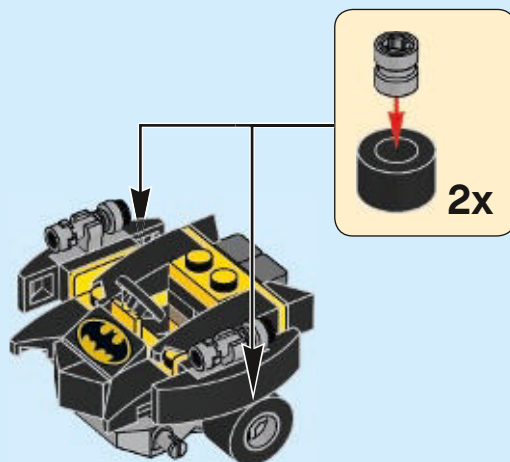

19

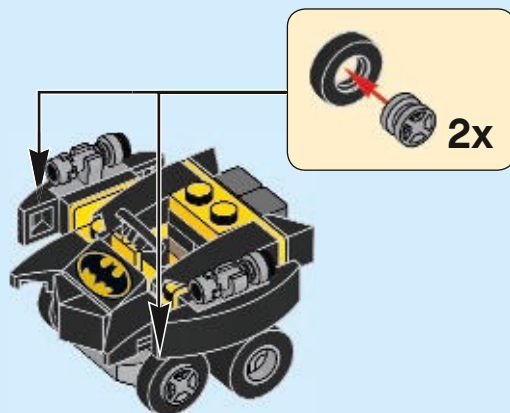

LEGO.com/service

LEGO and the LEGO logo are trademarks of the LEGO Group. ©2018 The LEGO Group. 6222187

All DC characters and elements © & ™ DC Comics.

WB SHIELD: TM & © WBEI. (s18)