



DC COMICS  
**SUPERHEROES**



76035



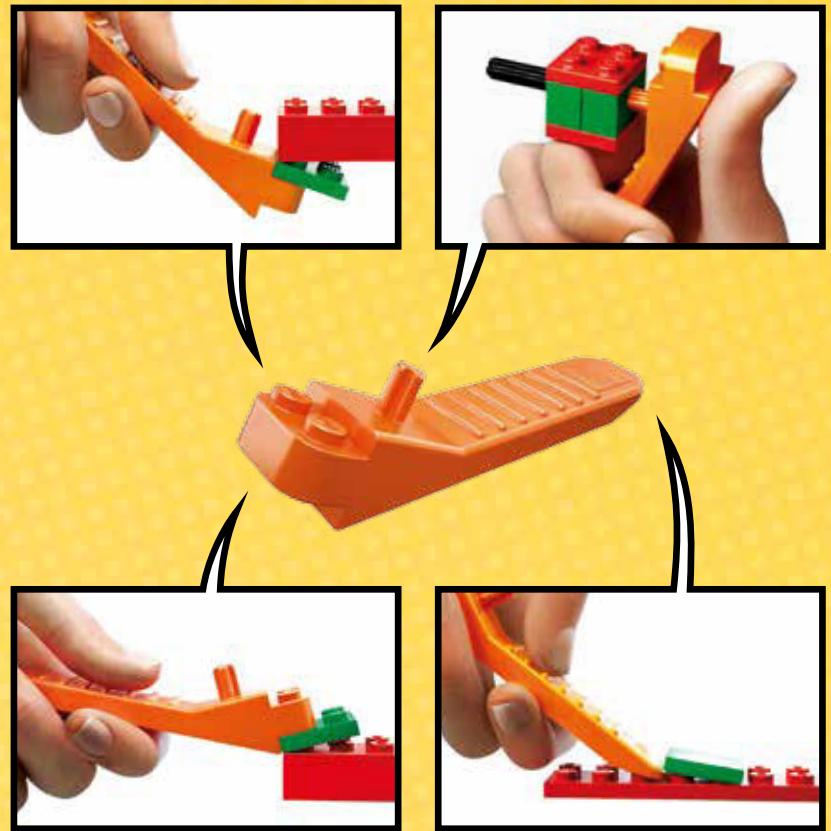

[LEGO.com/brickseparator](https://LEGO.com/brickseparator)

EN IMPORTANT: Never modify the elements or use other projectiles than provided with this toy.  
 DE WICHTIG: Die Elemente dürfen nicht verändert werden. Es dürfen ausschließlich die mit dem Spielzeug mitgelieferten Geschosse verwendet werden.  
 FR IMPORTANT : Ne jamais modifier les éléments ni utiliser d'autres projectiles que ceux fournis avec ce jouet.  
 IT IMPORTANTE: non modificare gli elementi o utilizzare proiettili non forniti con questo prodotto.  
 NL BELANGRIJK! Verander niets aan de elementen en gebruik geen andere projectielen dan de bij het speelgoed geleverde.  
 ES IMPORTANTE: No modifique los elementos ni utilice otros proyectiles diferentes a los suministrados junto con este juguete.  
 DA VIGTIGT: Elementerne må ikke ændres, og der må ikke bruges andre projektiler end dem, der følger med legetøjet.  
 FI TÄRKEÄÄ: Älä koskaan tee osiin muutoksia tai käytä lelussa muita kuin sen sisälttämiä ammuksia.  
 SV VIKTIGT: Modifiera aldrig delarna och använd aldrig andra projektiler än de som medföljer denna leksak.  
 PT IMPORTANTE: Nunca modifique os elementos nem utilize projécteis que não tenham sido fornecidos com este brinquedo.  
 EL ΣΗΜΑΝΤΙΚΟ: Ποτέ μην τροποποιείτε τα στοιχεία του παιχνιδιού και μην χρησιμοποιείτε άλλα βλήματα εκτός από αυτά που συνοδεύουν αυτό το παιχνίδι.  
 JA 重要：部品を改造したり、本製品に付属の発射体以外のものを使用しないでください。  
 ZH 重要提示：切勿更改组件或使用并非由本玩具附带的弹丸。  
 KO 중요함: 이들 부품을 수정하거나 이 완구와 함께 제공된 것이 아닌 발사체는 결코 사용하지 마십시오.  
 RU ВАЖНО: запрещается вносить изменения в элементы или использовать другие снаряды, отличные от тех, которые поставляются с данной игрушкой.  
 PL WAŻNE: Nigdy nie modyfikować elementów zabawki ani nie używać pocisków innych niż dostarczone z zabawką.  
 CZ UPOZORNĚNÍ: Nikdy neupravujte součástky a nepoužívejte jiné projektily než ty, které jsou dodávány s touto hračkou.  
 SK UPOZORNENIE: Nikdy neupravujte súčiastky a nepoužívajte iné projektily než tie, ktoré sú dodávané s touto hračkou.  
 HU FONTOS: Az elemeket nem szabad módosítani, és a játékhöz adott lövedékek helyett sem szabad mást használni.  
 UA ВАЖЛИВО: забороняється вносити зміни до елементів або використовувати інші снаряди на відміну від тих, що поставляються з цією іграшкою.  
 HR VAŽNO: Nemojte nikad mijenjati elemente ili koristiti druge projekte osim onih koji su bili priloženi uz ovu igračku prilikom kupnje.  
 SR Важно: Nemojte da modifikujete elemente i ne koristite druge projekte osim onih koji dolaze uz ovu igračku.  
 SL POMEMBNO: Nikoli ne spreminjajte elementov in uporabljajte le izstrelke, ki so bili priloženi tej igrači.  
 RO IMPORTANT: Nu modificați niciodată elementele și nu utilizați alte proiectile decât cele furnizate cu această jucărie.  
 BG ВАЖНО: Не видоизменяйте елементите и не използвайте други снаряди освен приложените към тази играчка.  
 LV SVARĪGĪ! Nekad nepārveidojiet rotallietas elementus, vienmēr izmantojiet tikai tās komplektā iekļautās lodītes.  
 ET OLULINE: Mänguasja osi ei tohi teistega asendada, kasutada võib ainult kaasasolevat heitkeha.  
 LT DĖMESIO! Nekuomet nekeiskite elementų ir naudokite tik tuos šovinius, kurie yra pridėti prie šio žaislo.  
 TR ÖNEMLİ: Hiçbir zaman parçalarda değişiklik yapmayın veya bu oyuncakla sağlananlar dışında mermiler kullanmayın.

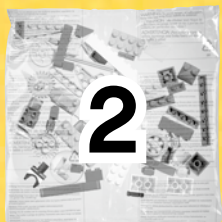

+

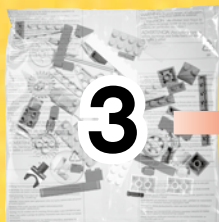

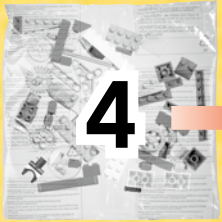

4

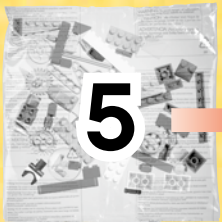
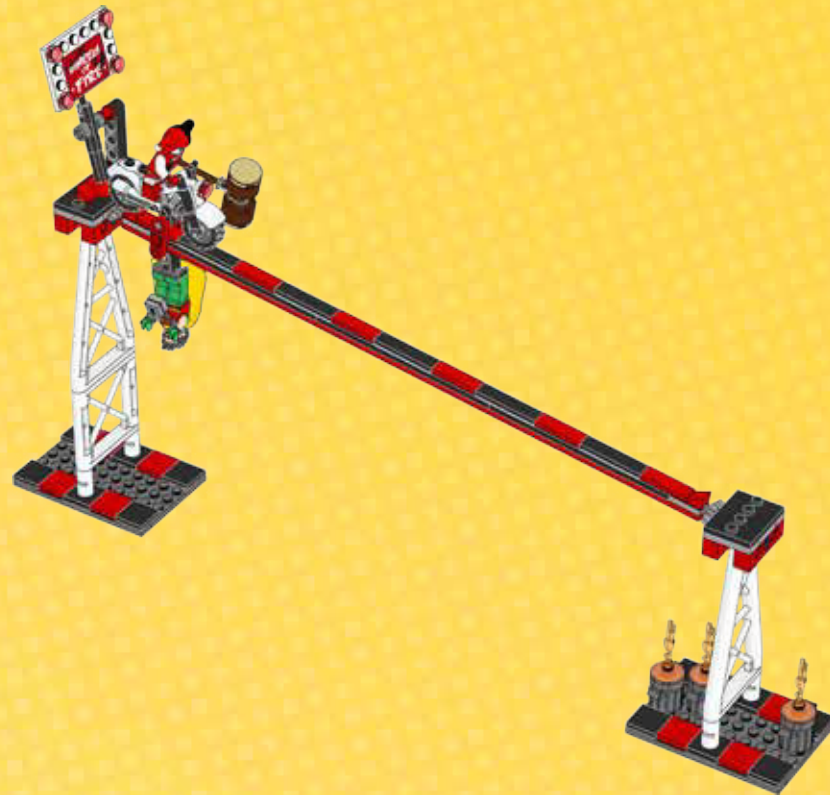

5

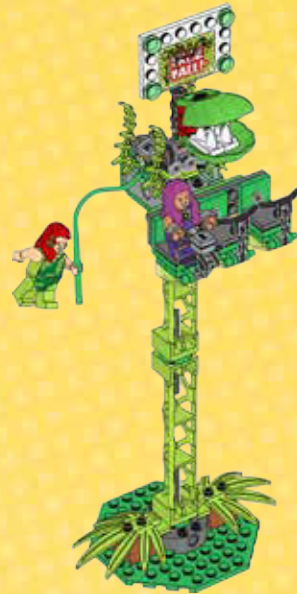



+

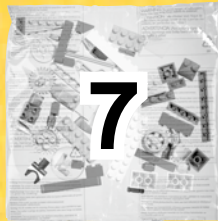

+



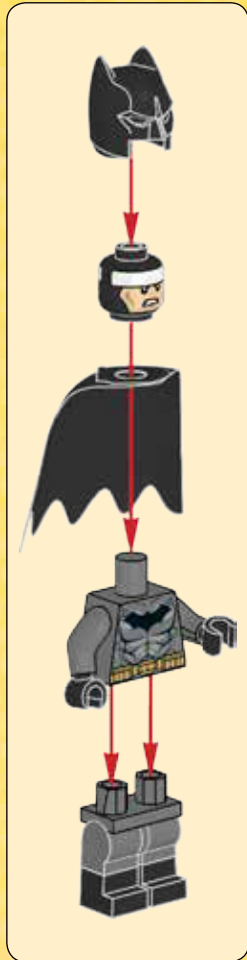

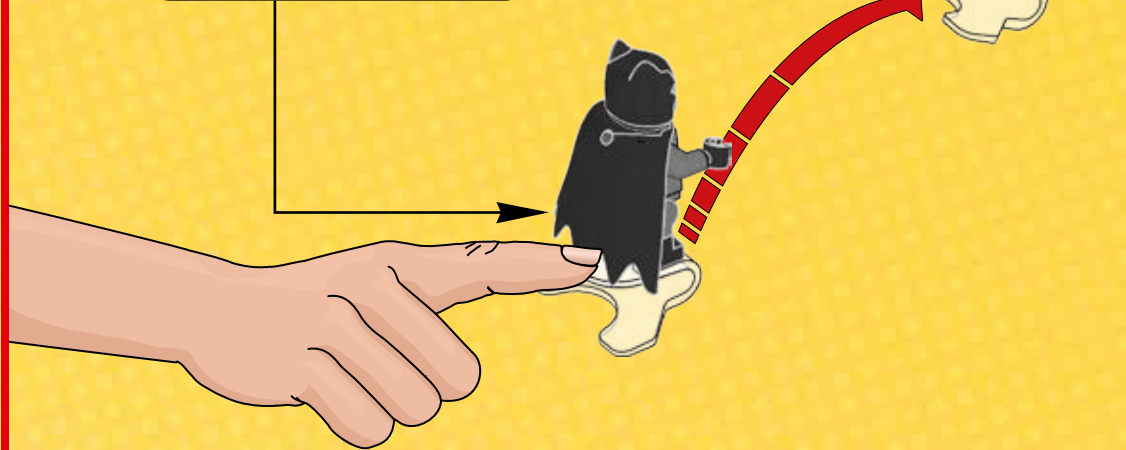
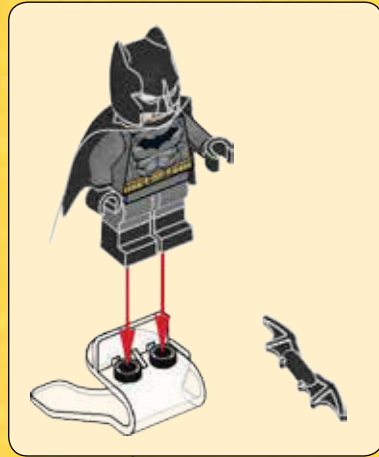



1x

1



2x

2



1x



1x

3



2x

4

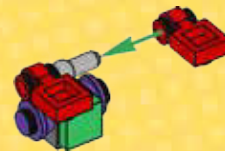



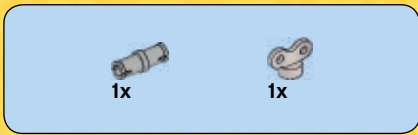

5

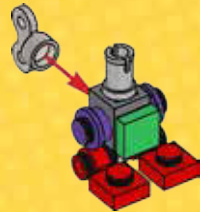

6

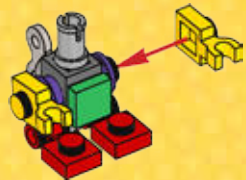

7

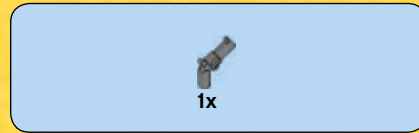
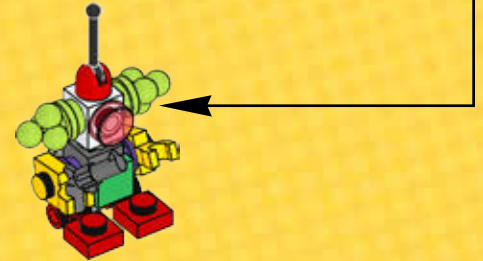

8





1x



1x

1



1x



1x

2

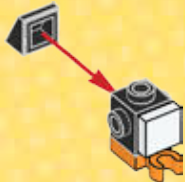

1x



1x

3

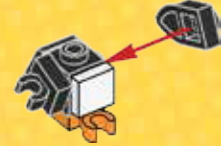

1x



1x

4



1x

5



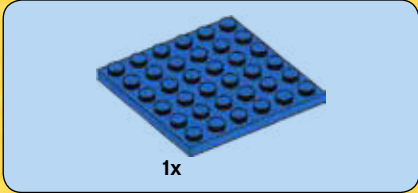
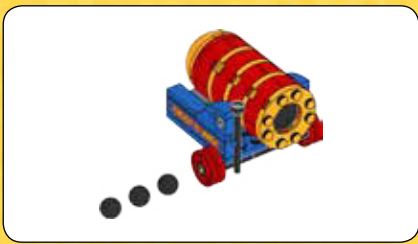

1

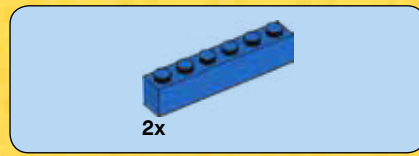

2

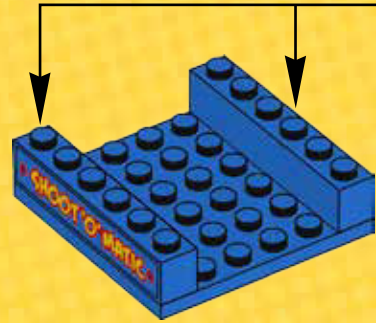

3

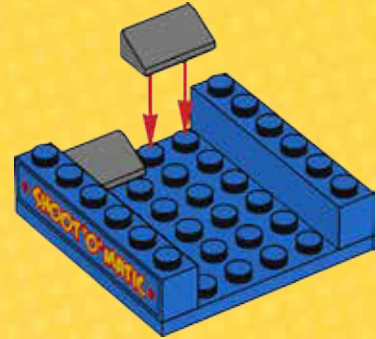



# 4

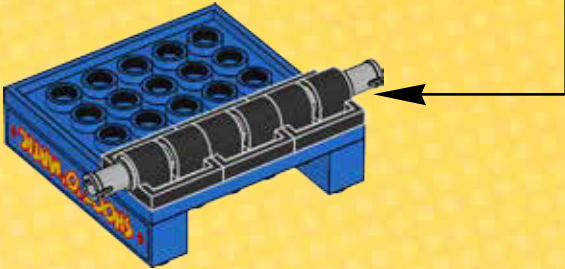
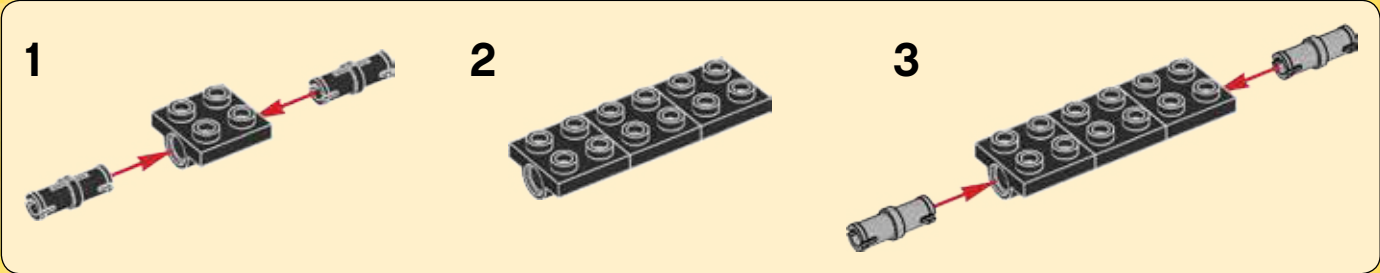



5

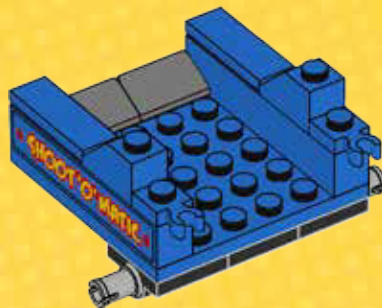
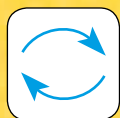



1



2



3





4

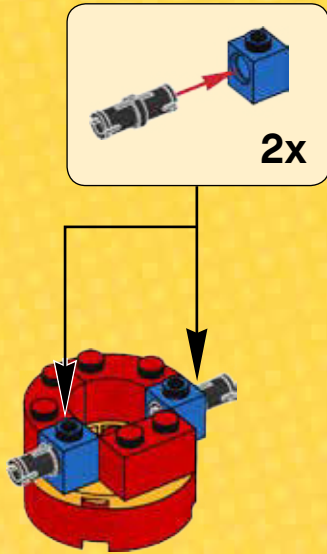

5

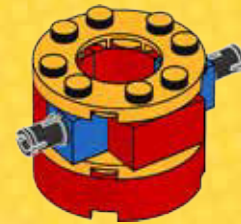

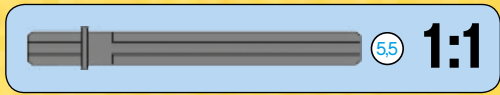
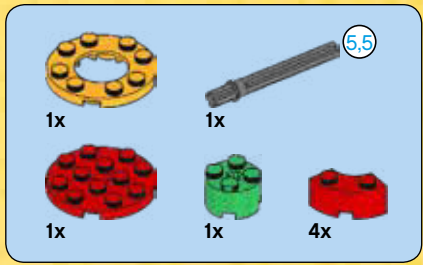

6

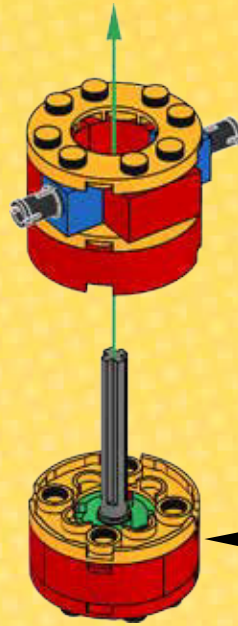
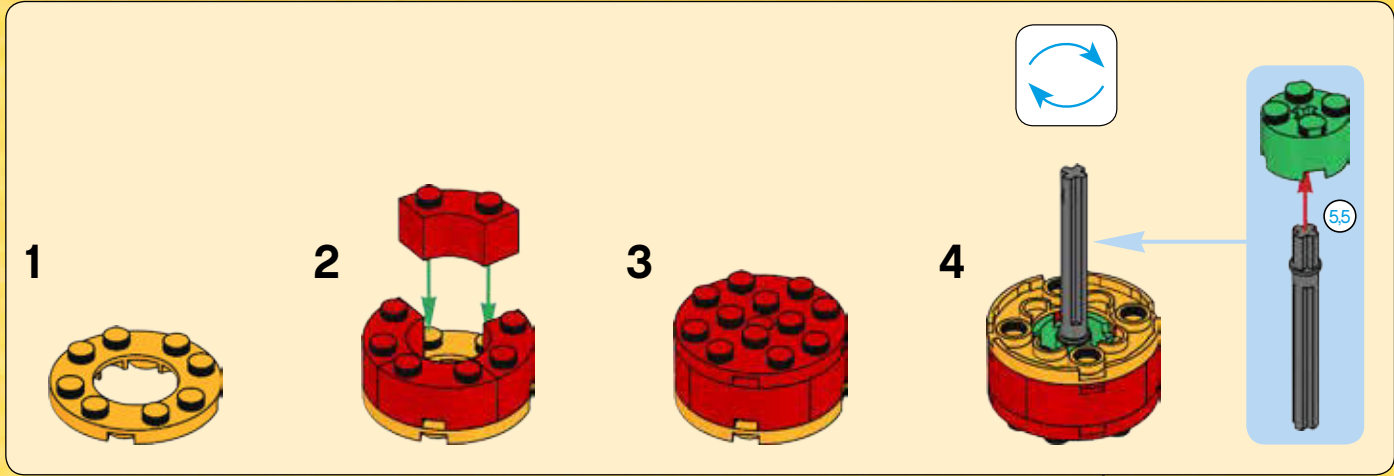



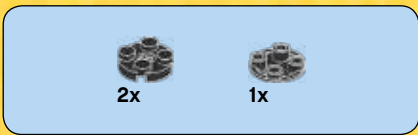

7

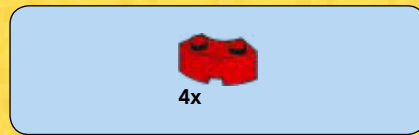
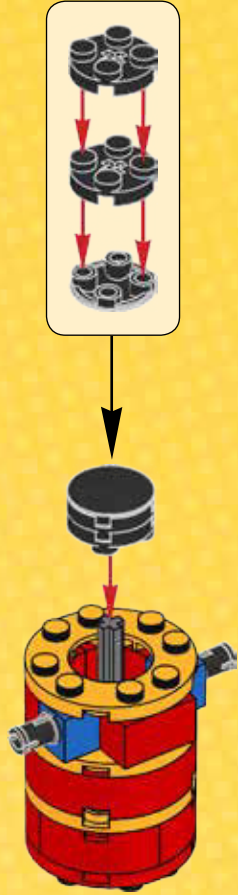

8

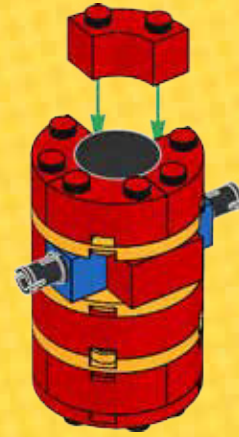

9

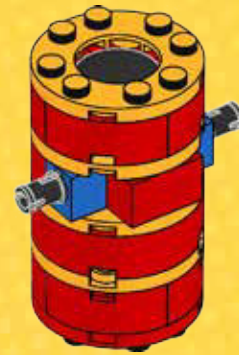



2x

10

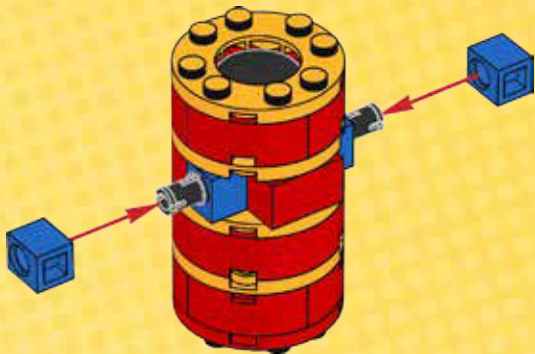

1x

11

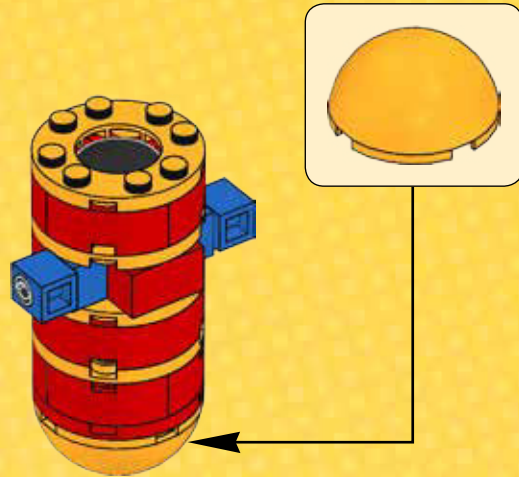

6

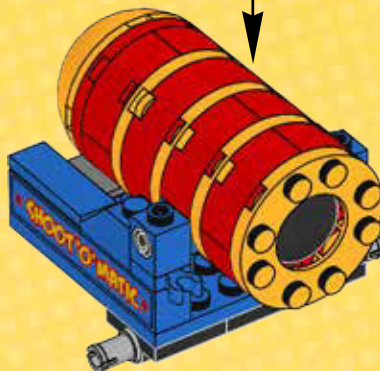



2x

7

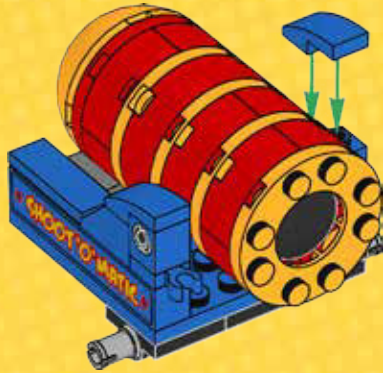

2x

8

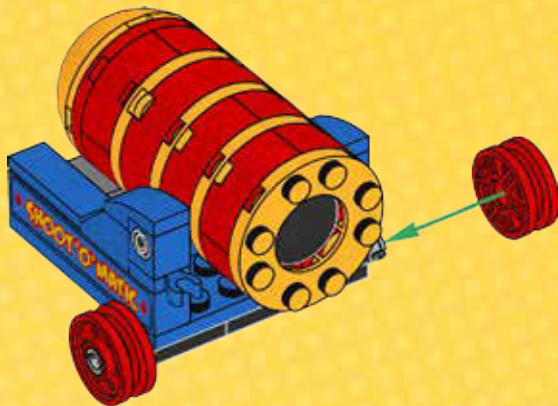

1x



3x

9

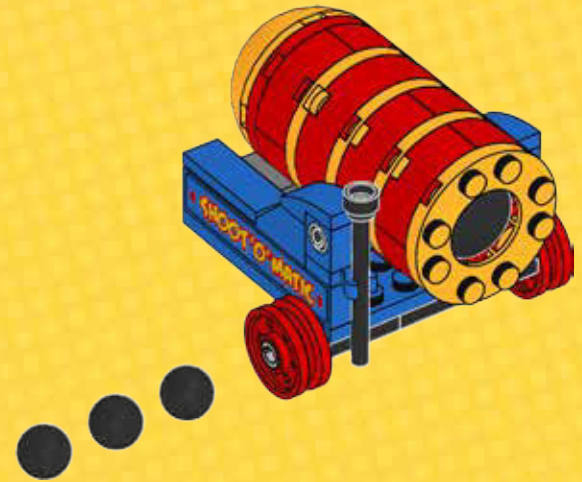

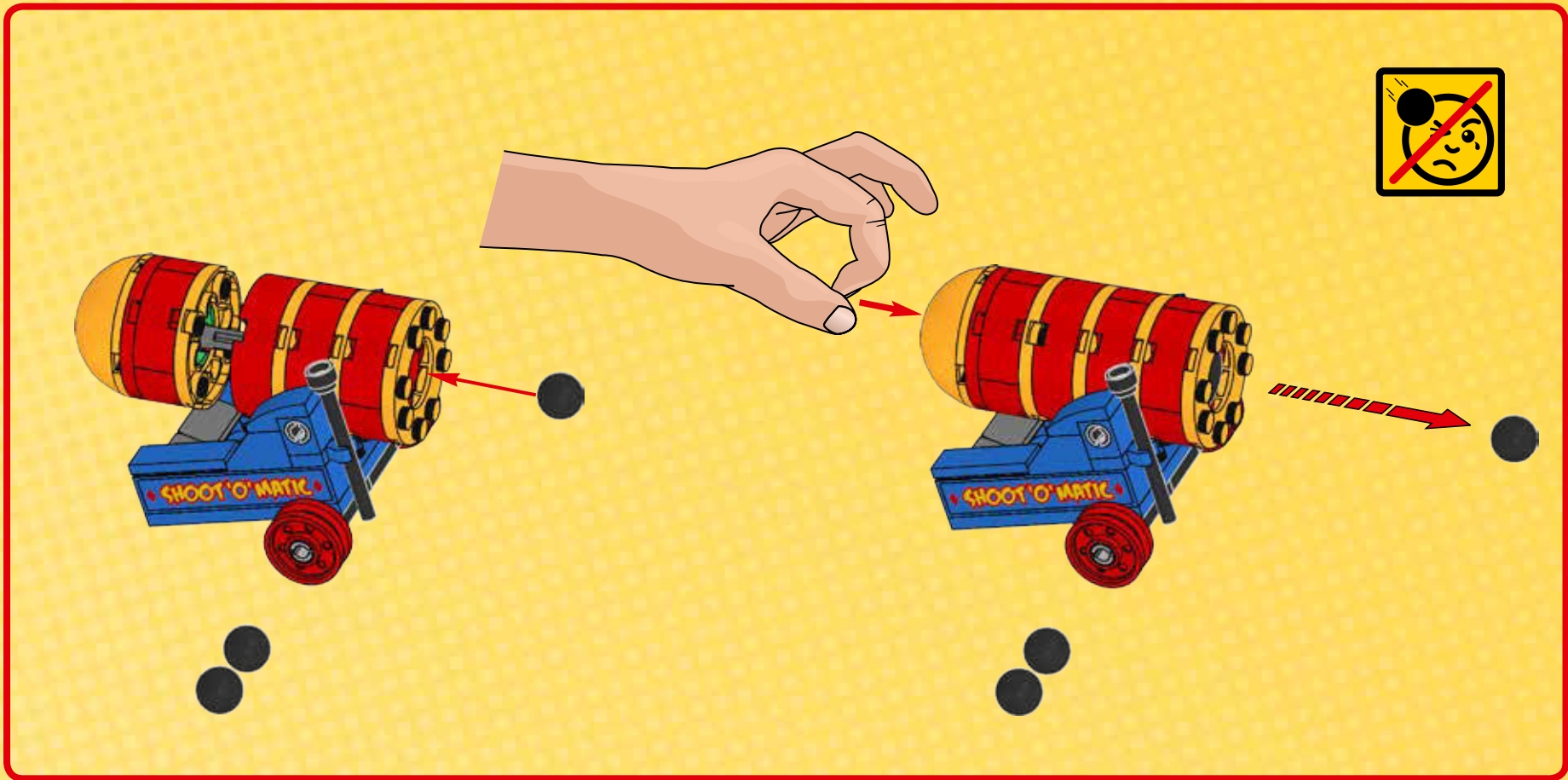

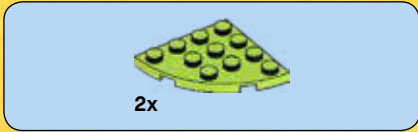

1

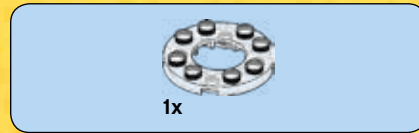
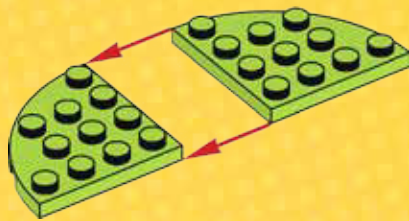

2



3



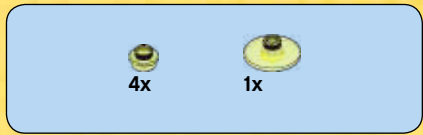

4

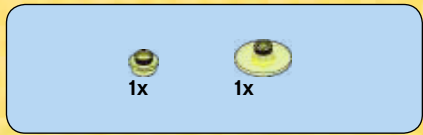
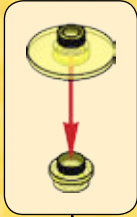

5

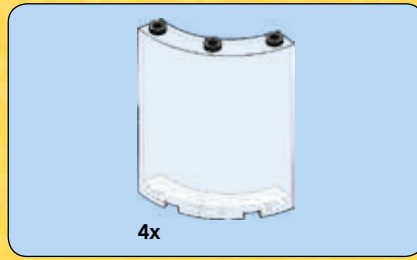
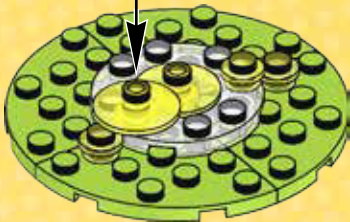
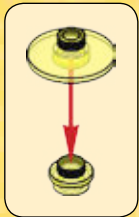

6



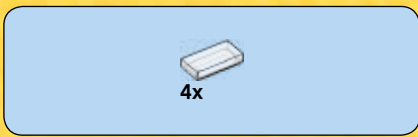

7



8

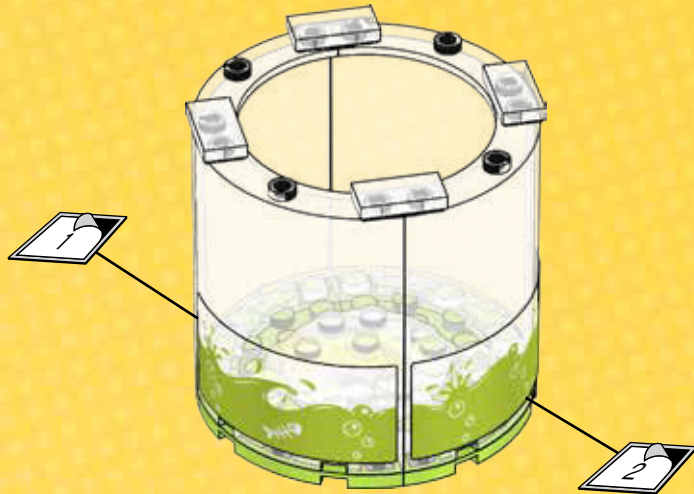

9

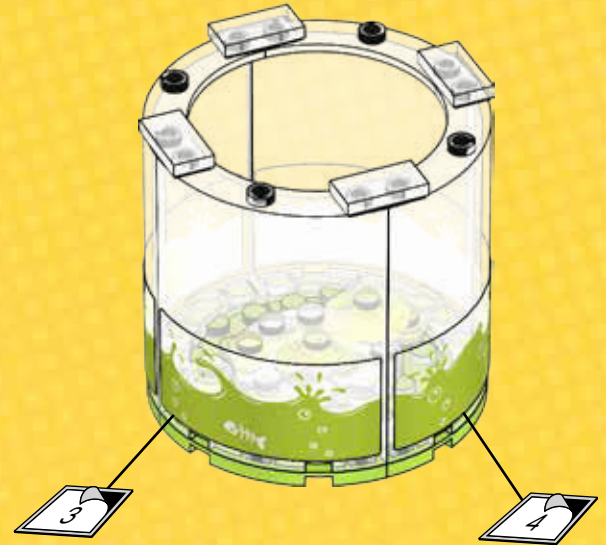

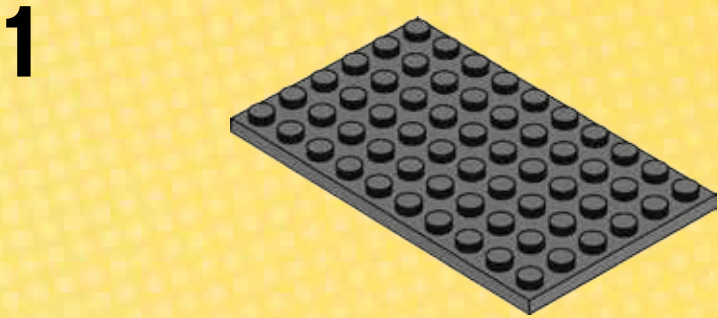
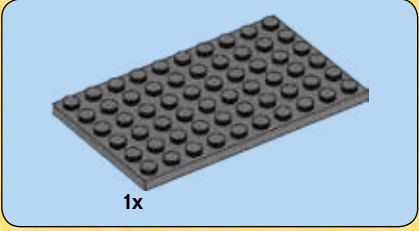
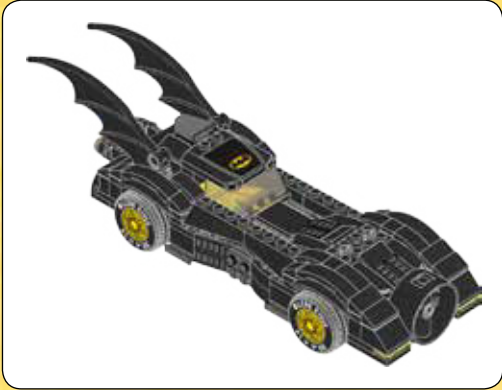
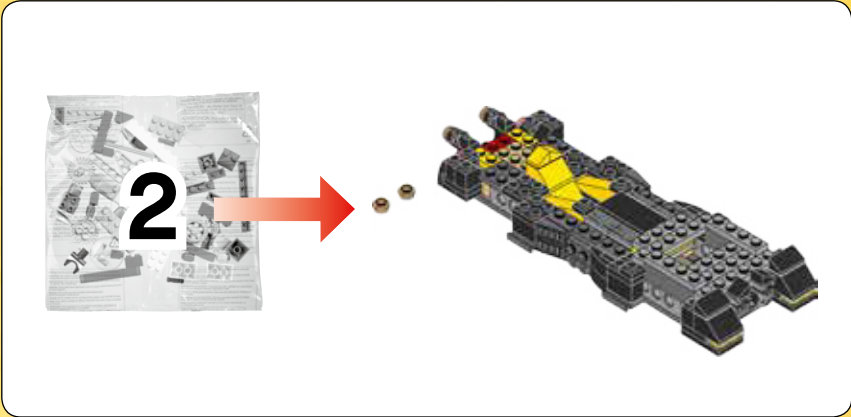

2

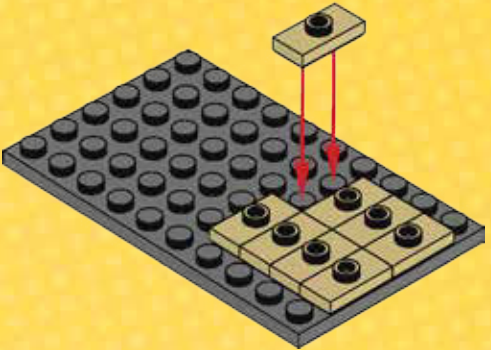

3

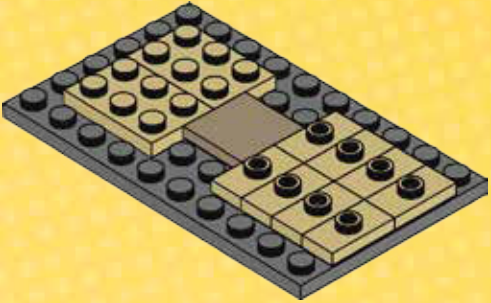



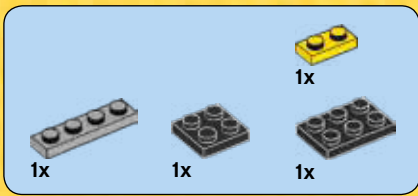

4

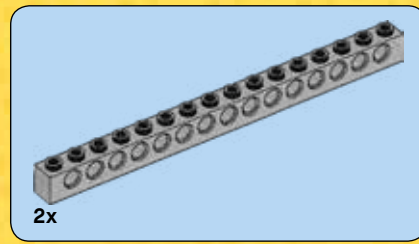
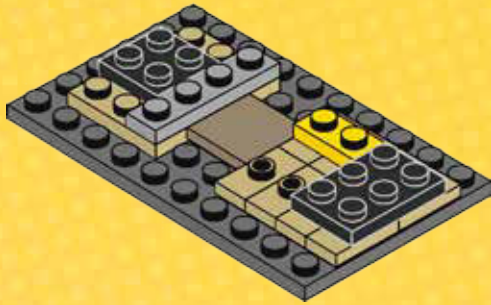

5

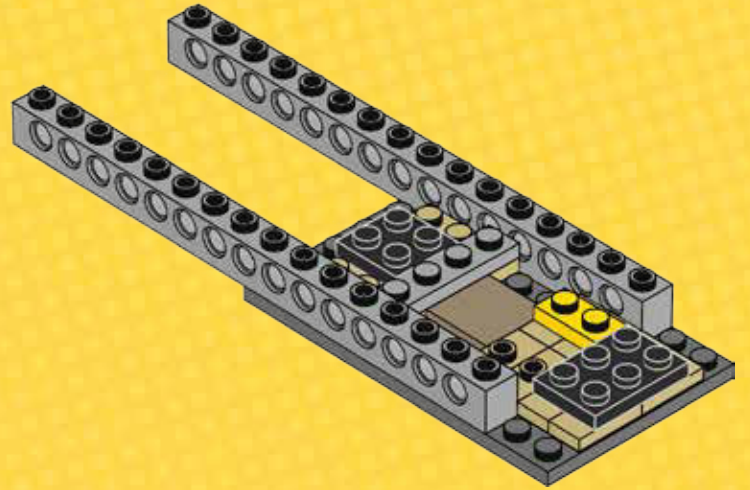

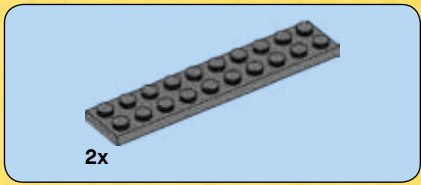

6

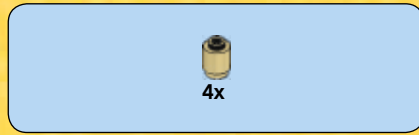
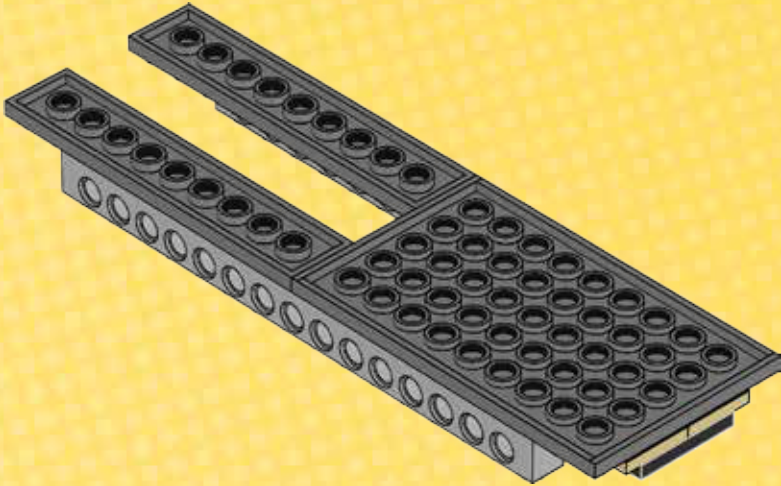

7

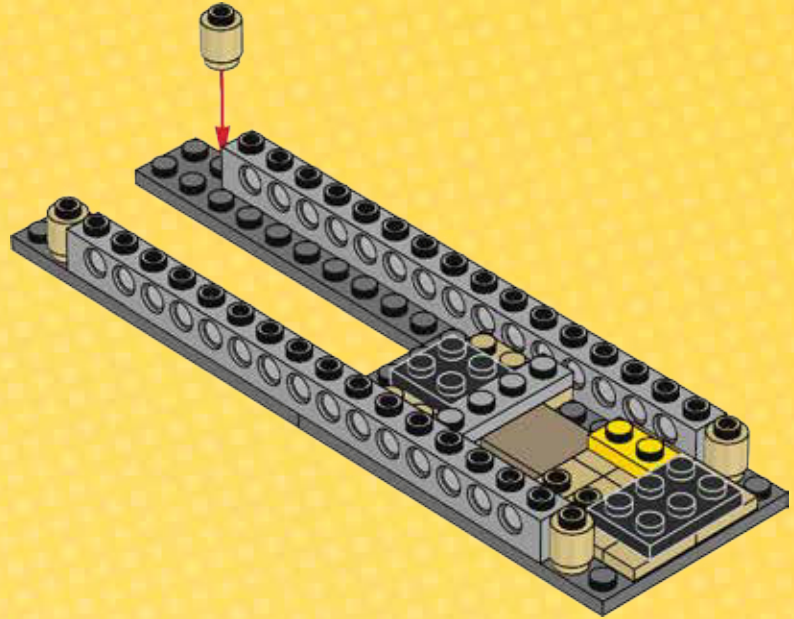

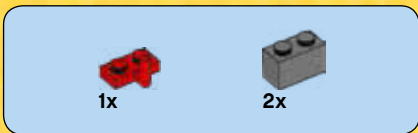

8

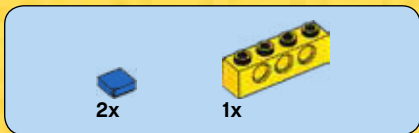
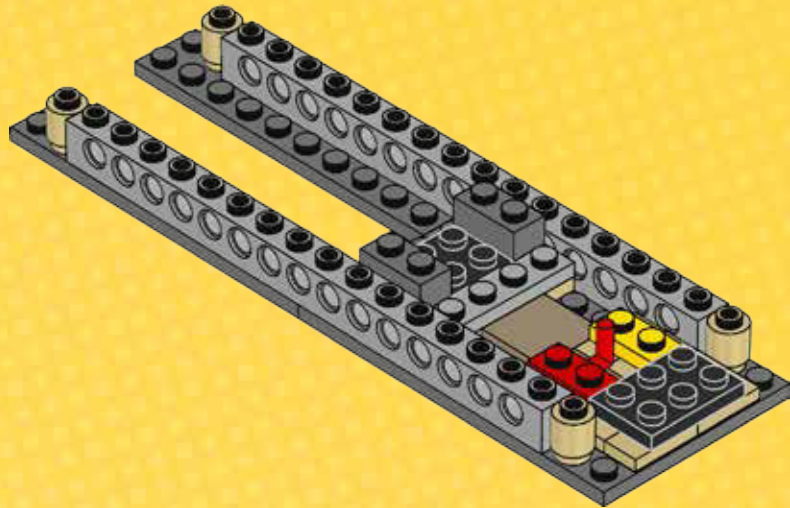

9

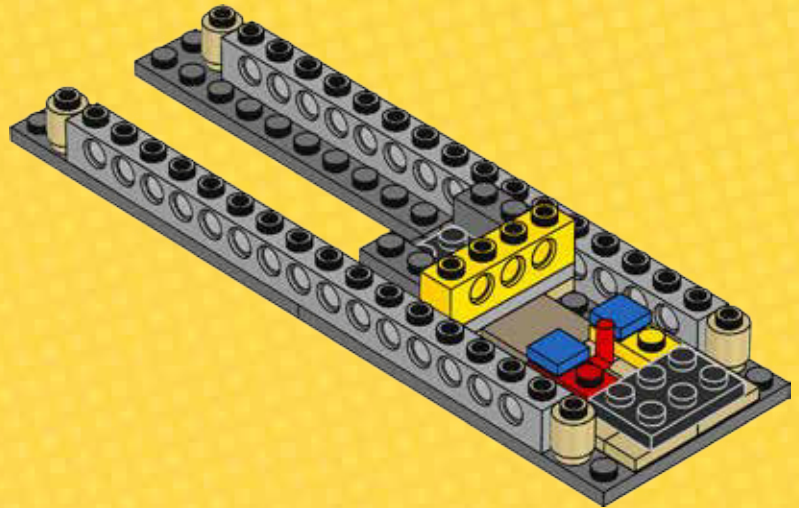

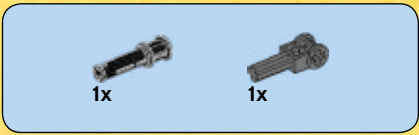

# 10

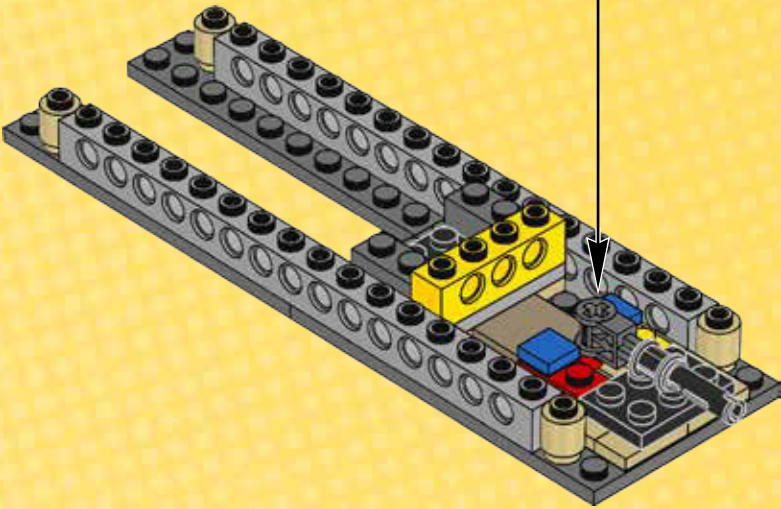
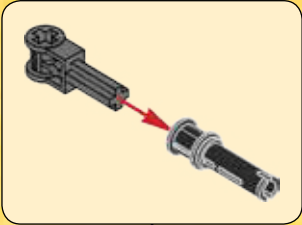

# 11

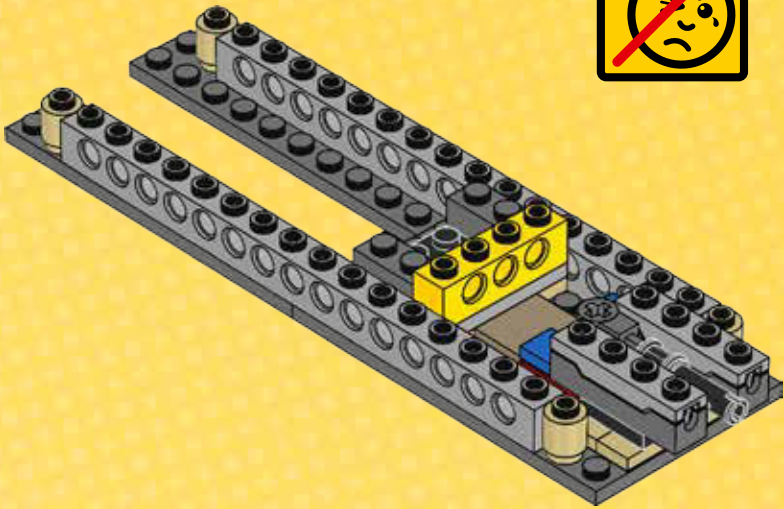

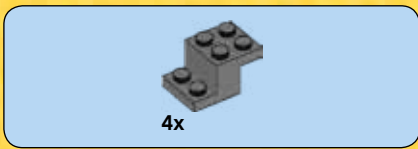

12

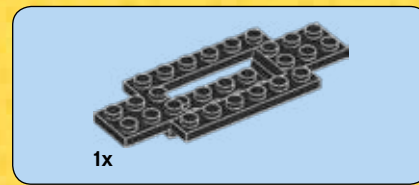
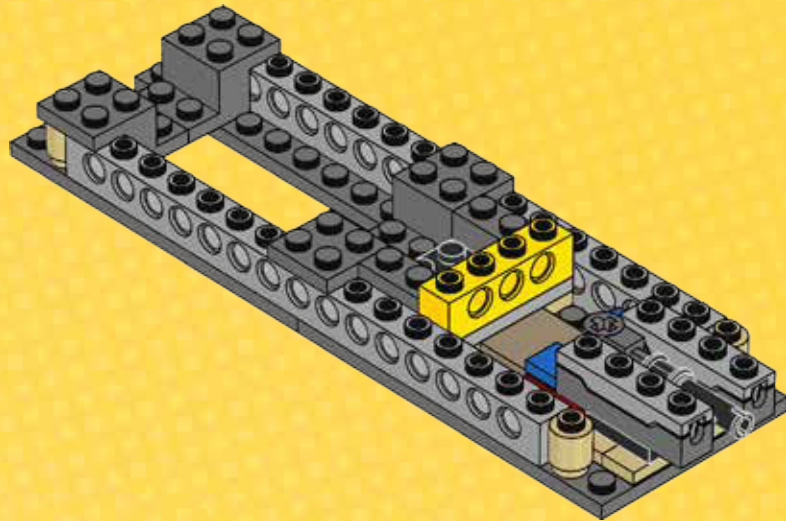

13

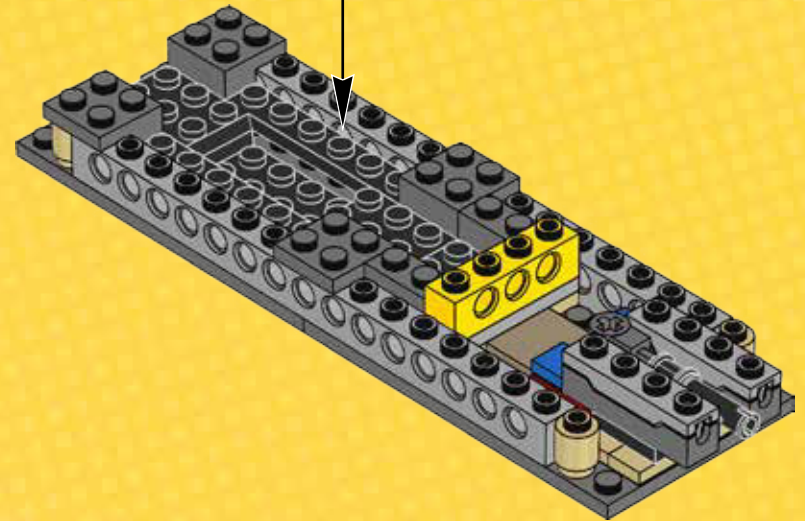
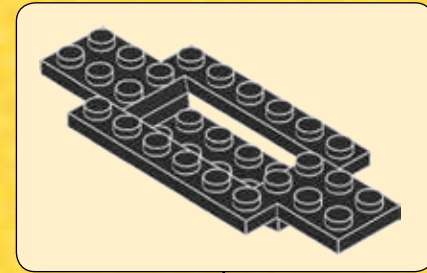

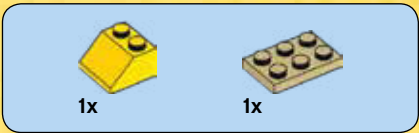

# 14

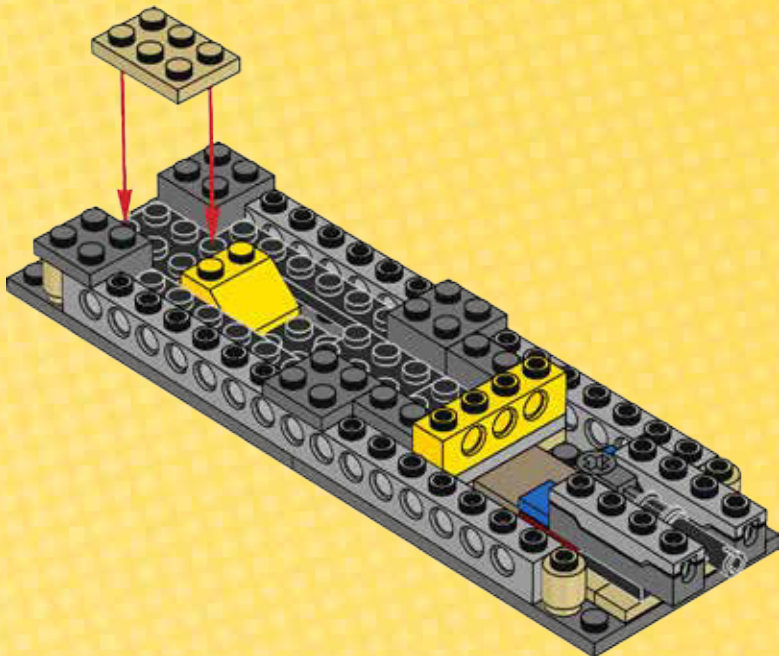

# 15

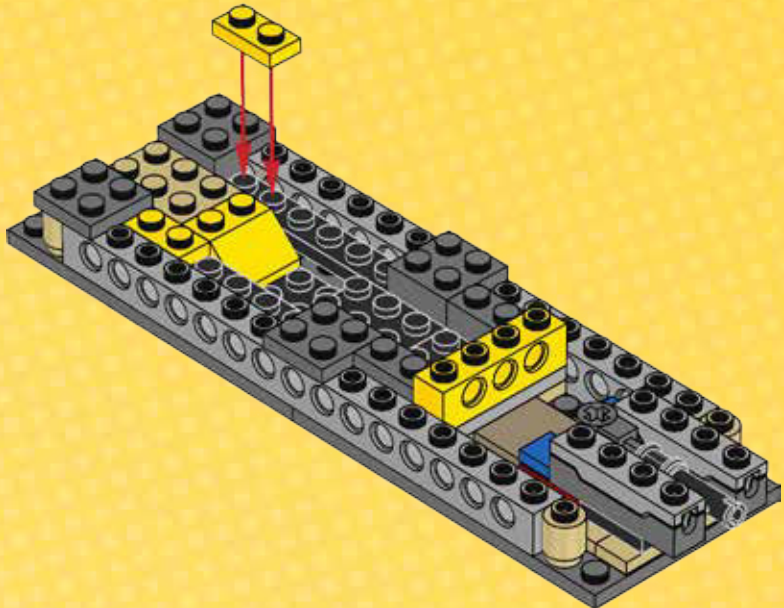



16

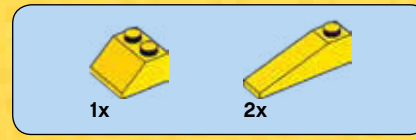
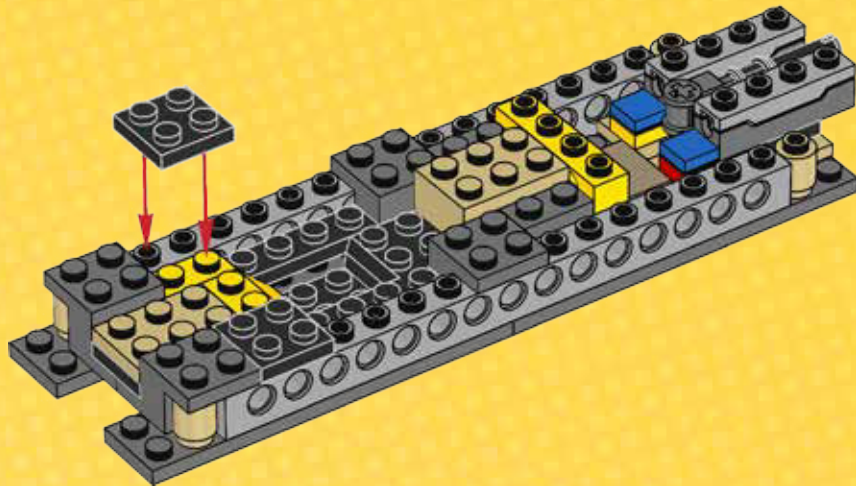

17

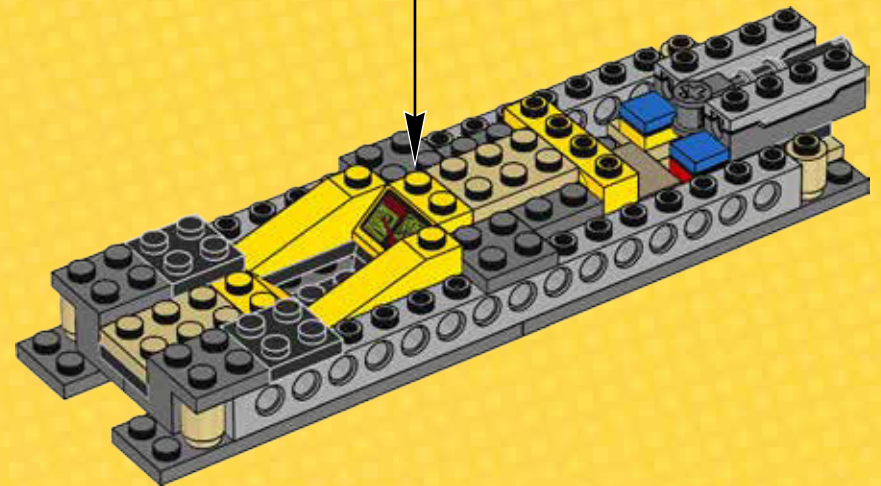
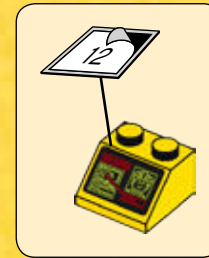

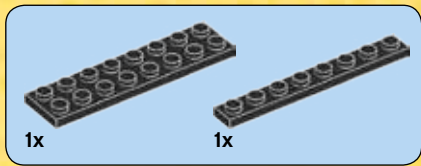

1

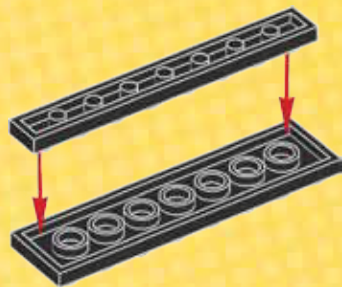

2

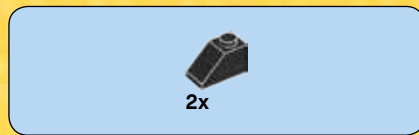
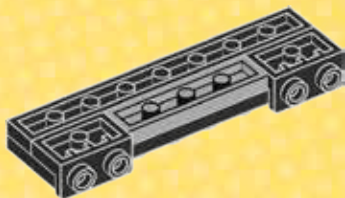

3

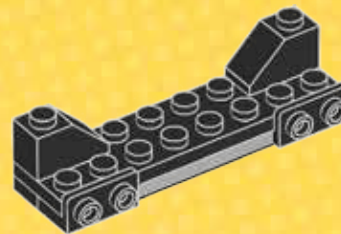

4

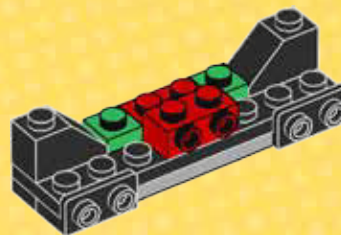





4x

5

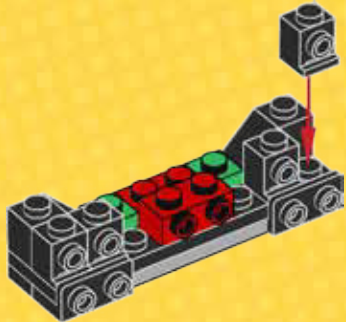

4x

6

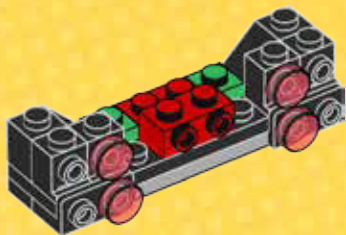

2x

7

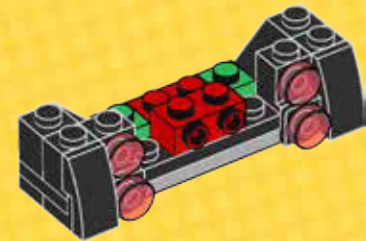

2x



2x

8

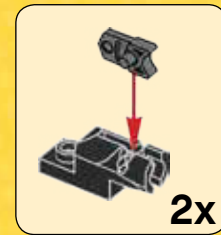

2x

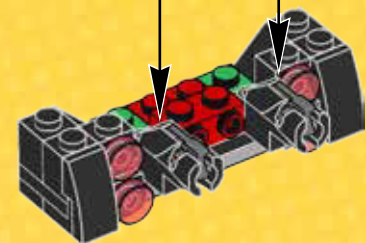



2x

9

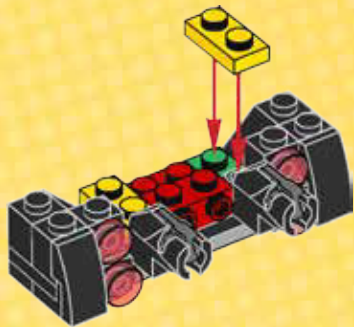

18

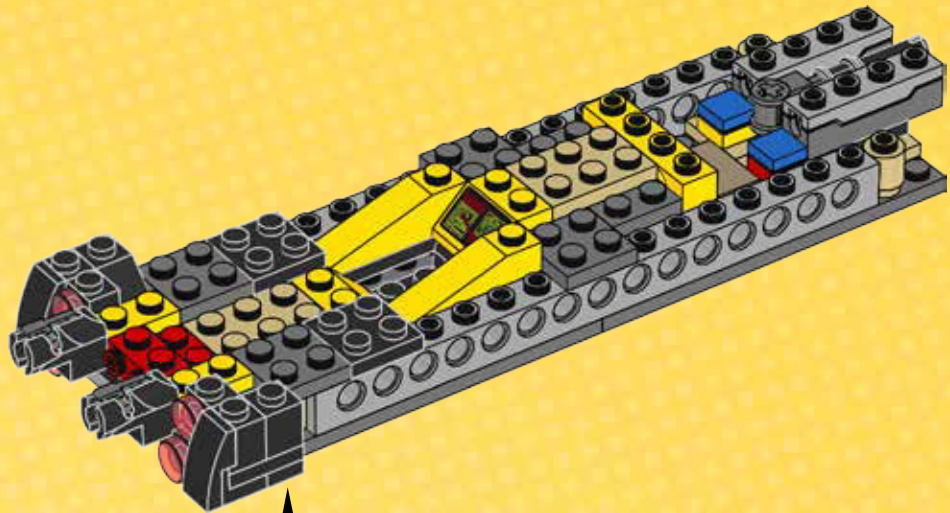



# 19

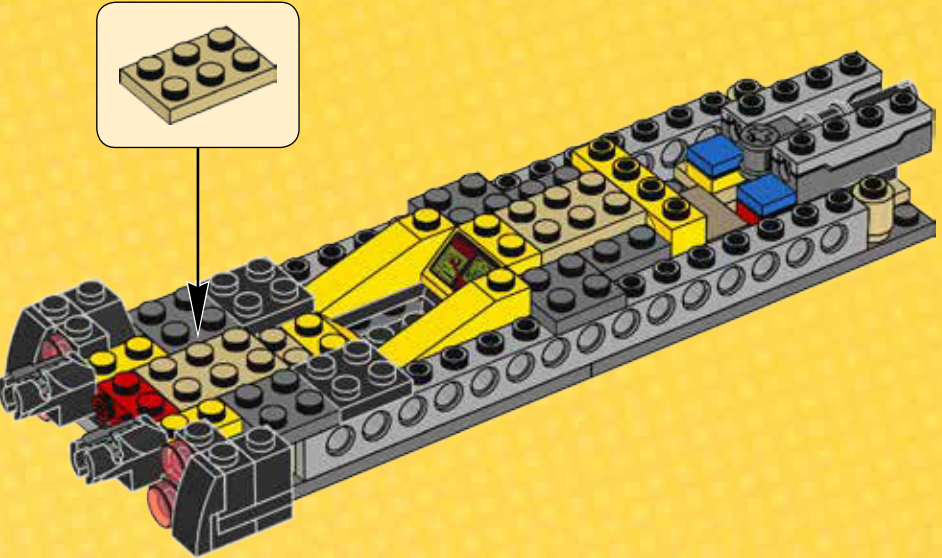

# 20

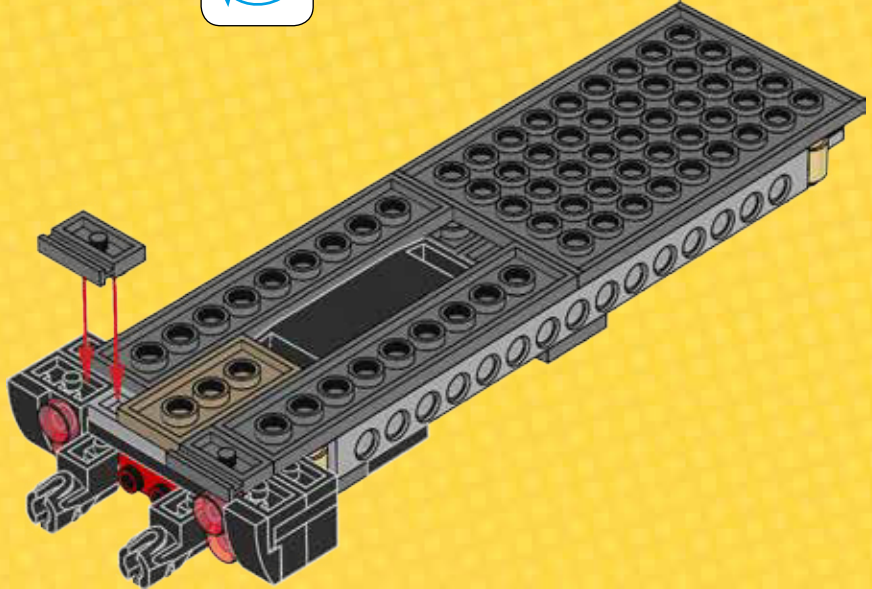



6x

# 21

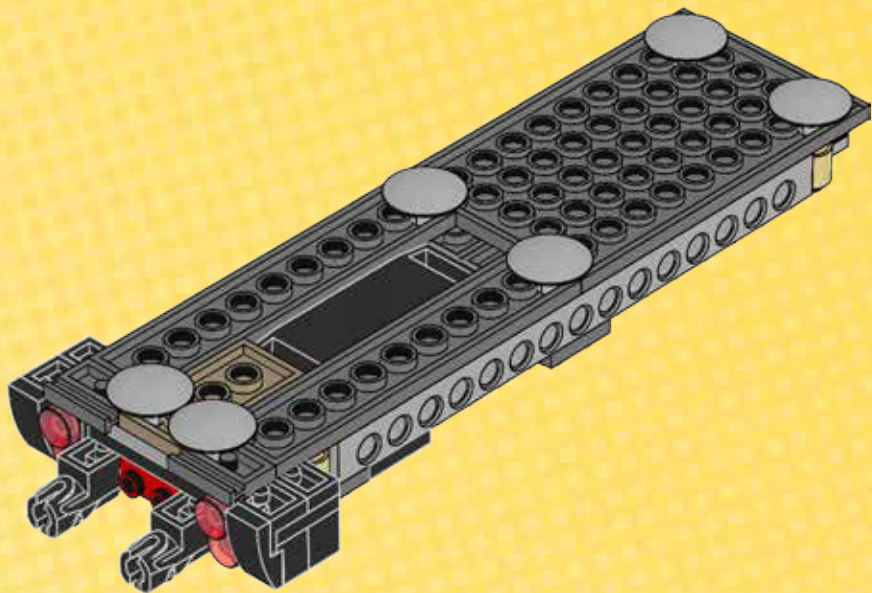

2x



1x

# 22

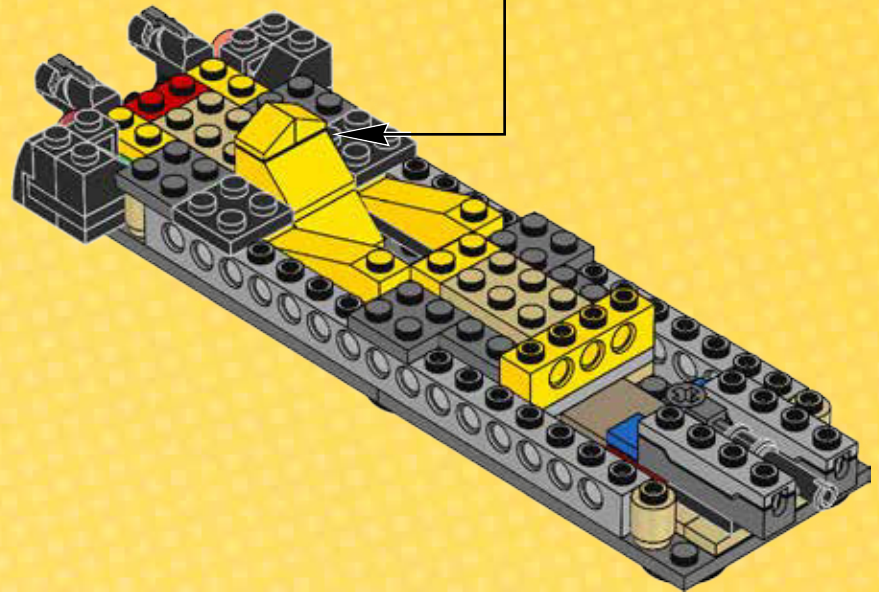
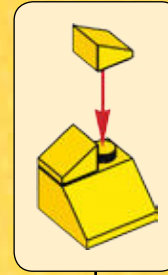



4x

# 23

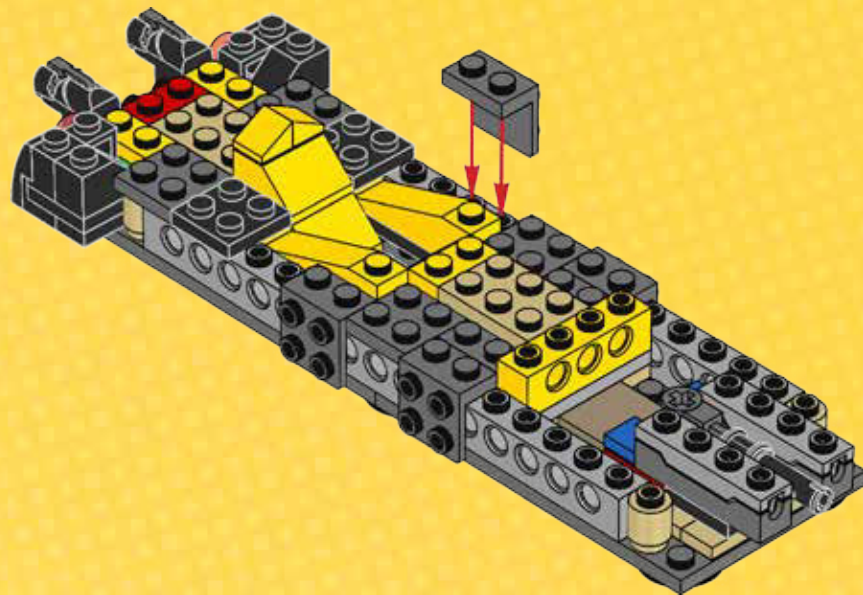

2x

# 24

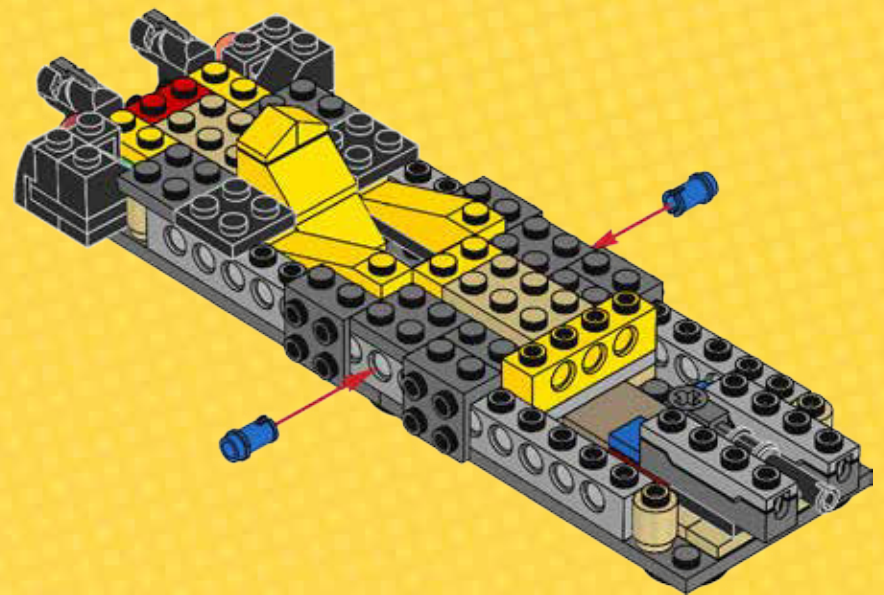



# 25

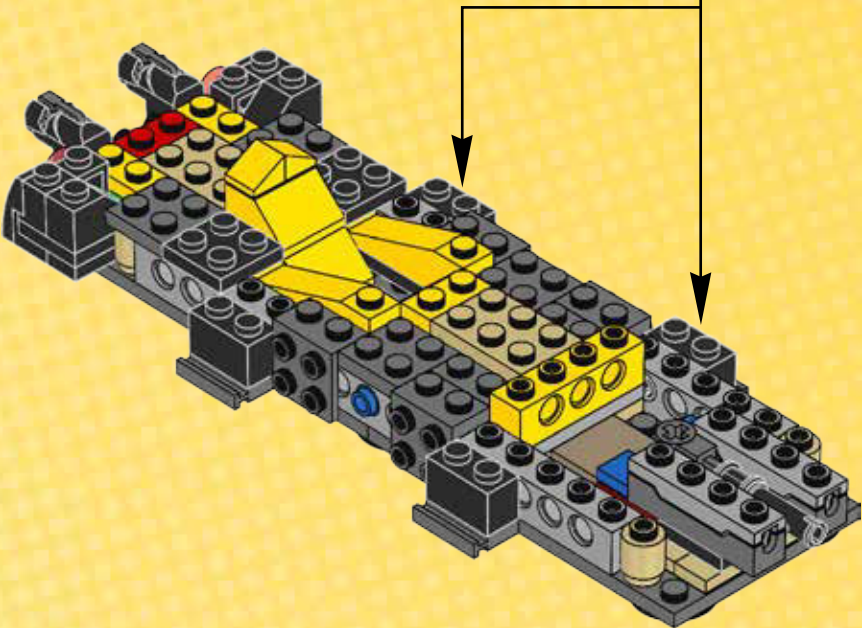
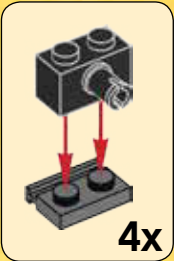

# 26

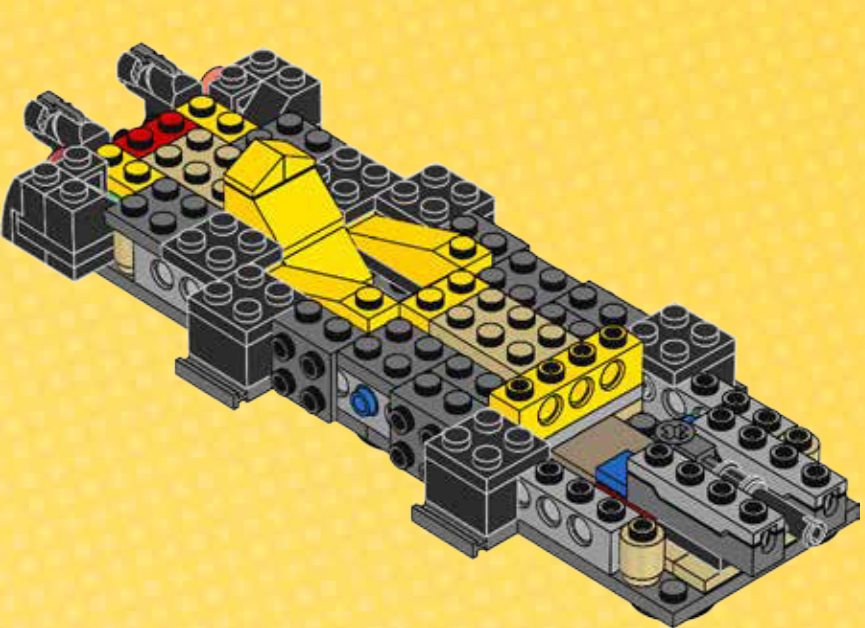



# 27

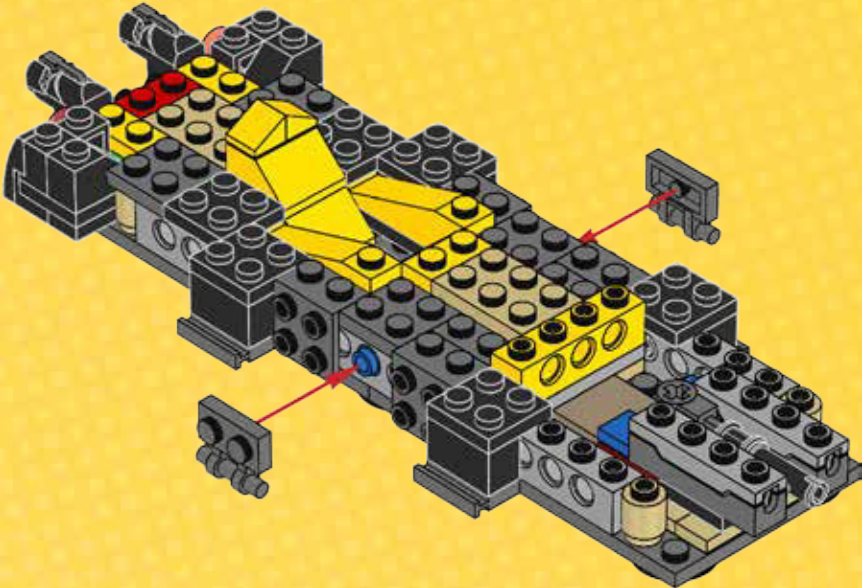

# 28

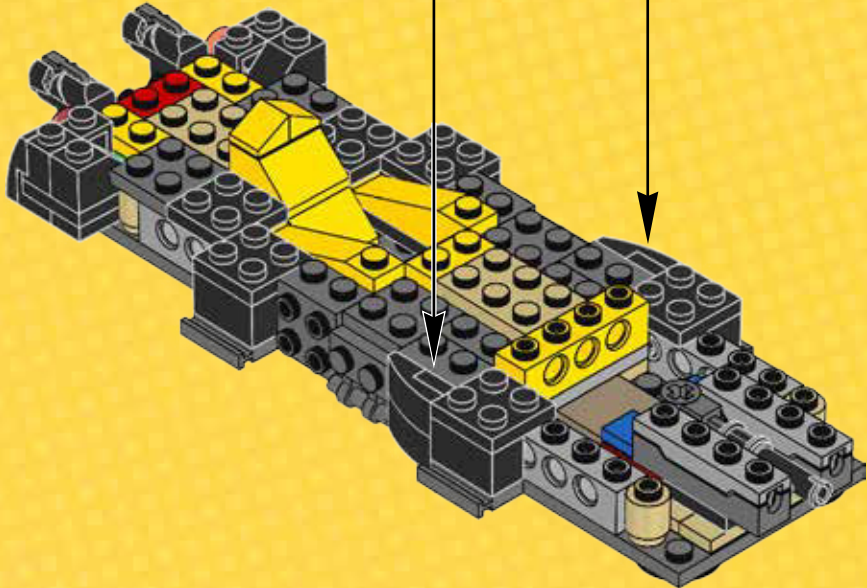
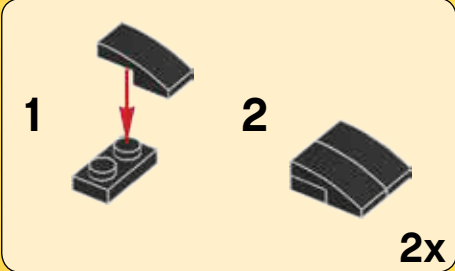



4x

# 29



4x

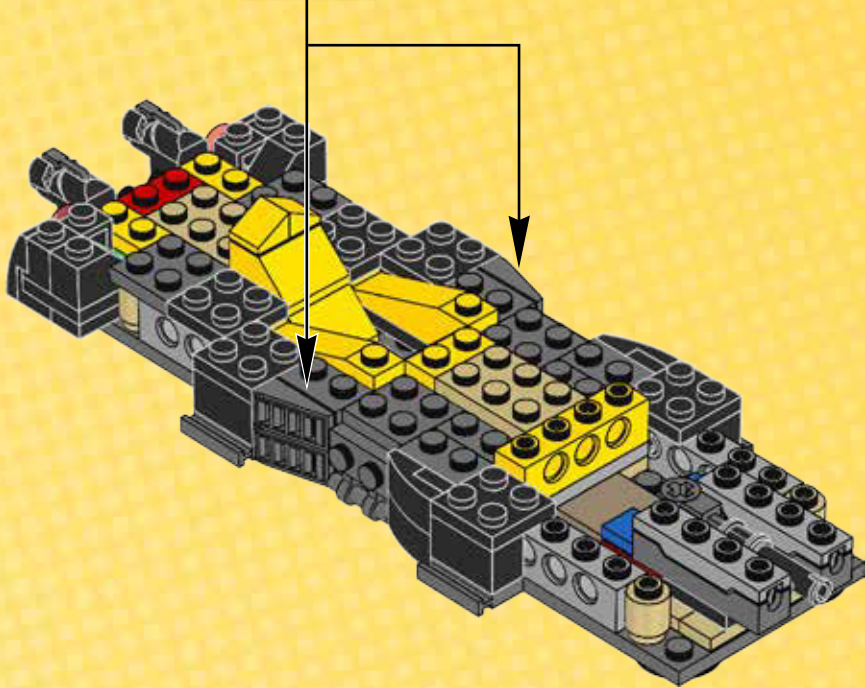

4x

# 30

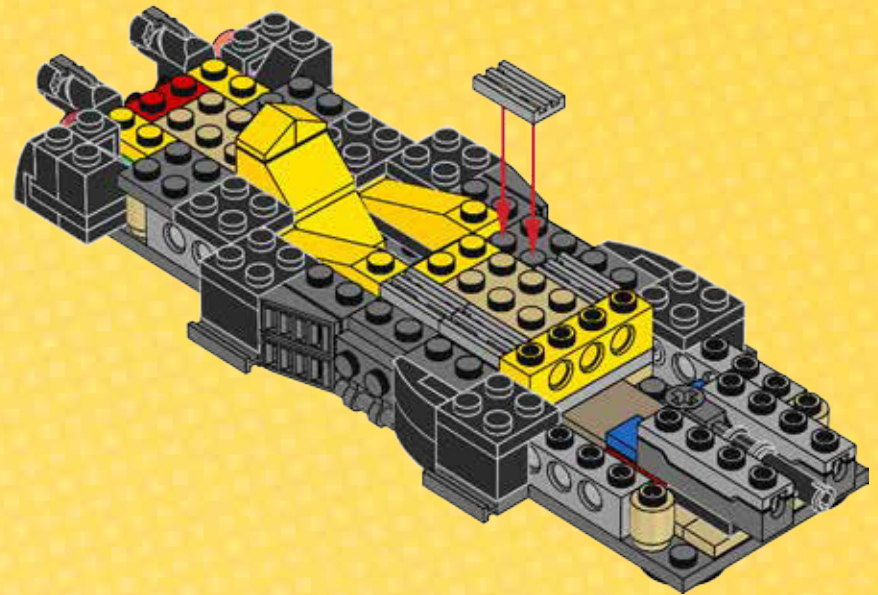



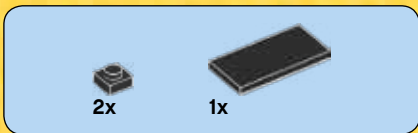

# 31

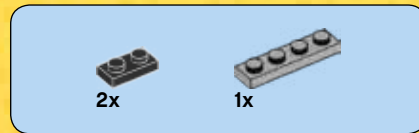
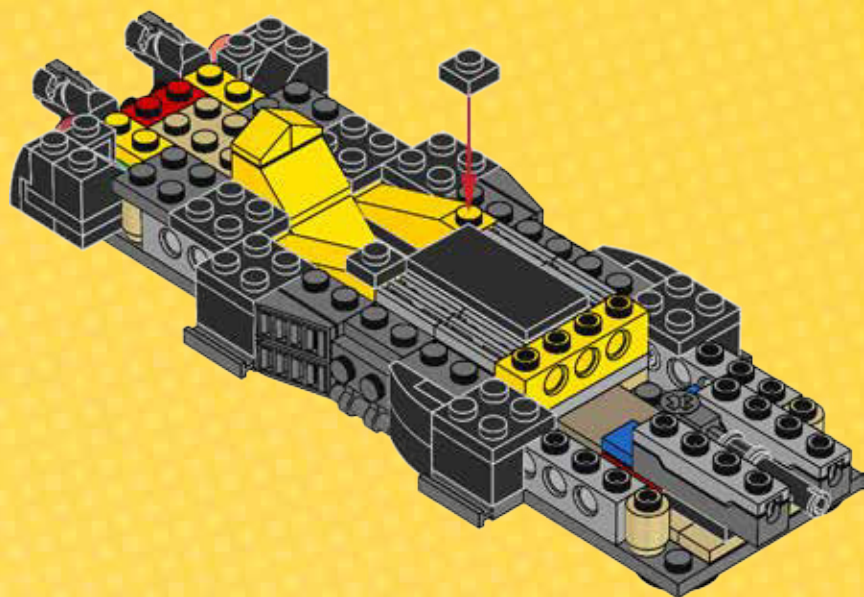

# 32

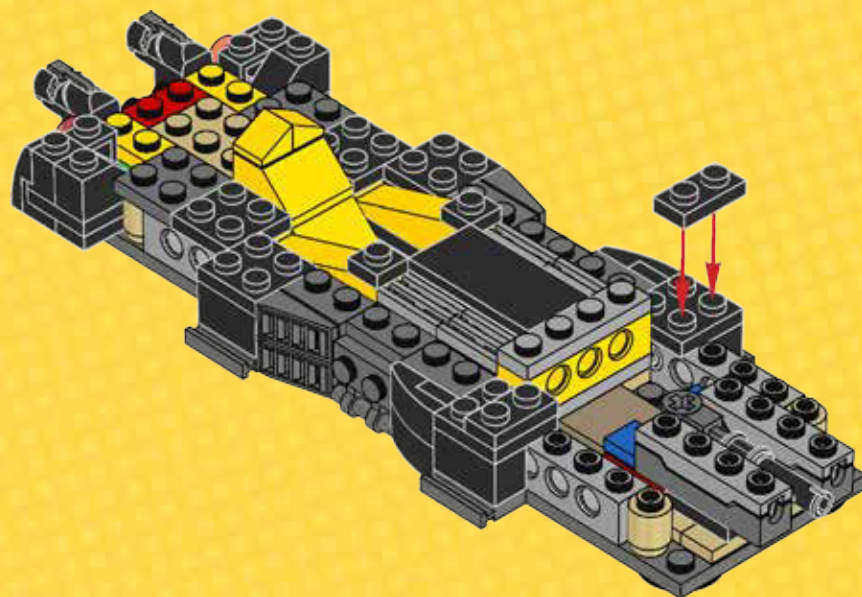

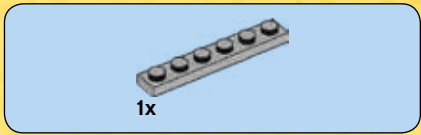

33

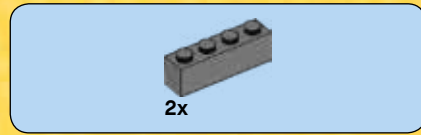
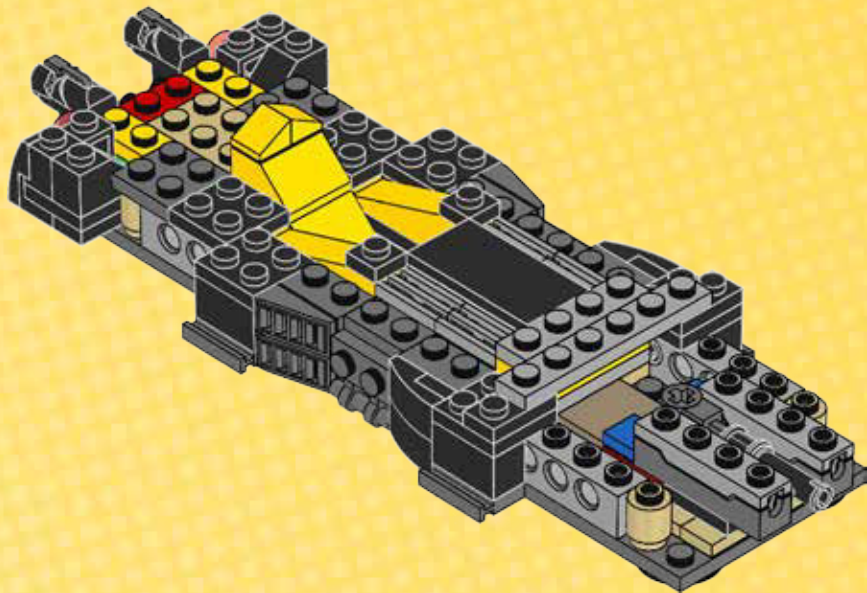

34

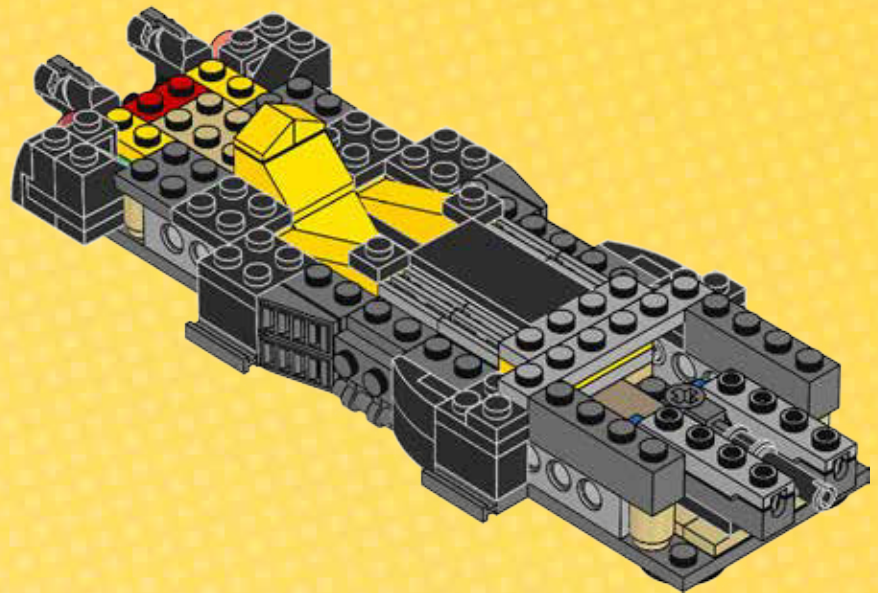



2x

# 35

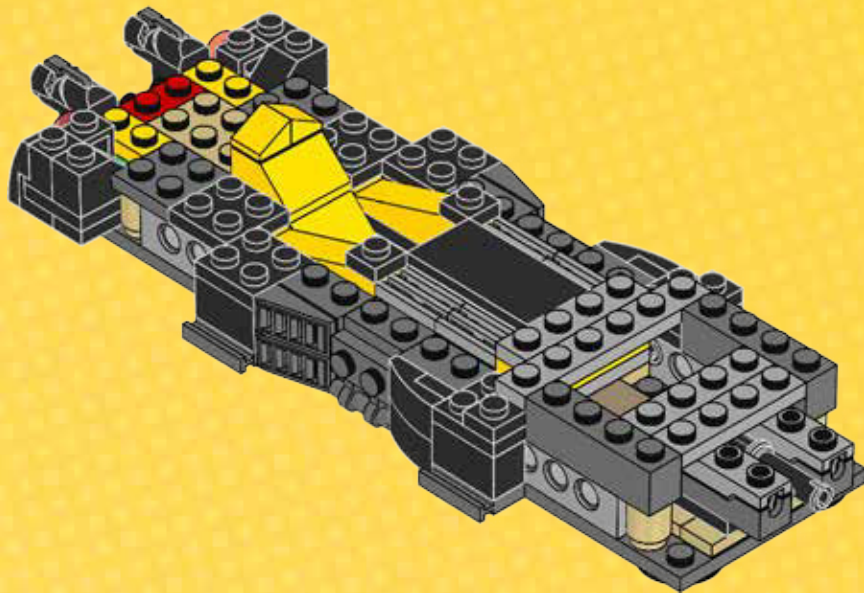

2x

# 36

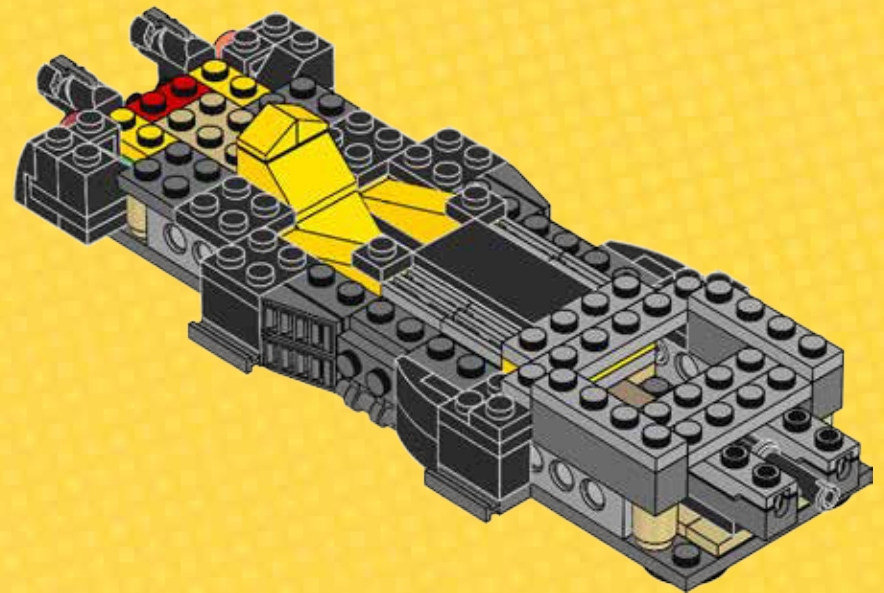

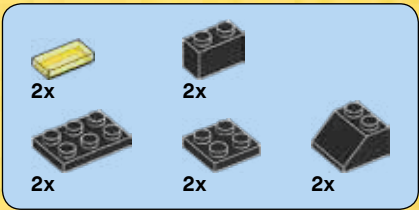

# 37

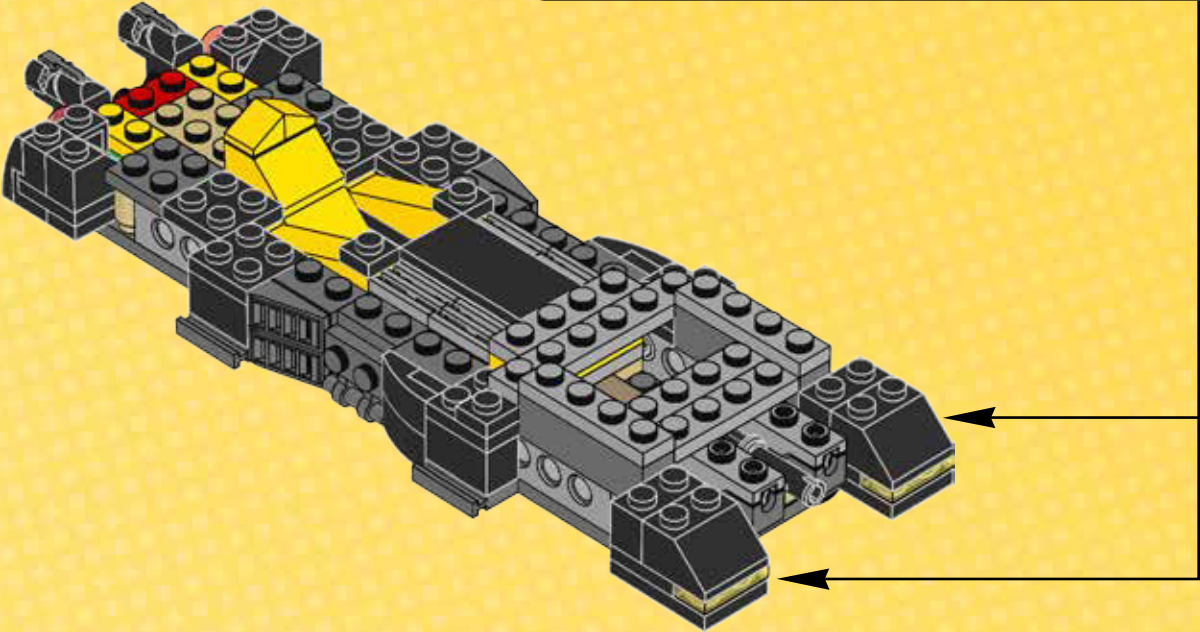
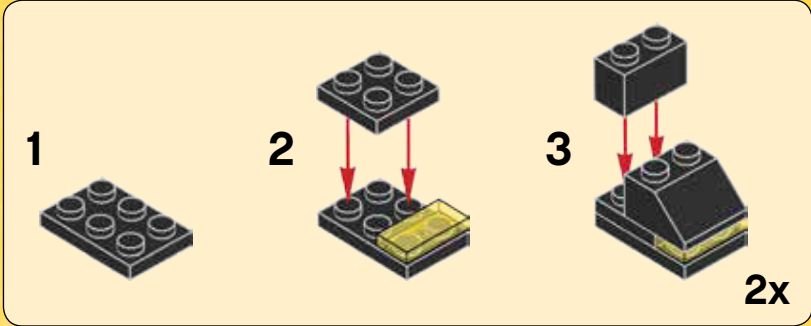

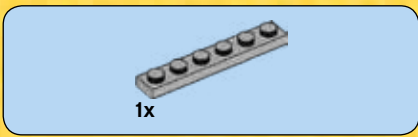

38

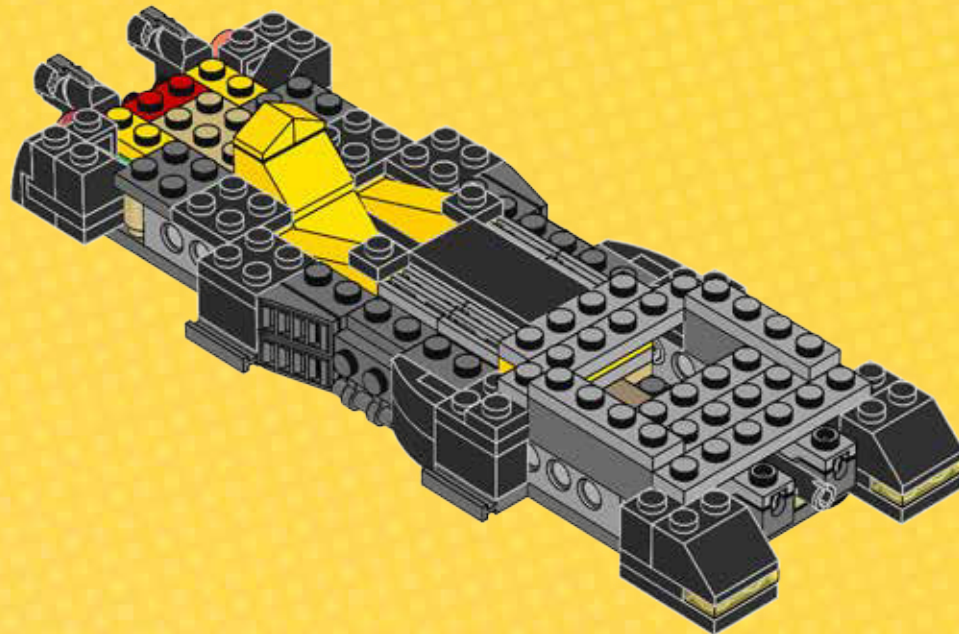





2x

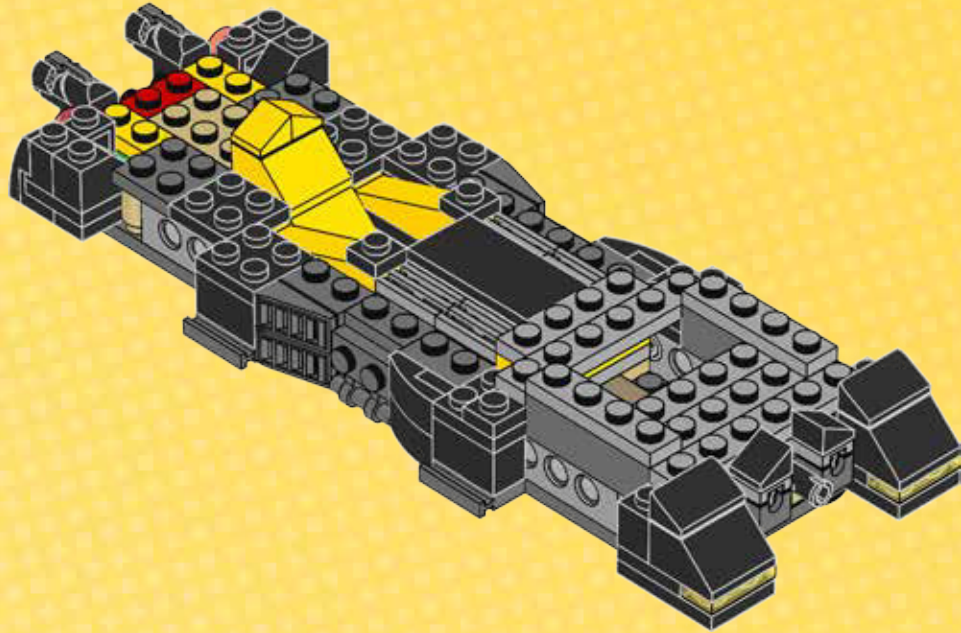

2x

# 39



  
4x

40

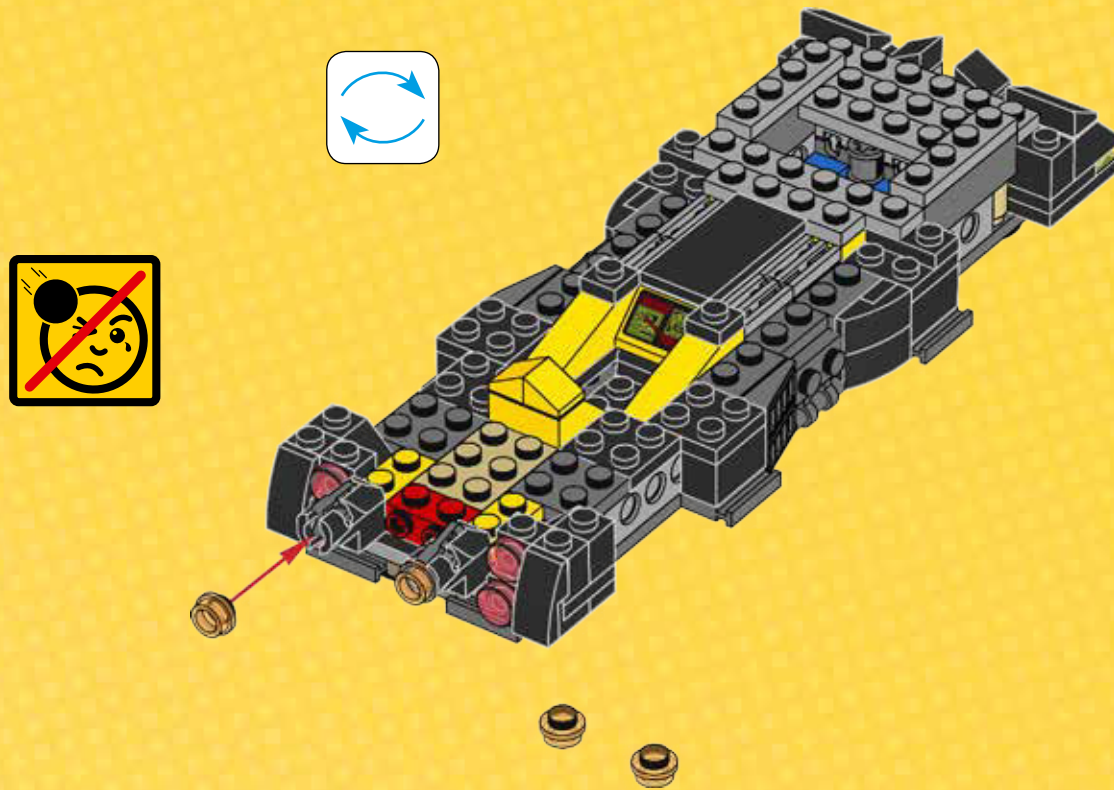

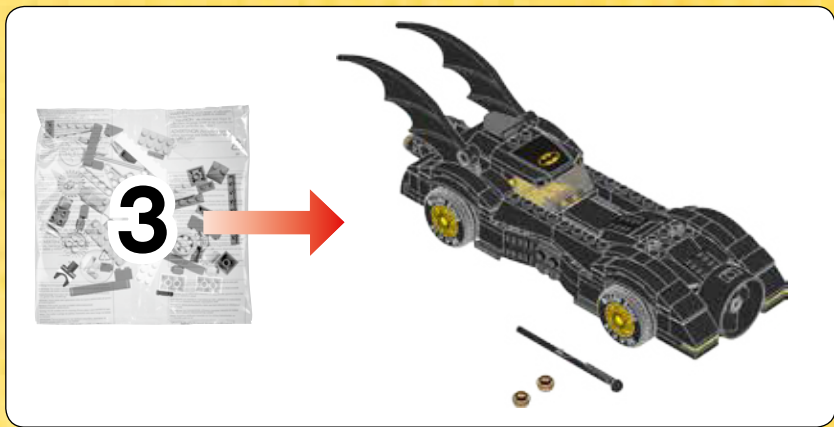

41

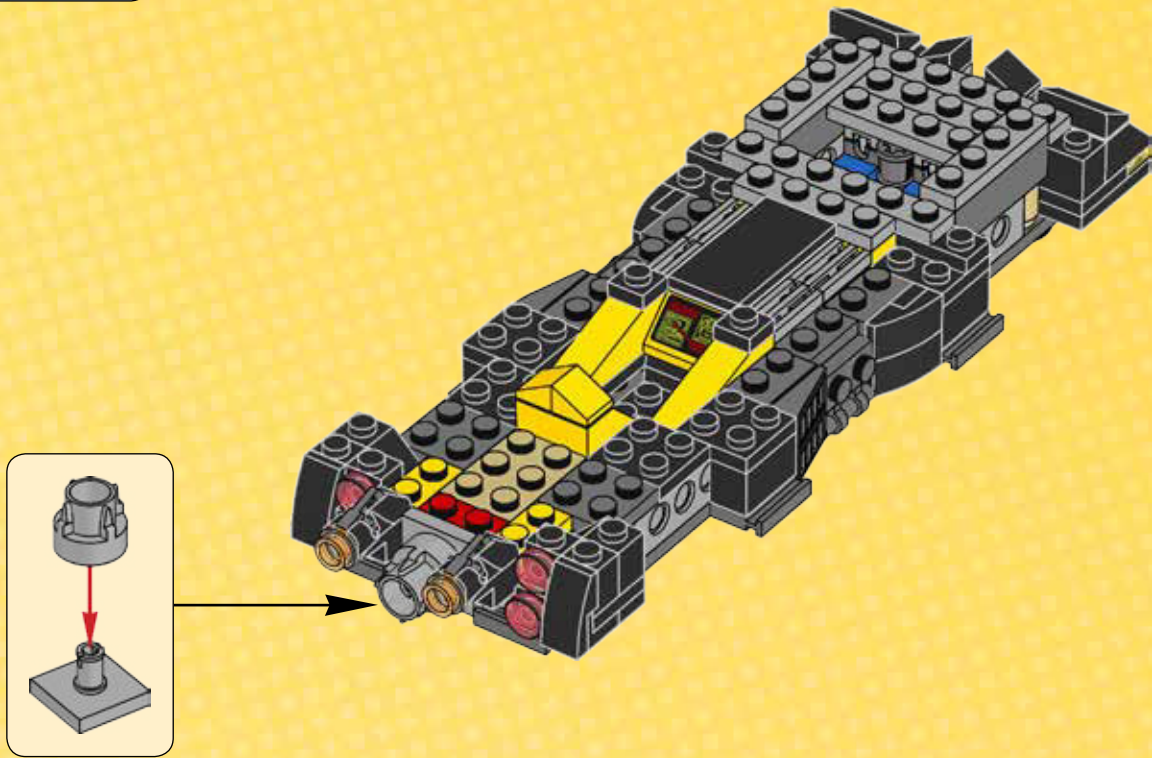



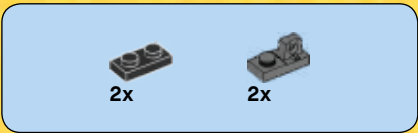

42

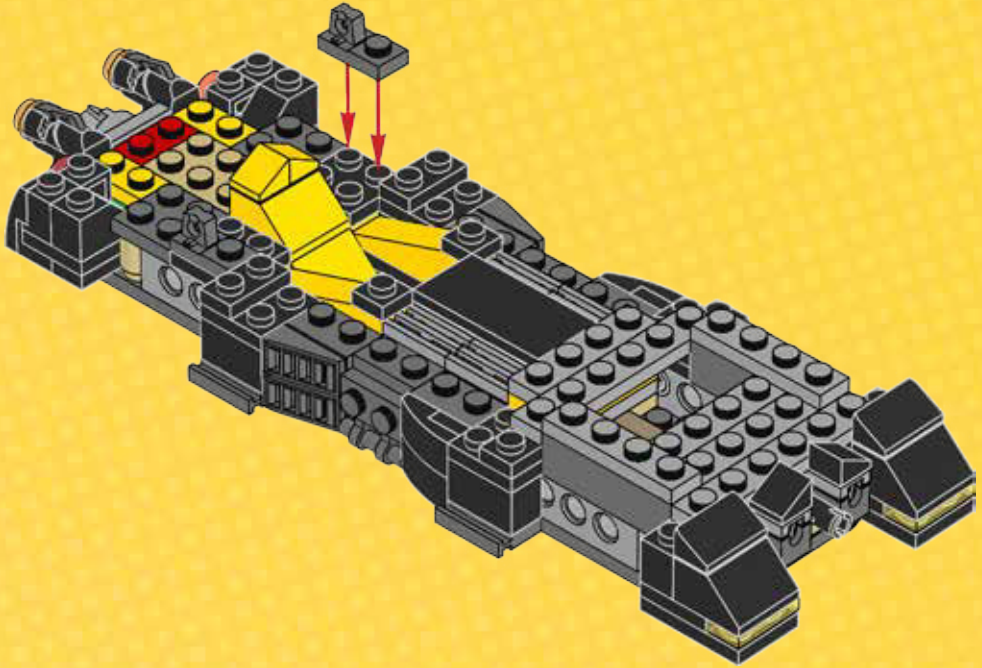



2x



2x

# 43

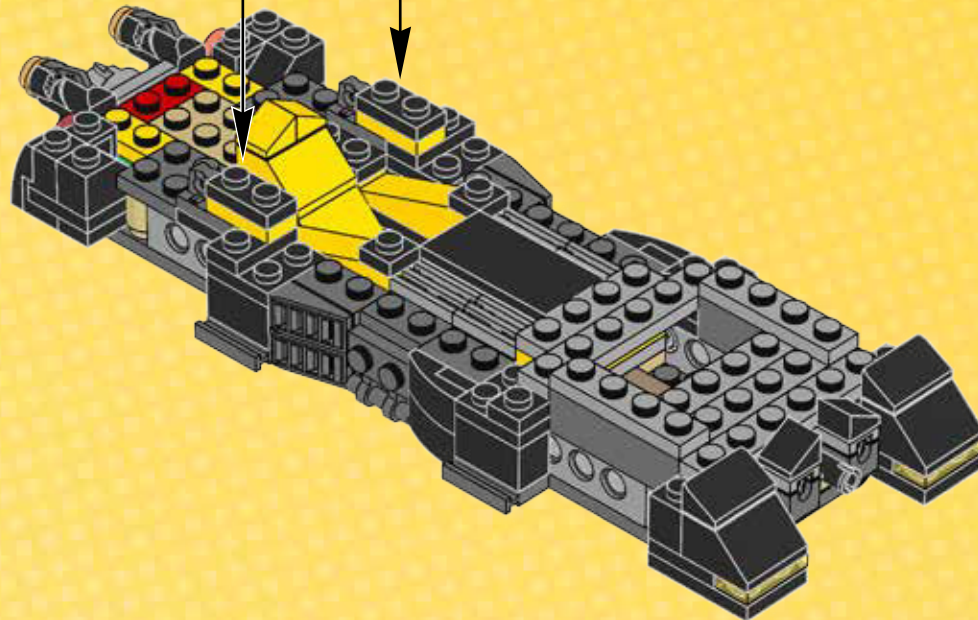
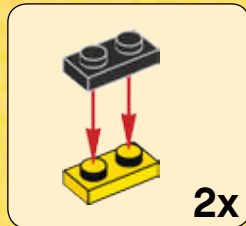

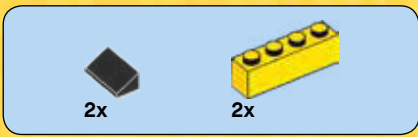

44

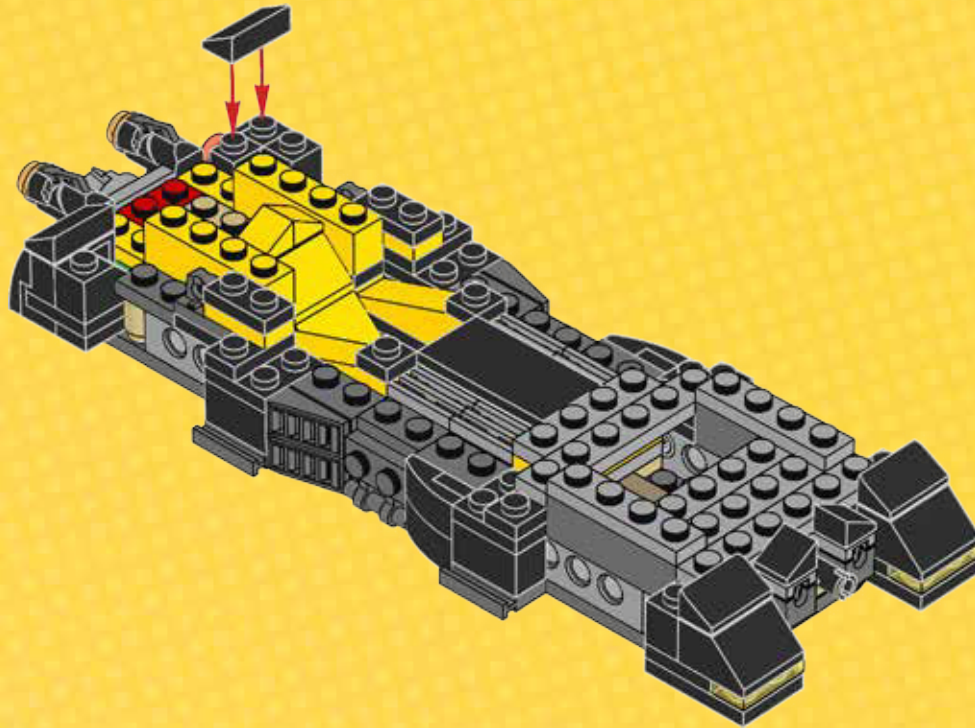

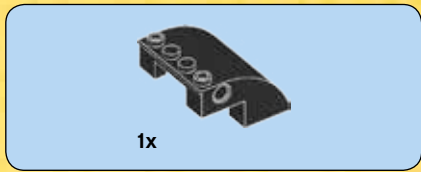

45

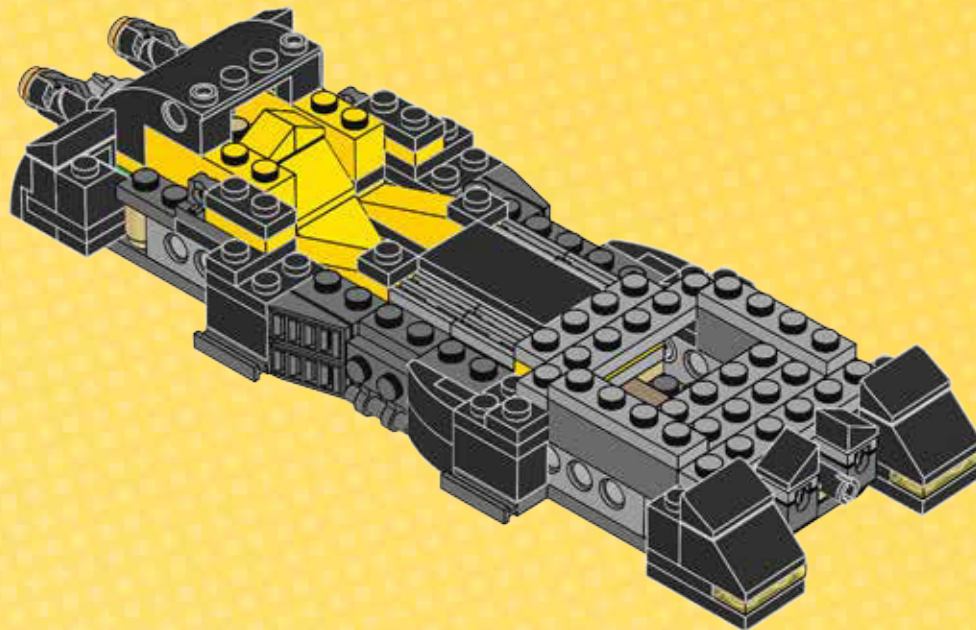



46

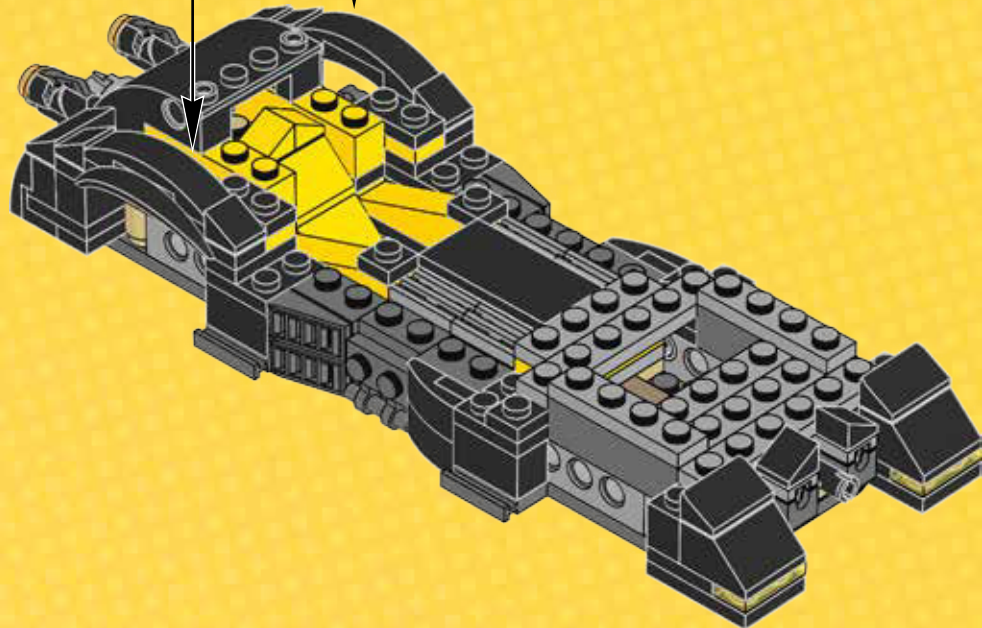
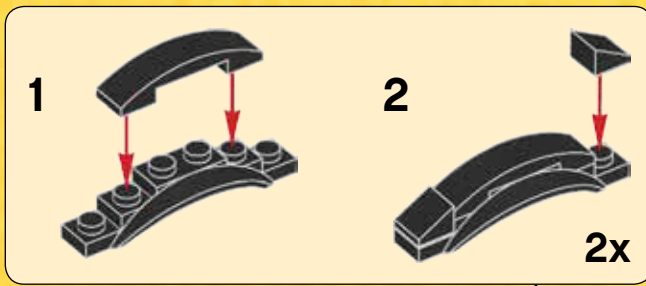

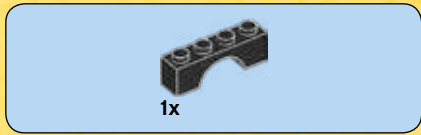

47

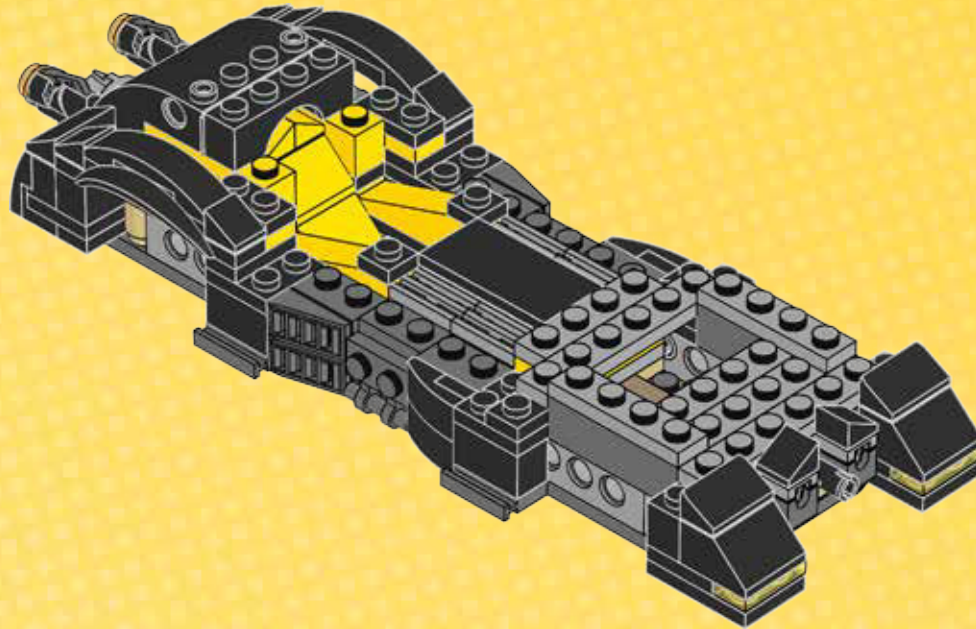



2x

# 48

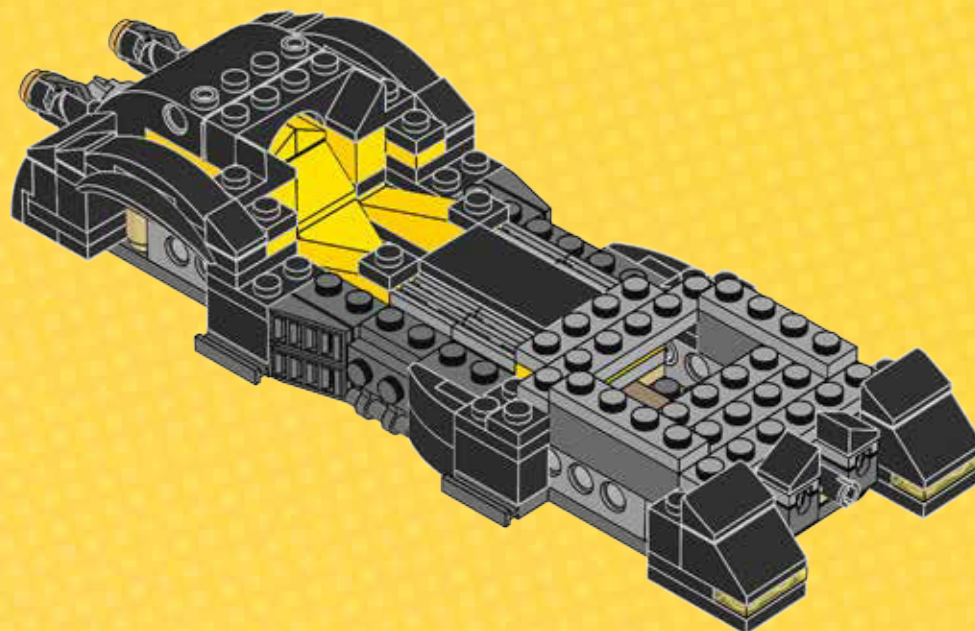

2x

49

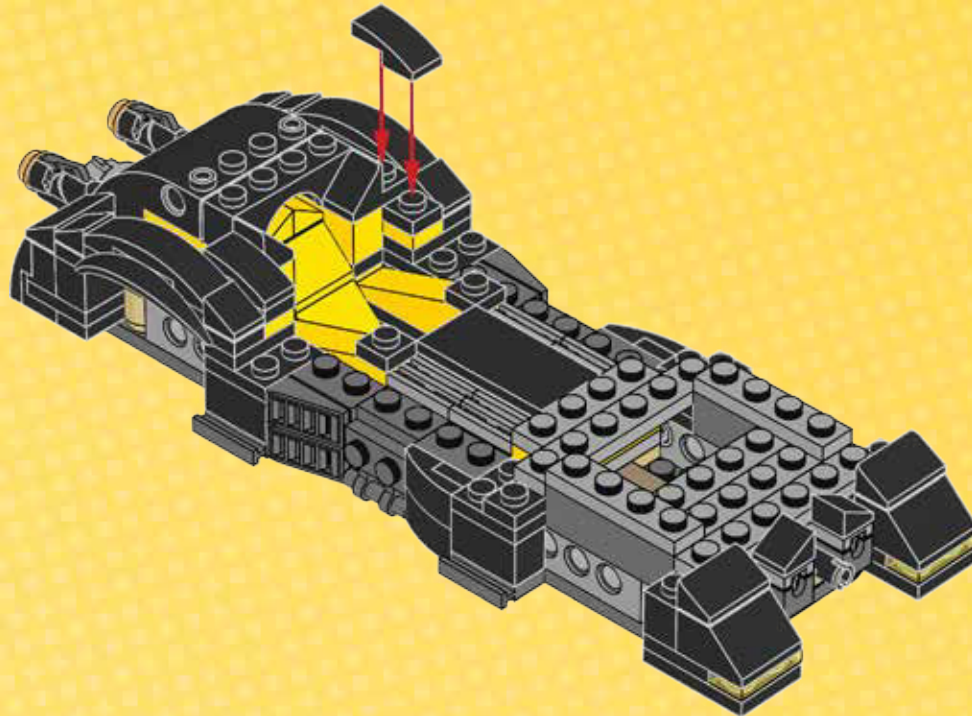





# 50

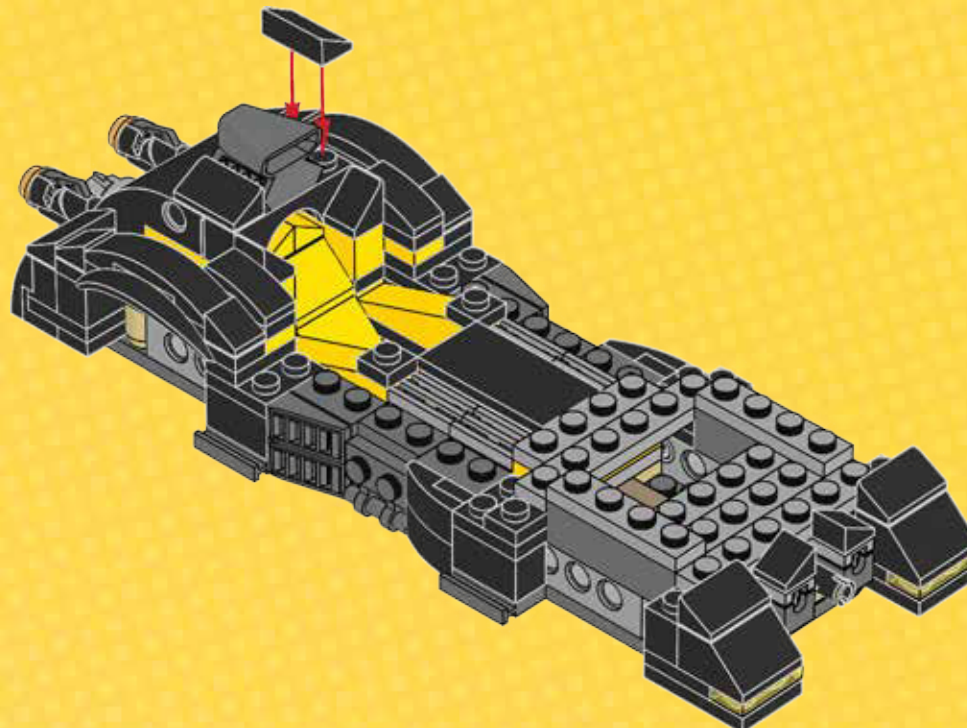



2x



2x

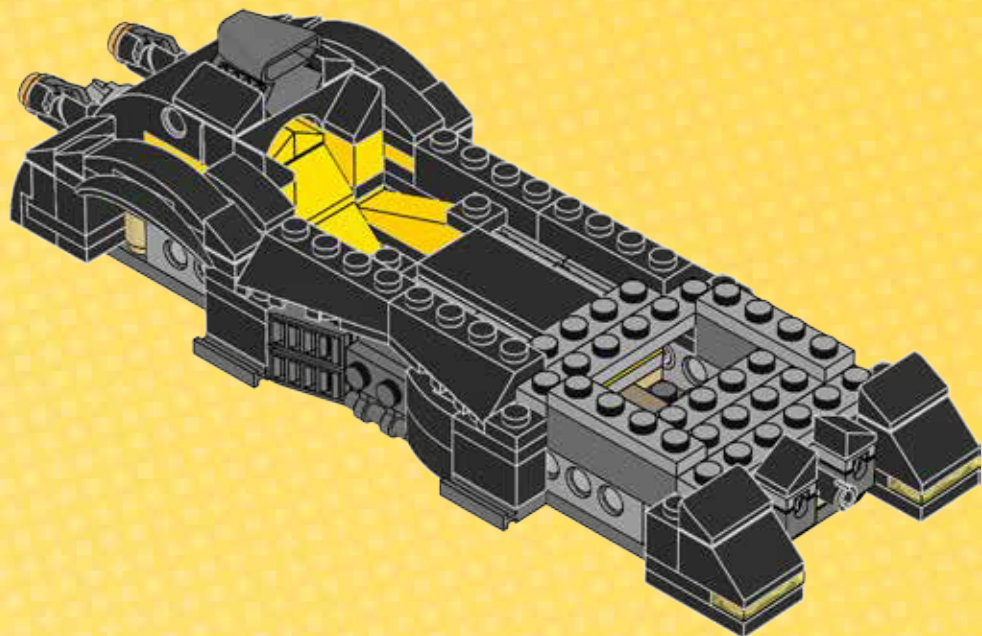

# 51



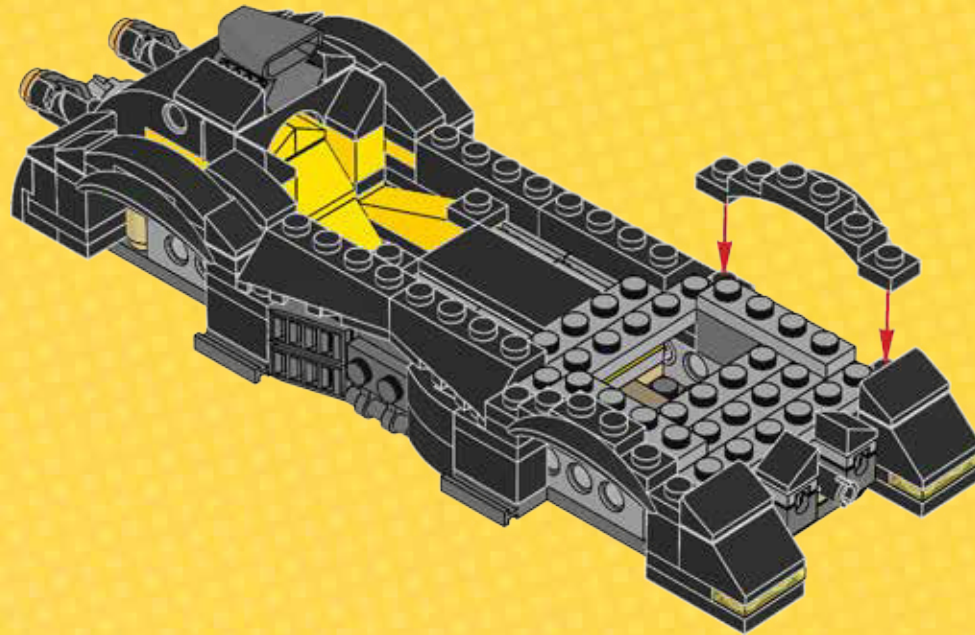

52



2x  1x 

# 53

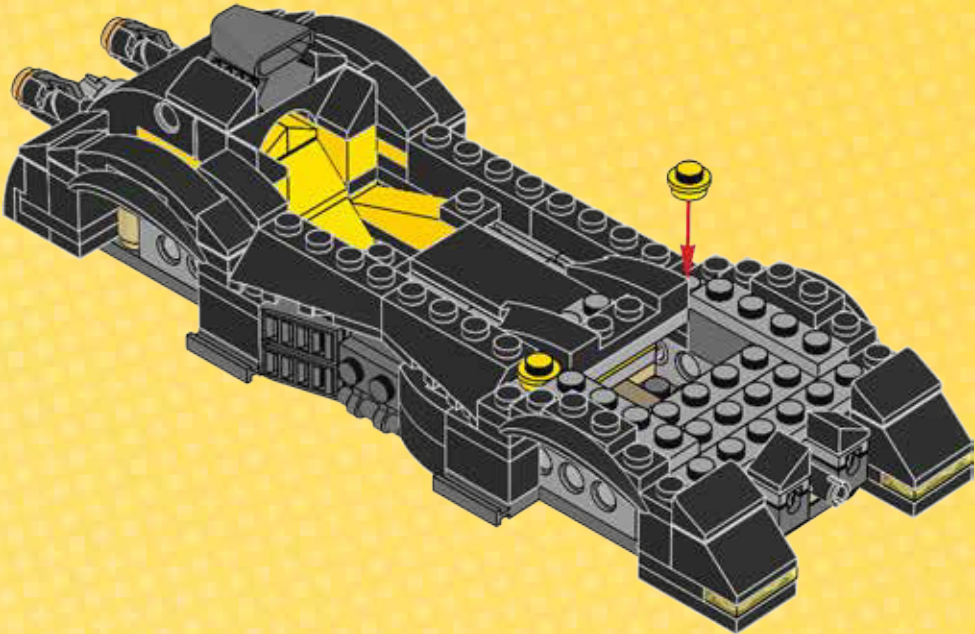



2x

# 54

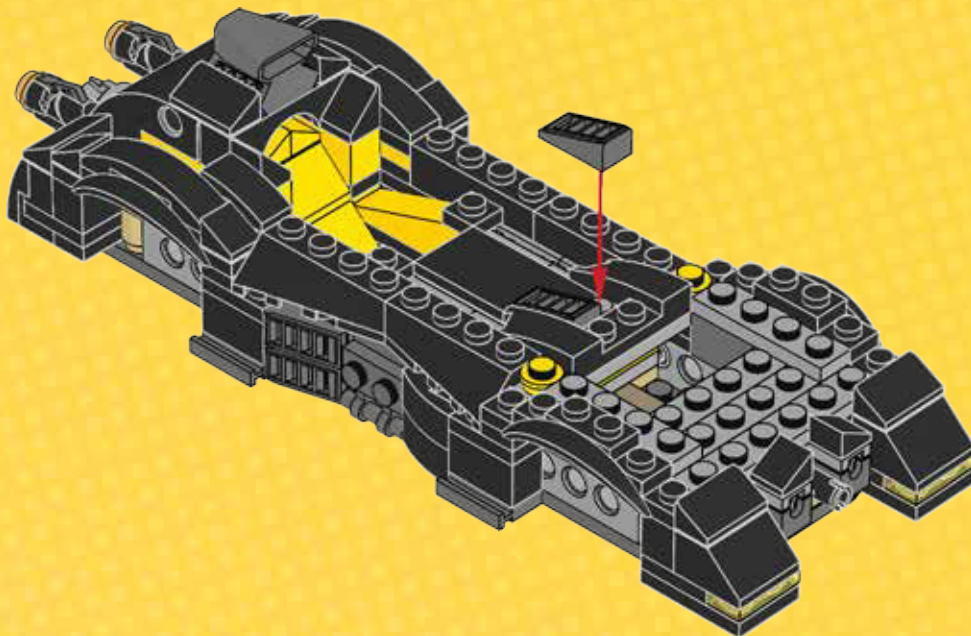



2x



1x

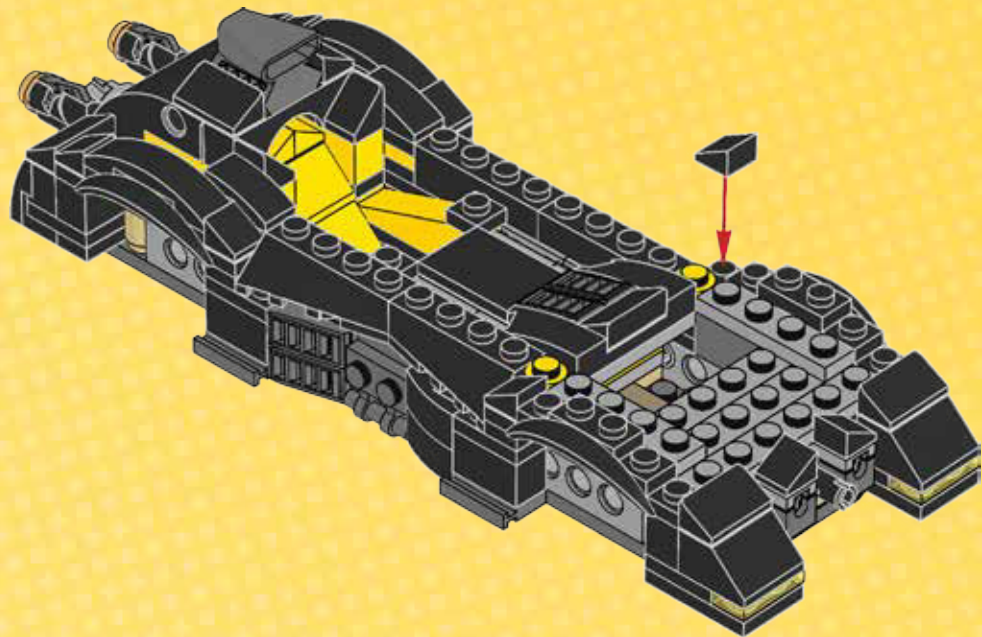

# 55



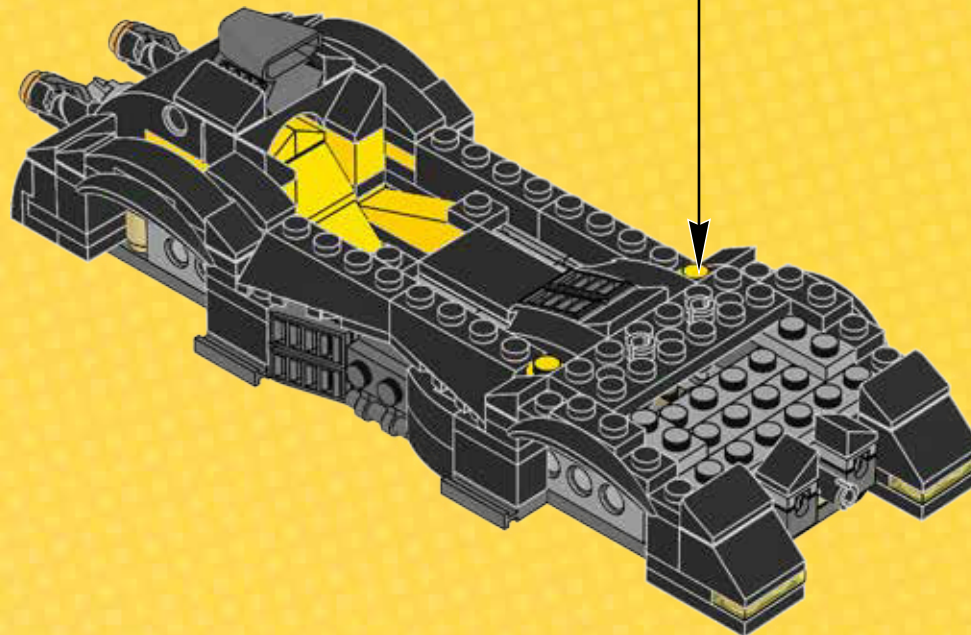
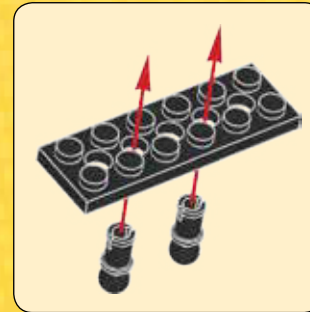

# 56



2x  1x 

# 57

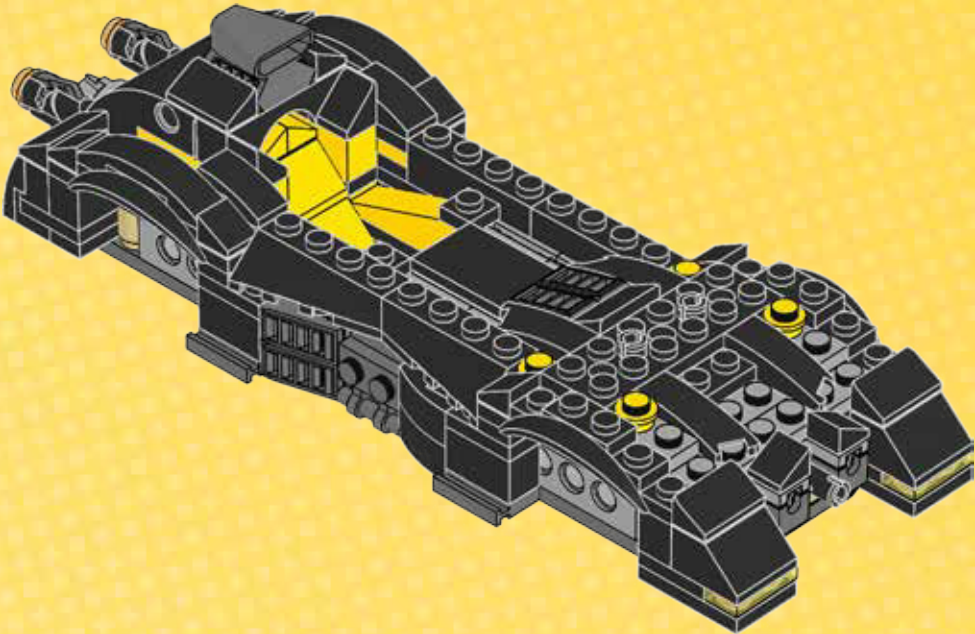





58

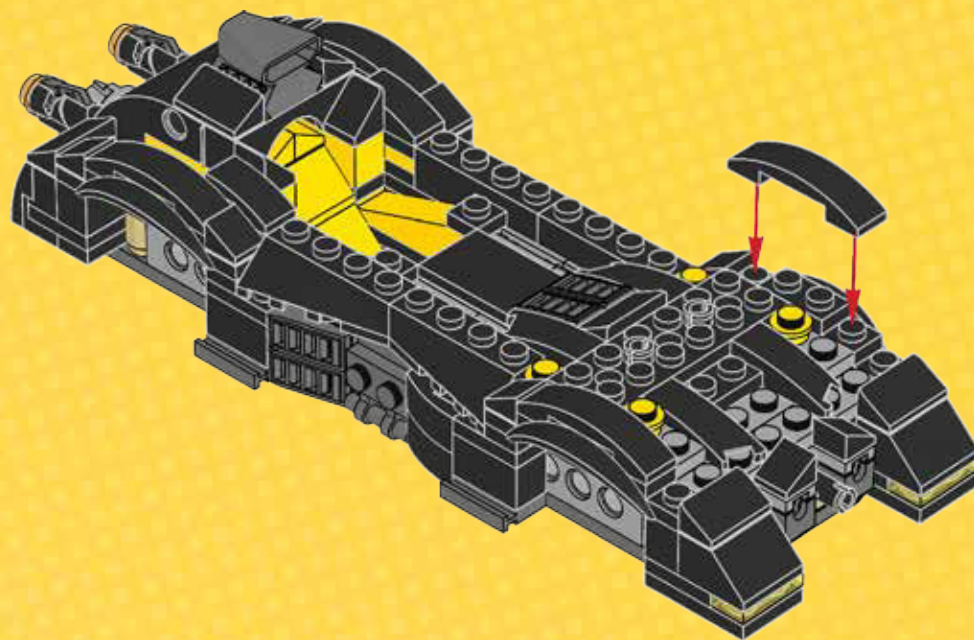



3x

# 59

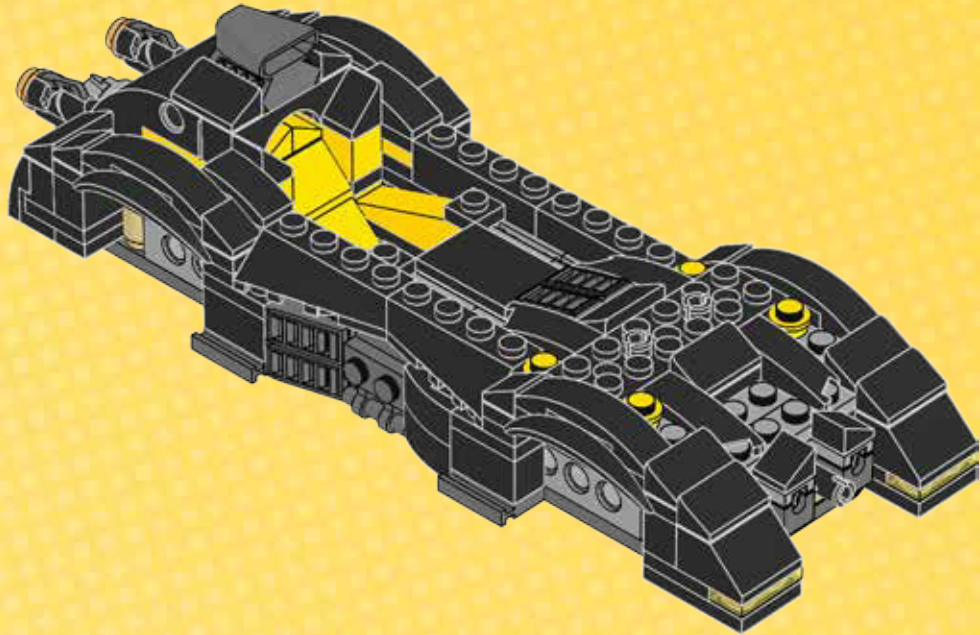



2x



2x

# 60

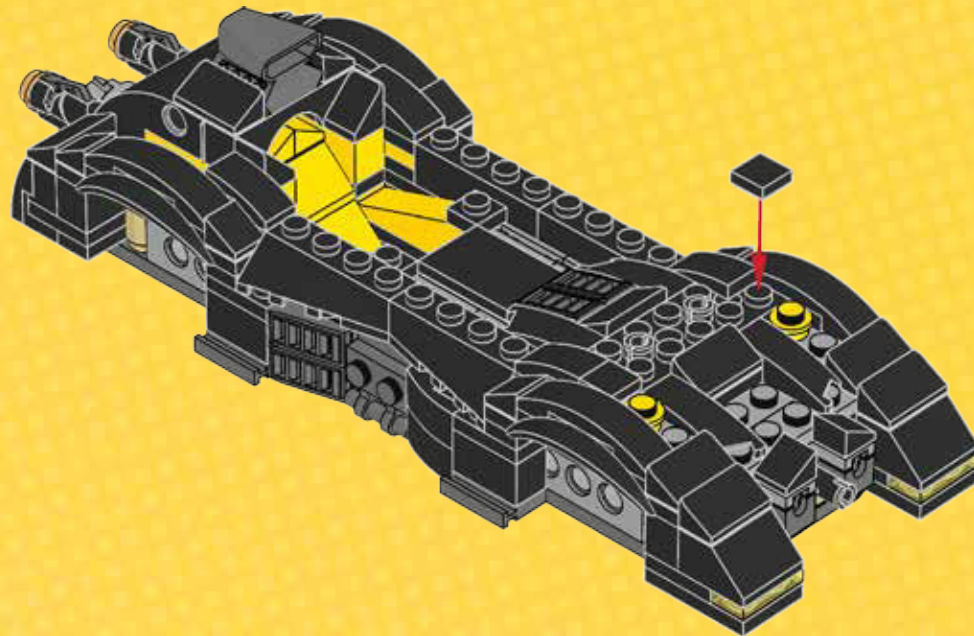

2x

2x

# 61

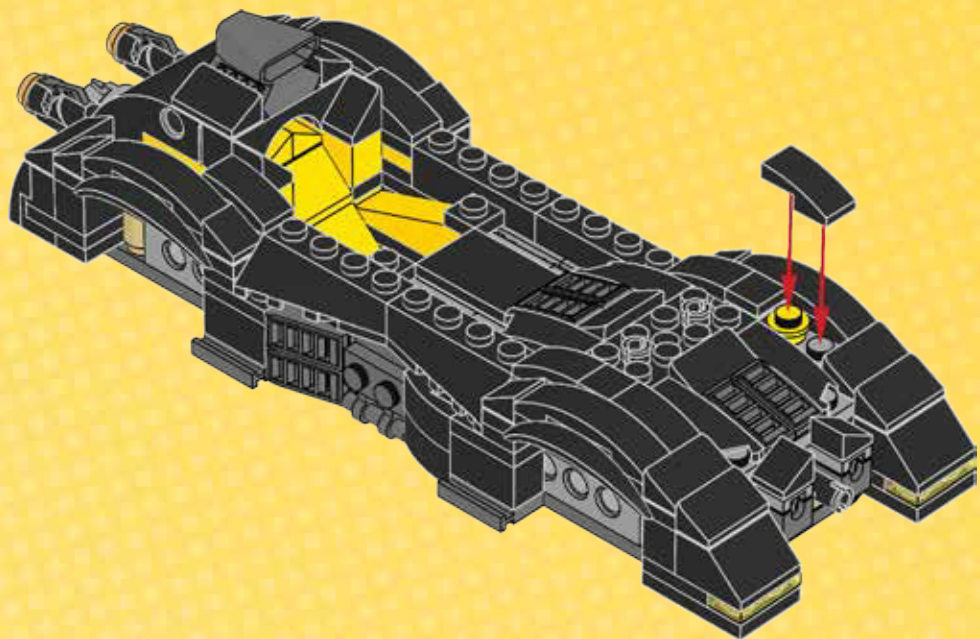



62

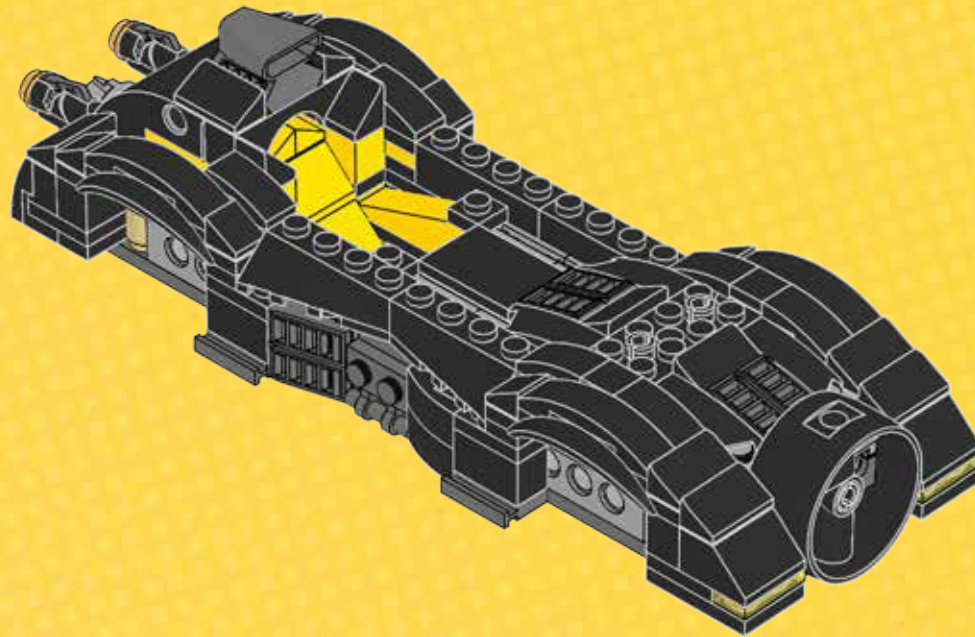

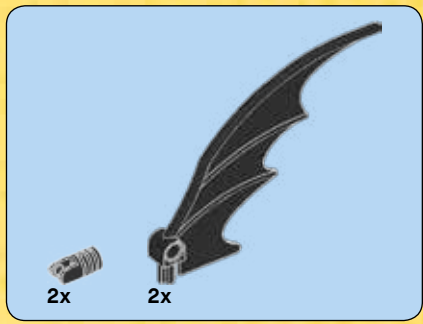

63

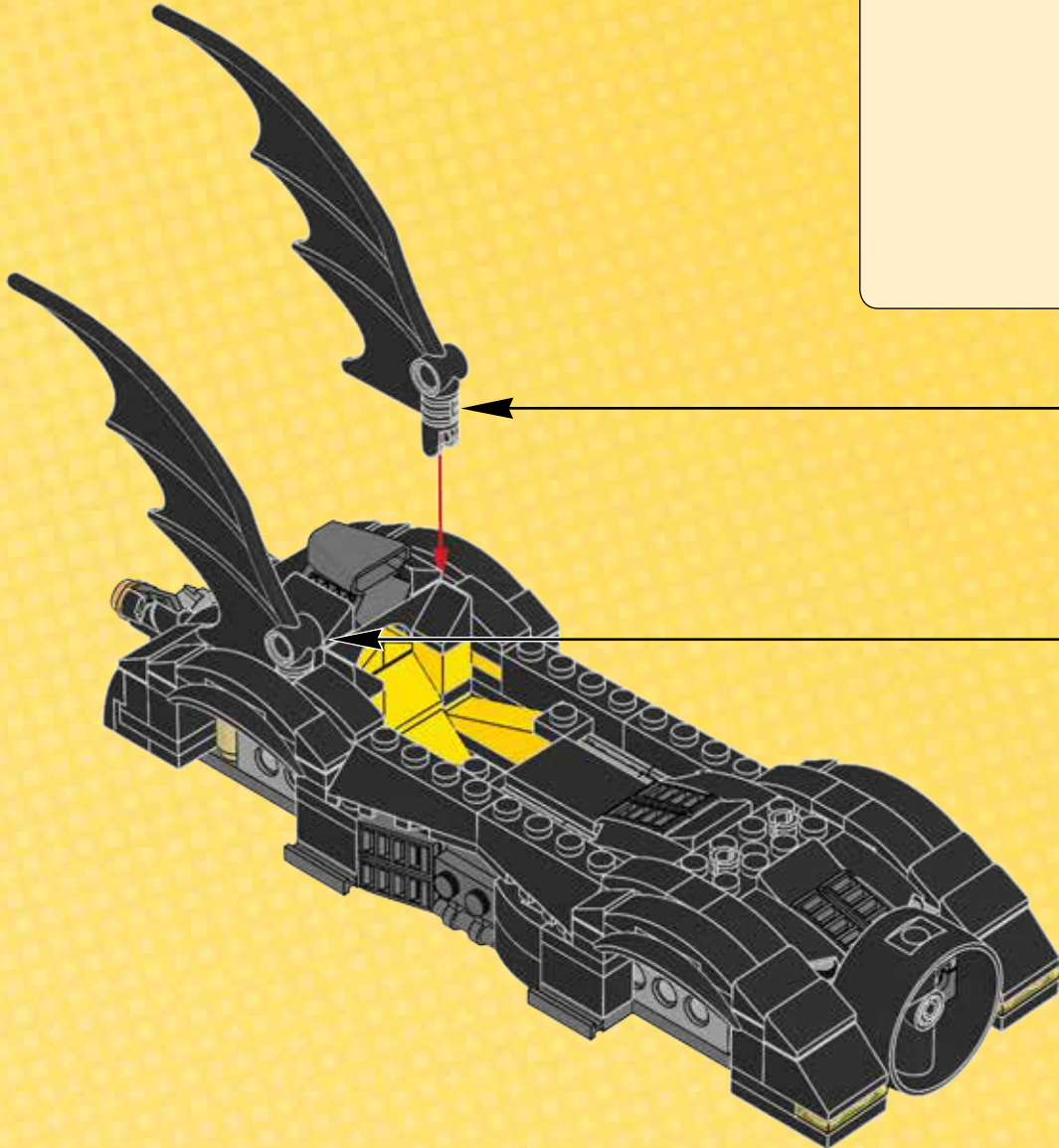
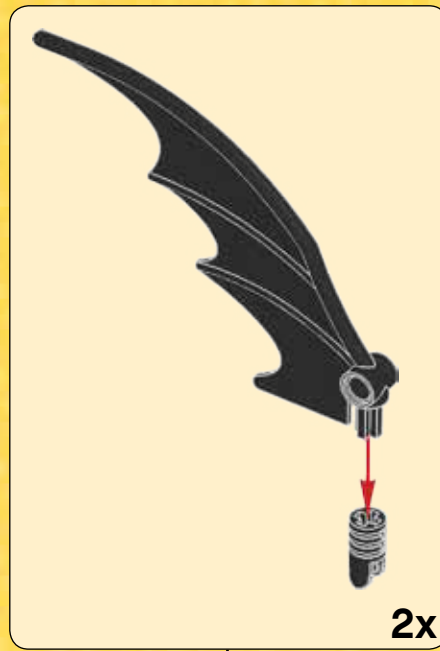

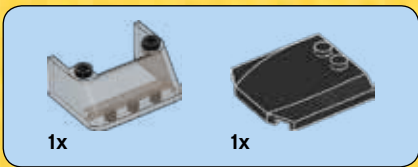

64

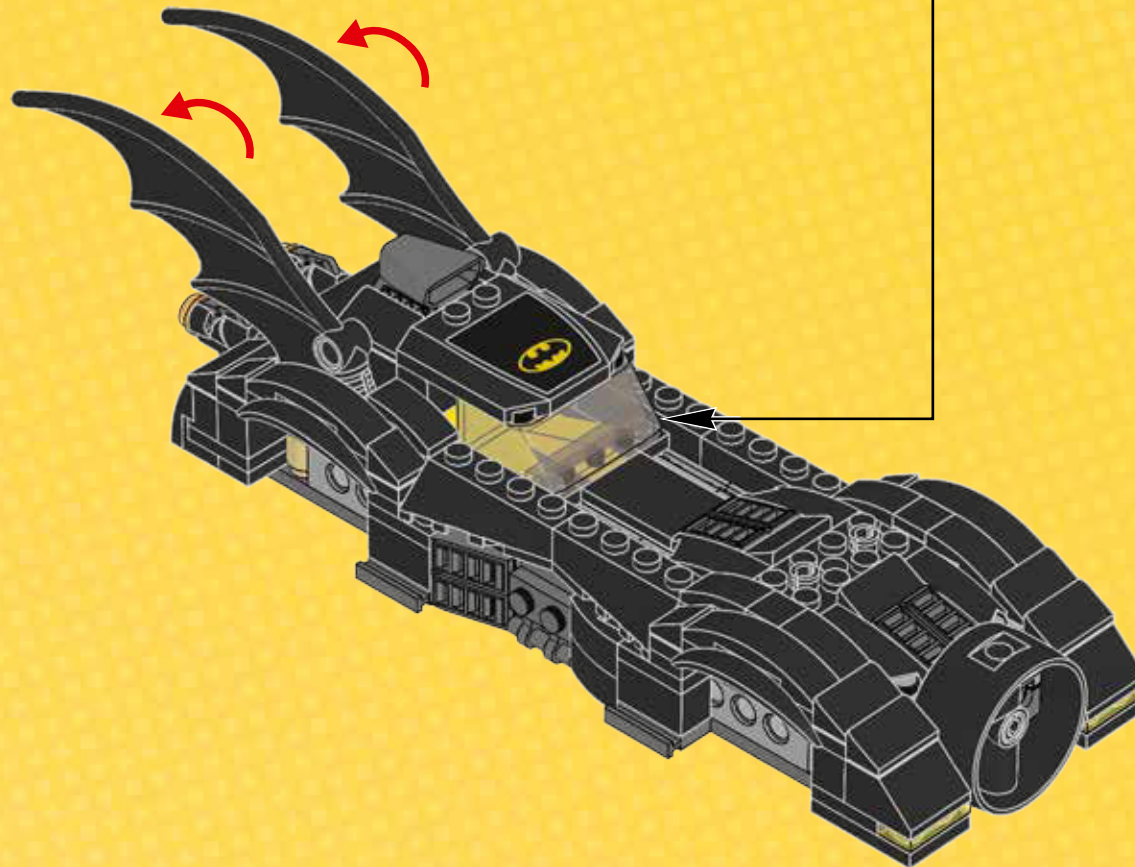
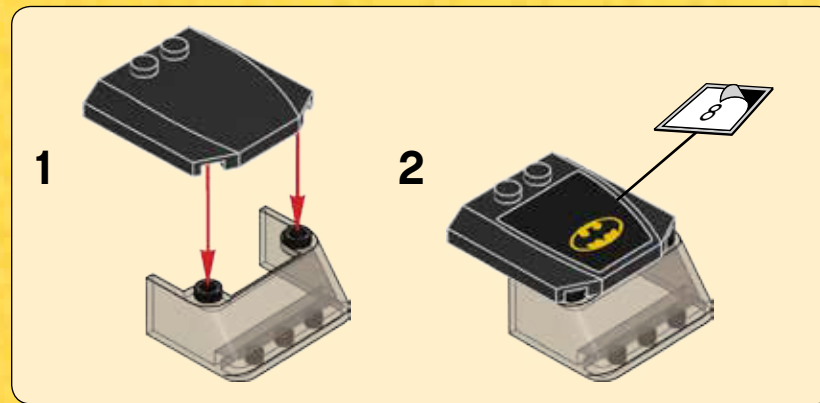

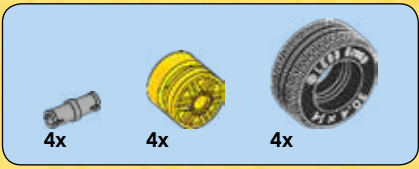

65

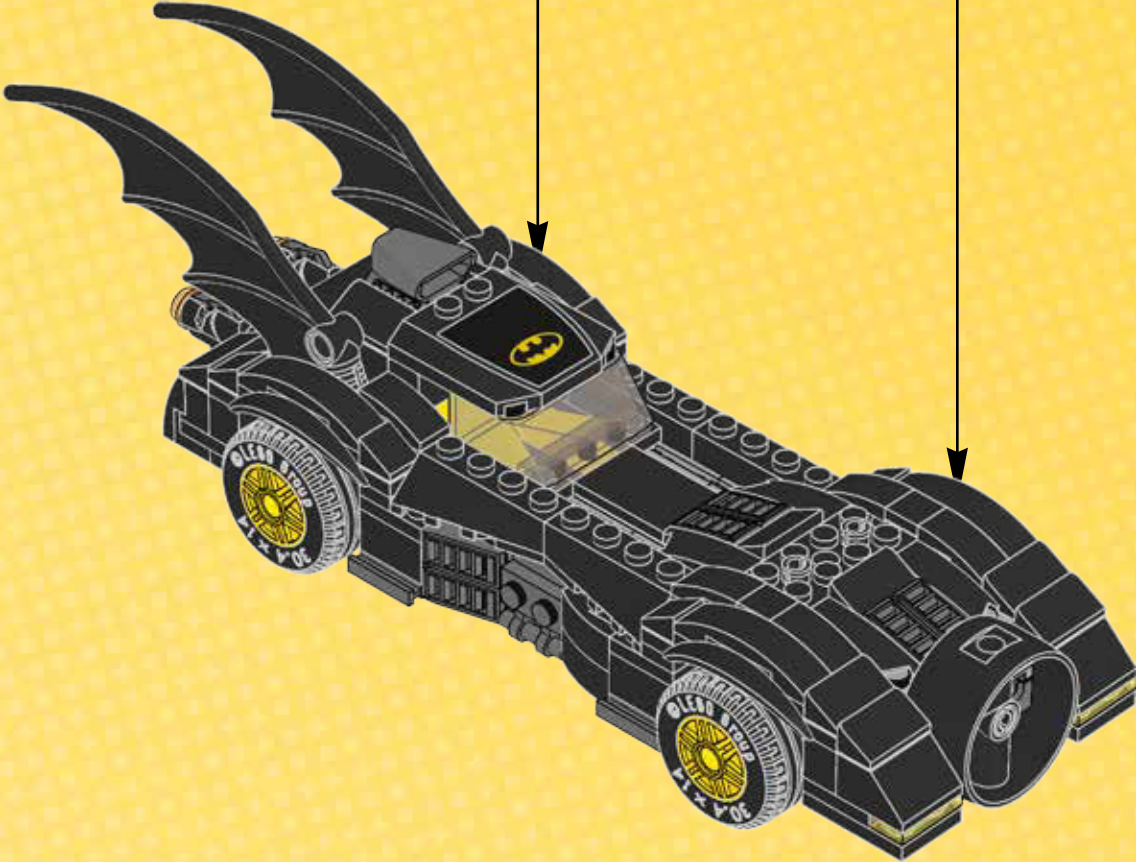
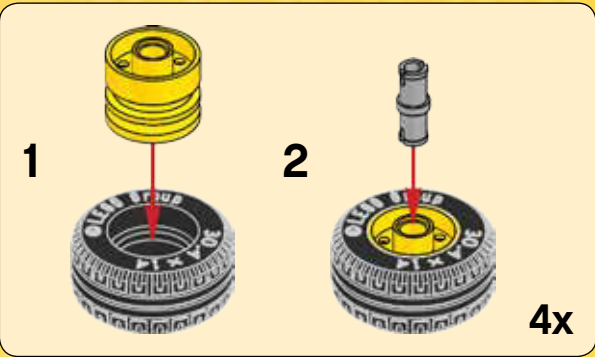





66

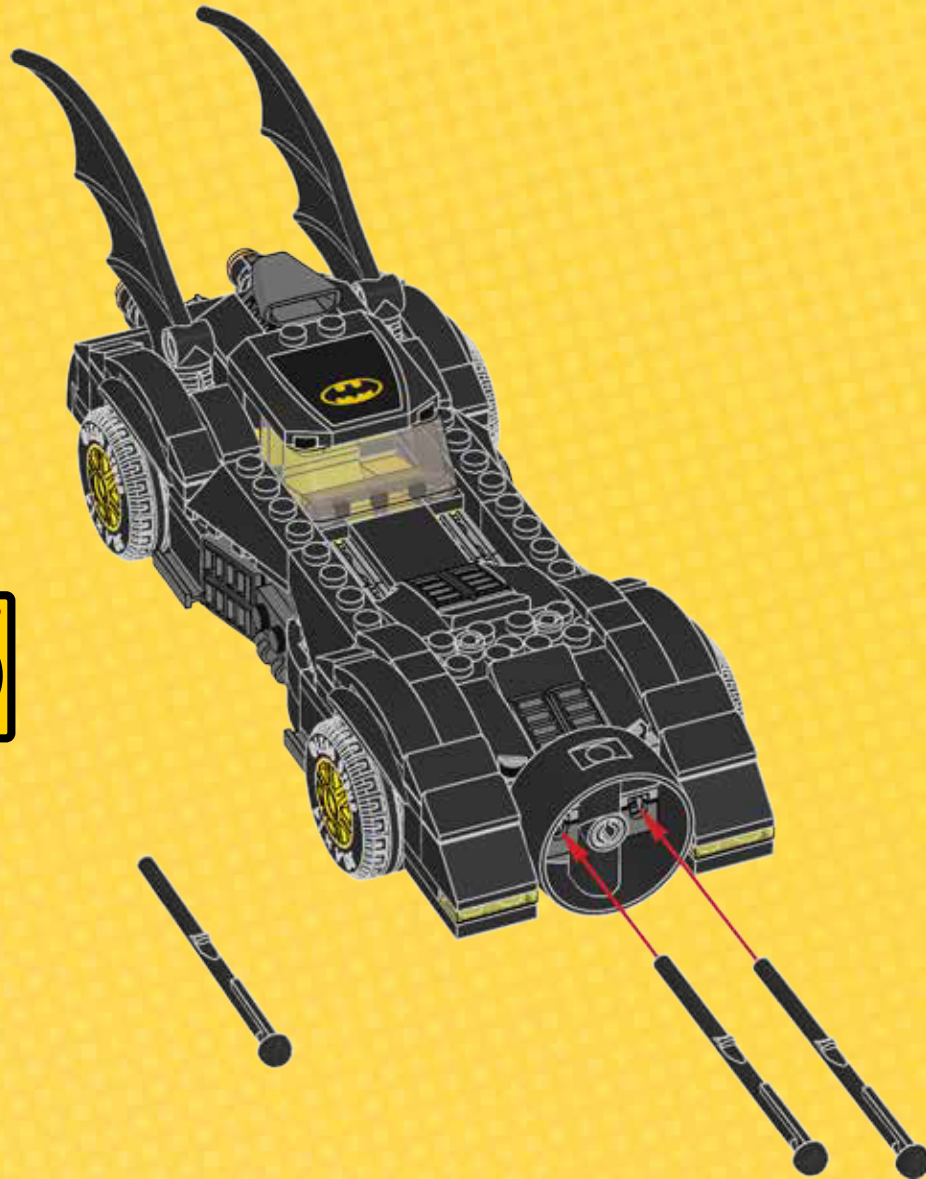



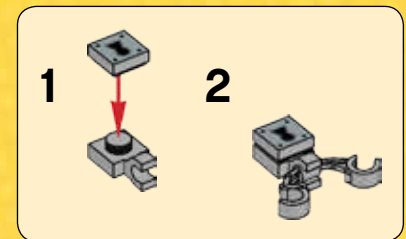
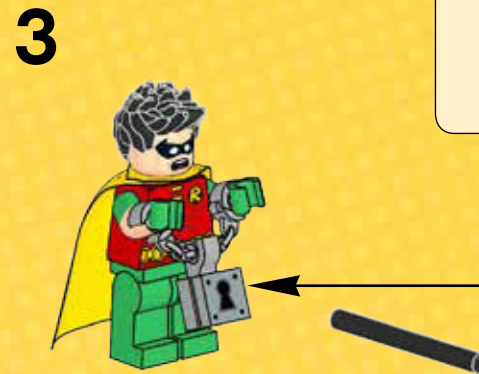
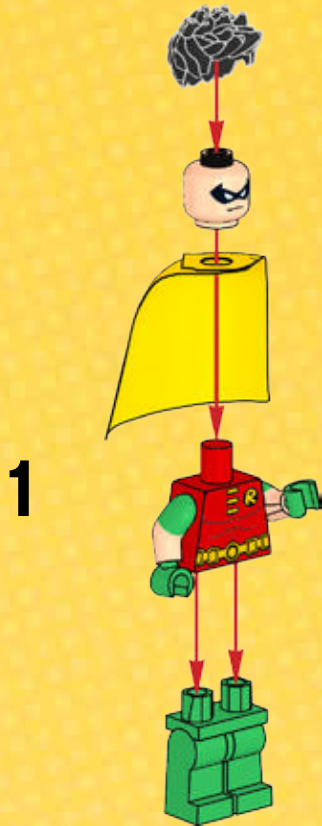
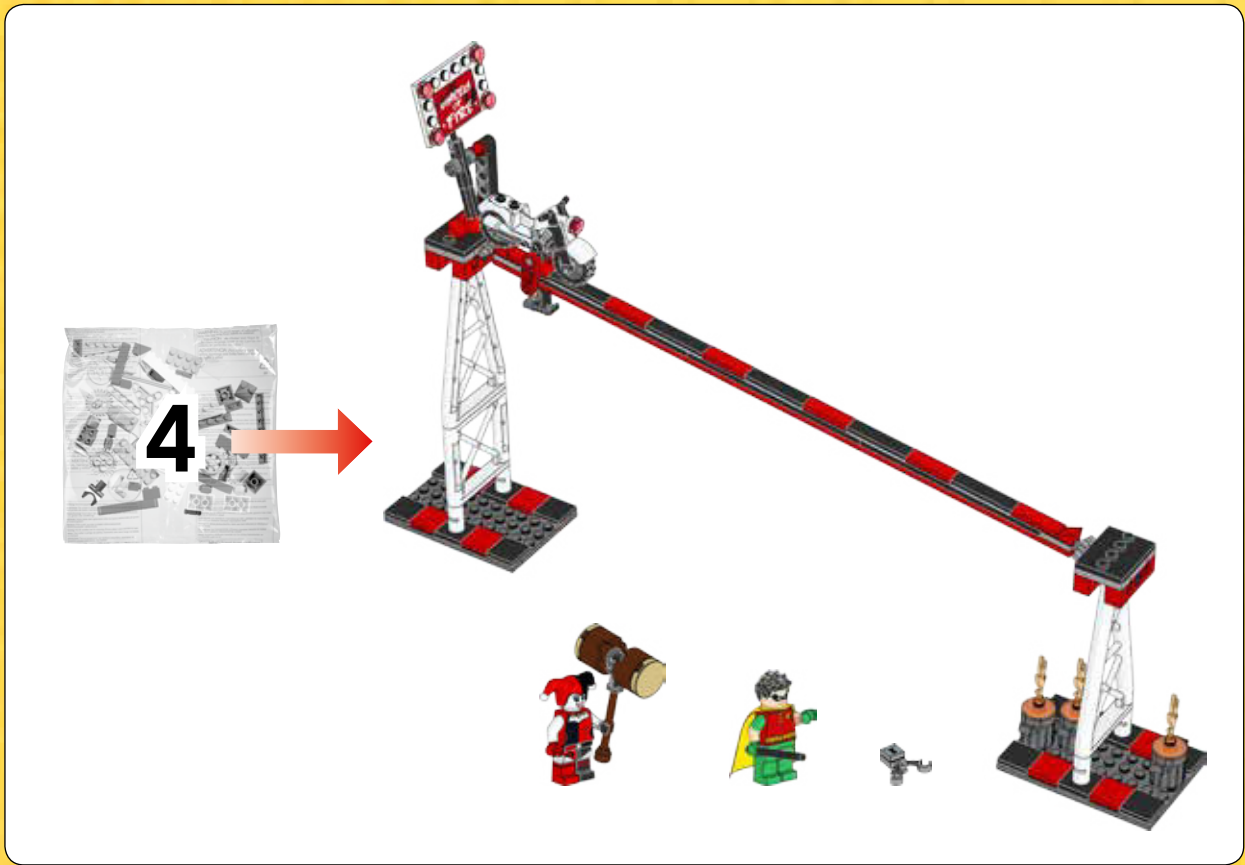

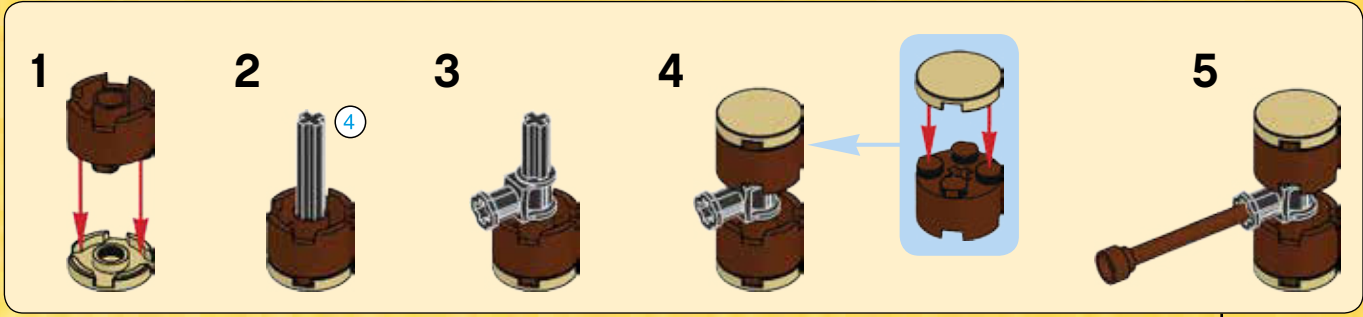

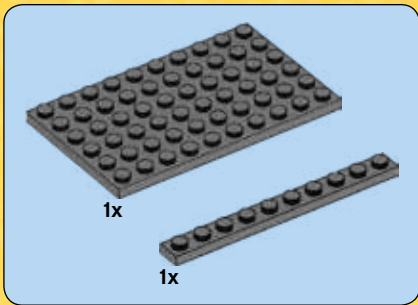
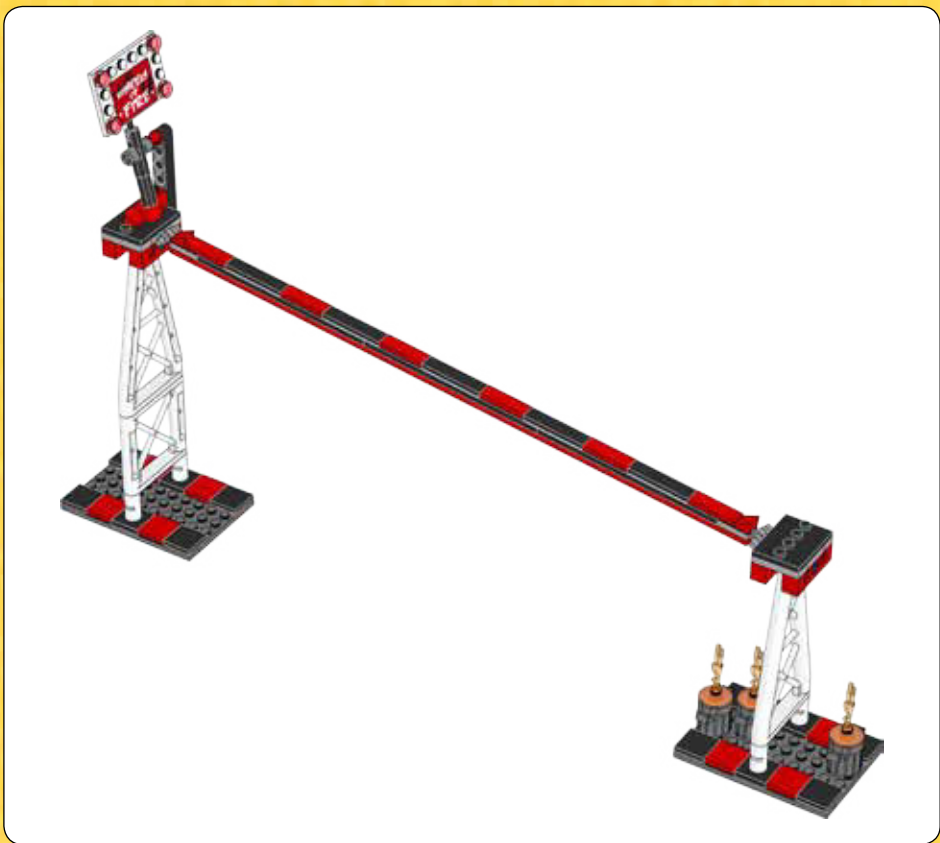

1

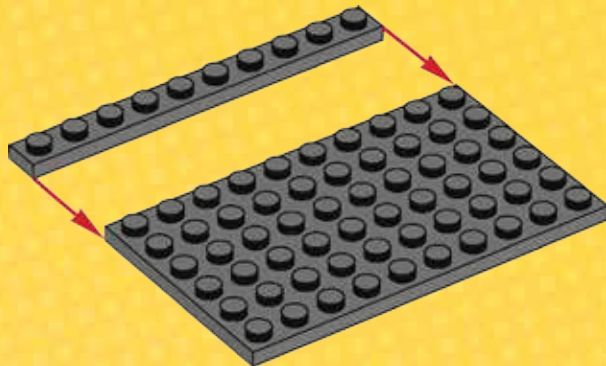



2

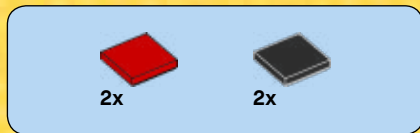
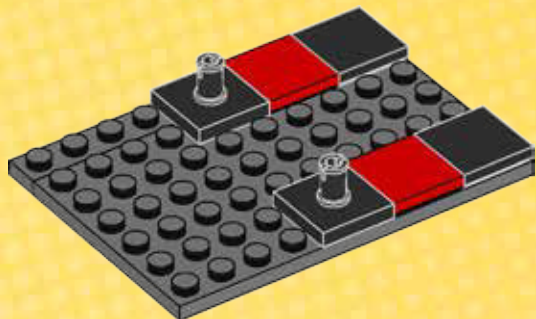

3

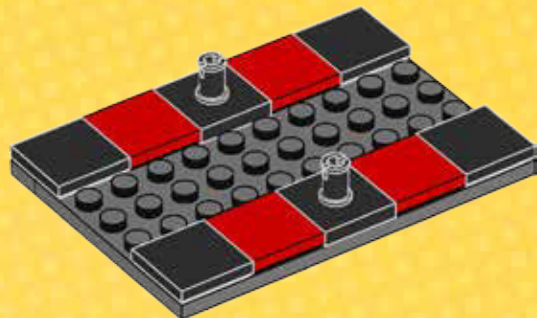

4

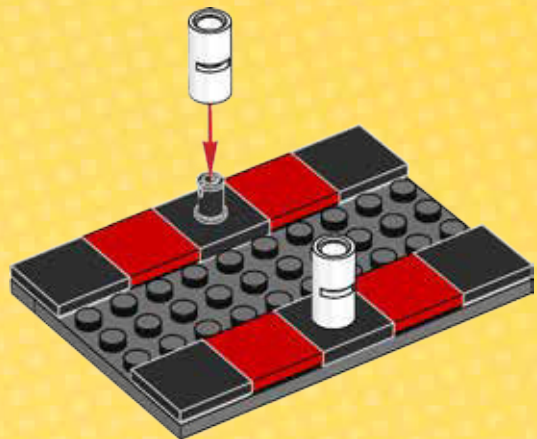

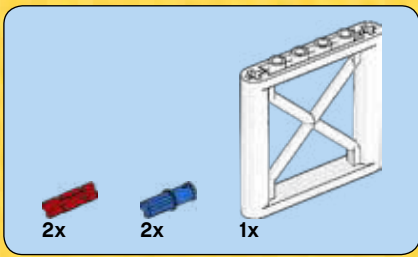

5

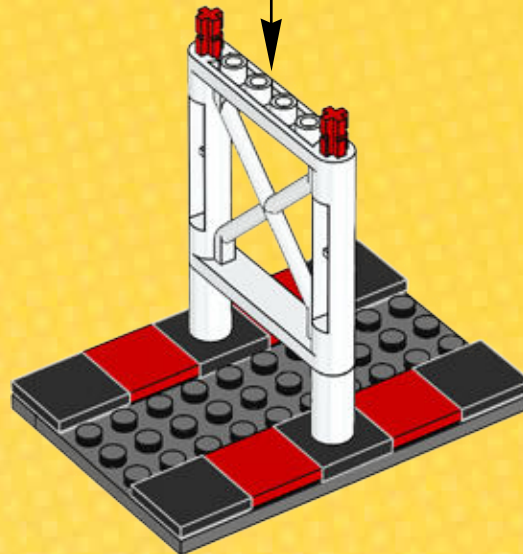
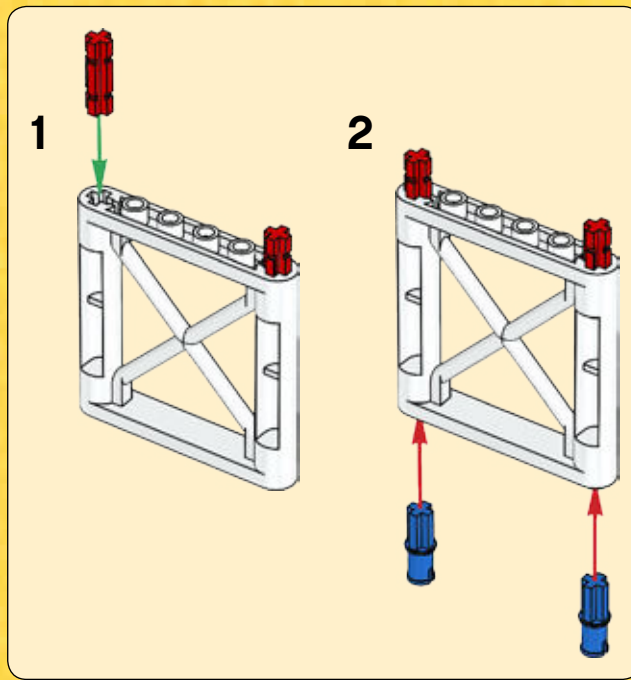

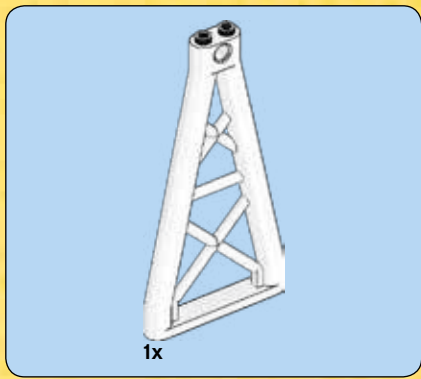

6

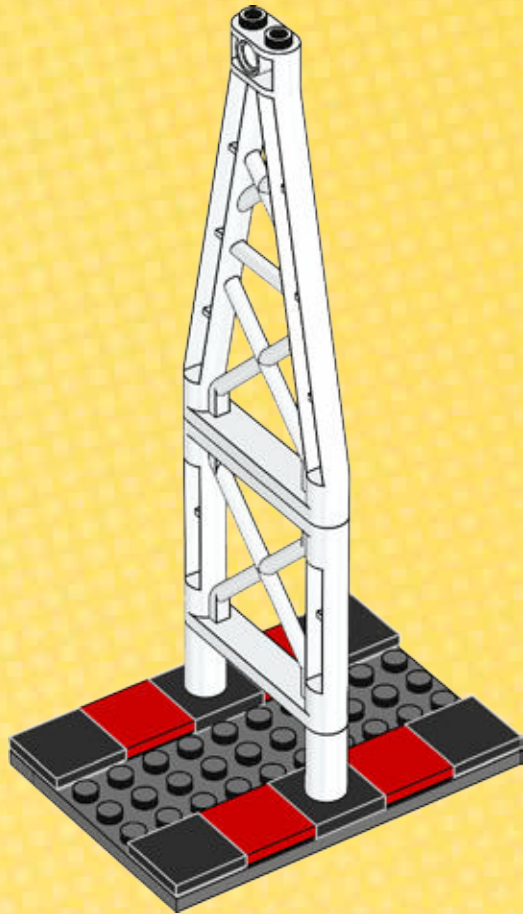

7

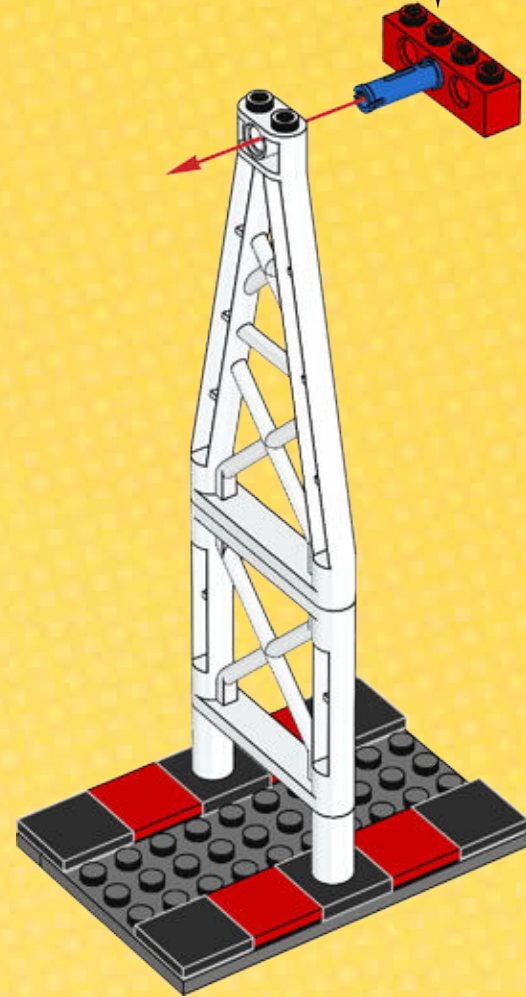
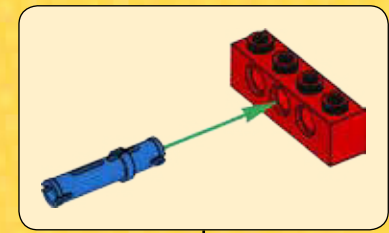



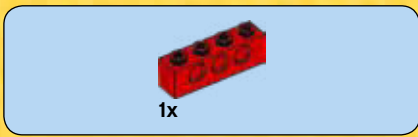

8

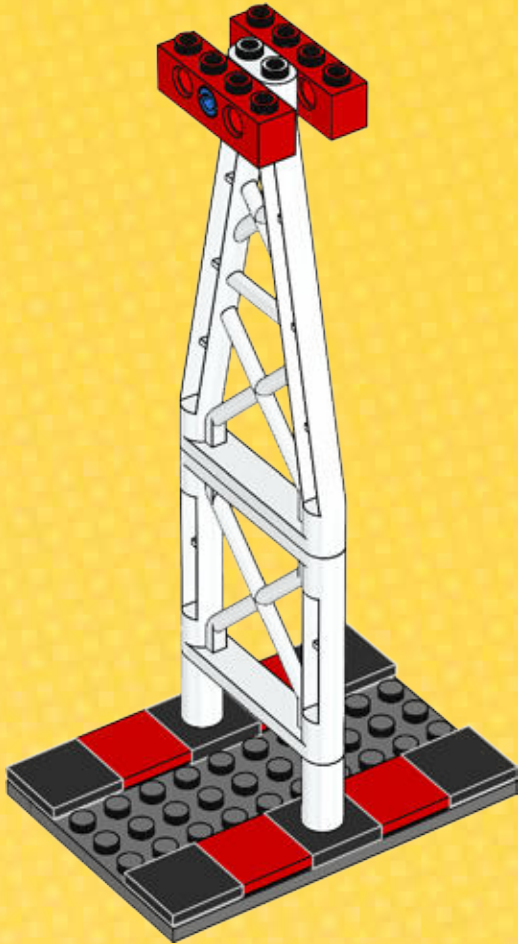

9

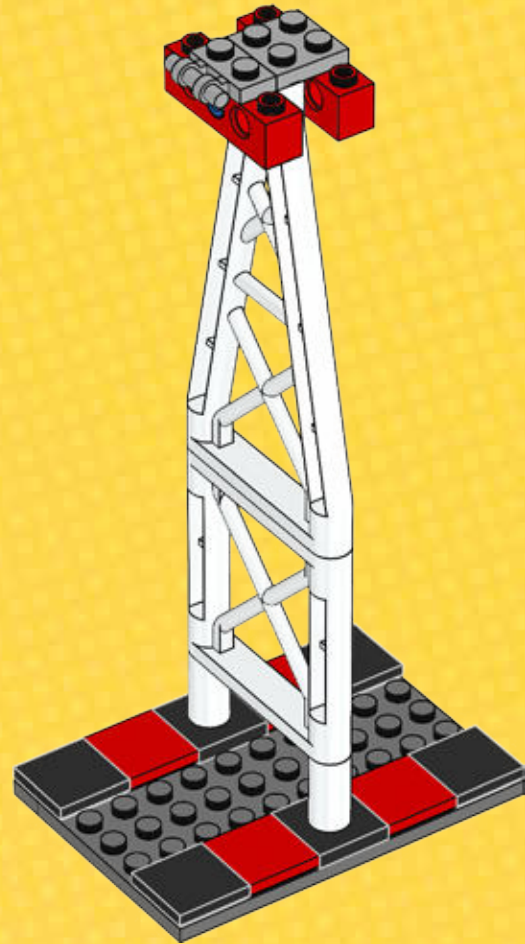



2x

# 10

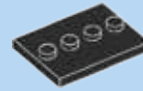
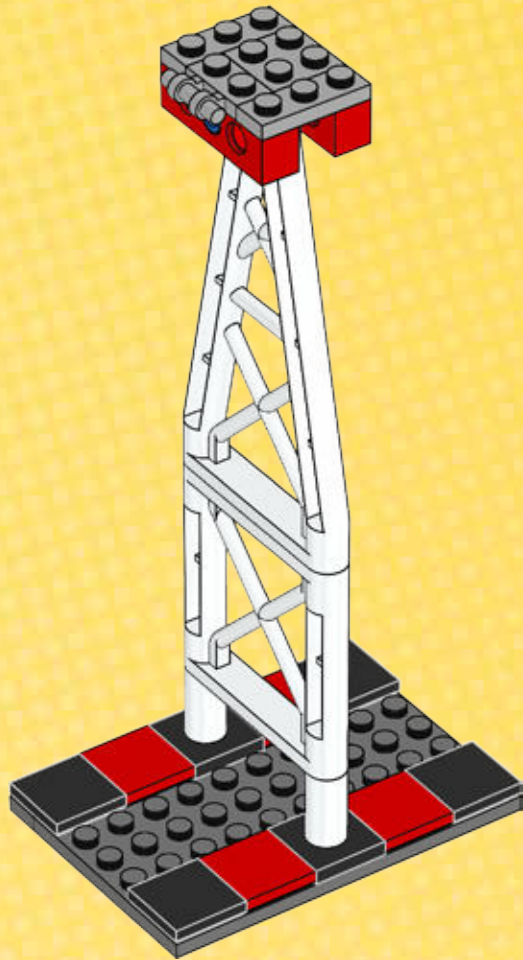

1x

# 11

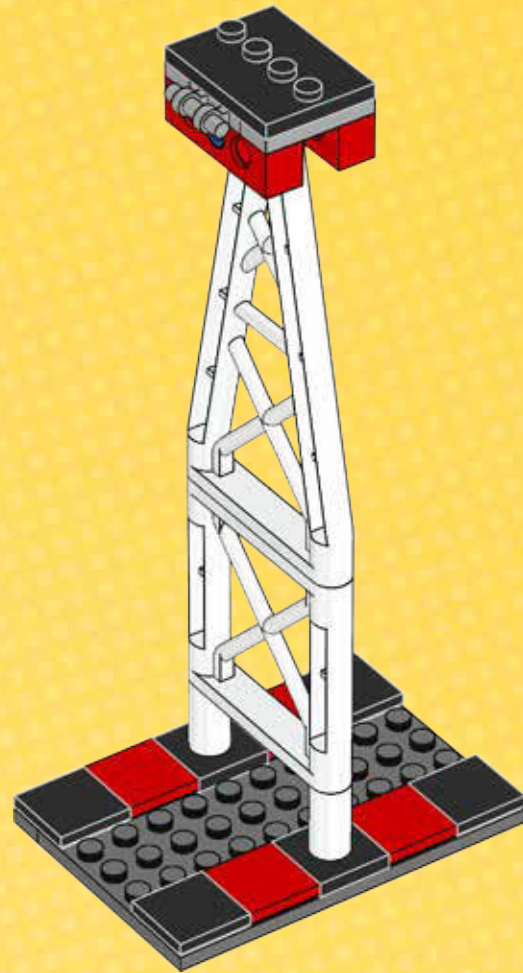



2x

# 12

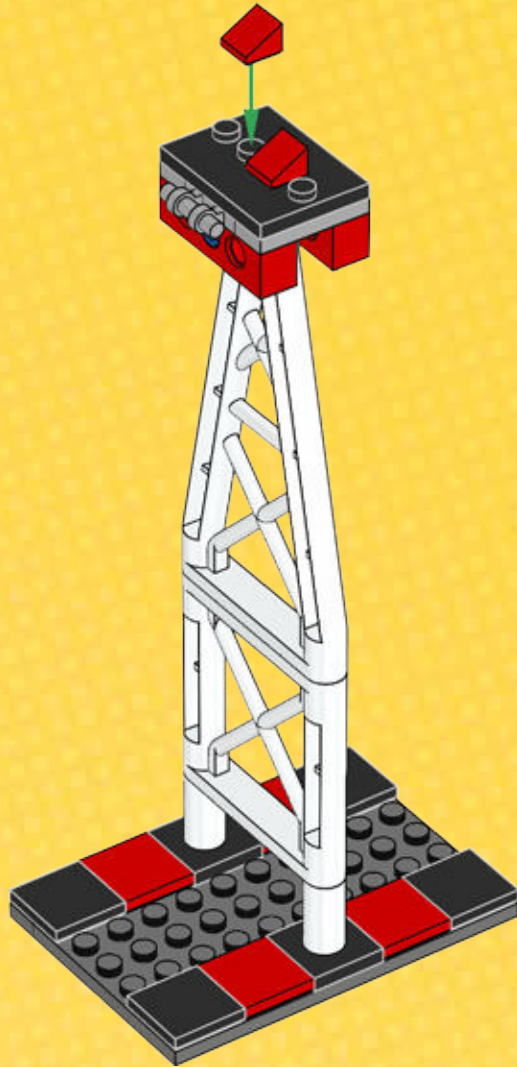

2x



2x

# 13

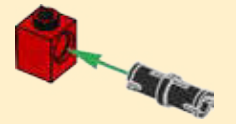

2x

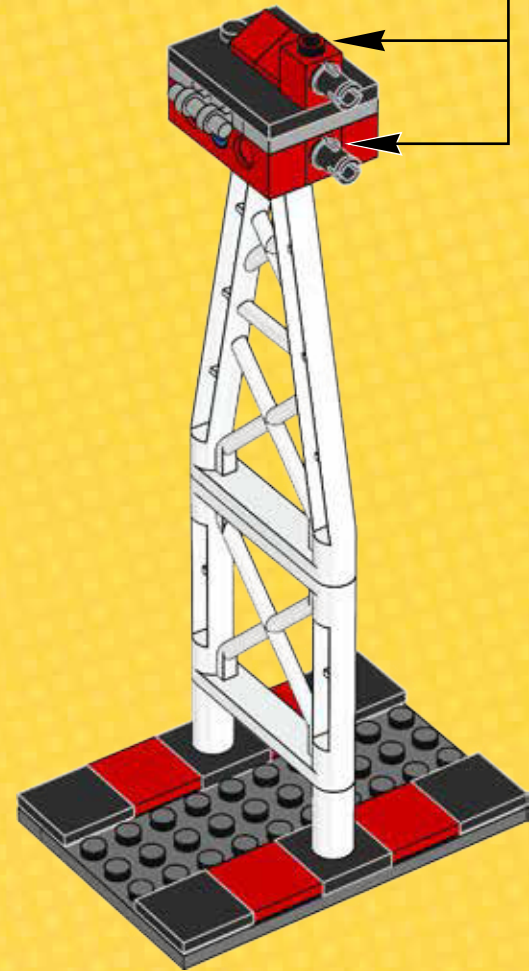

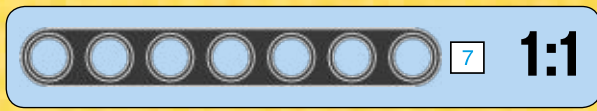
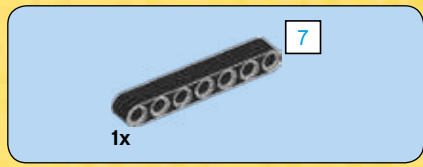

14

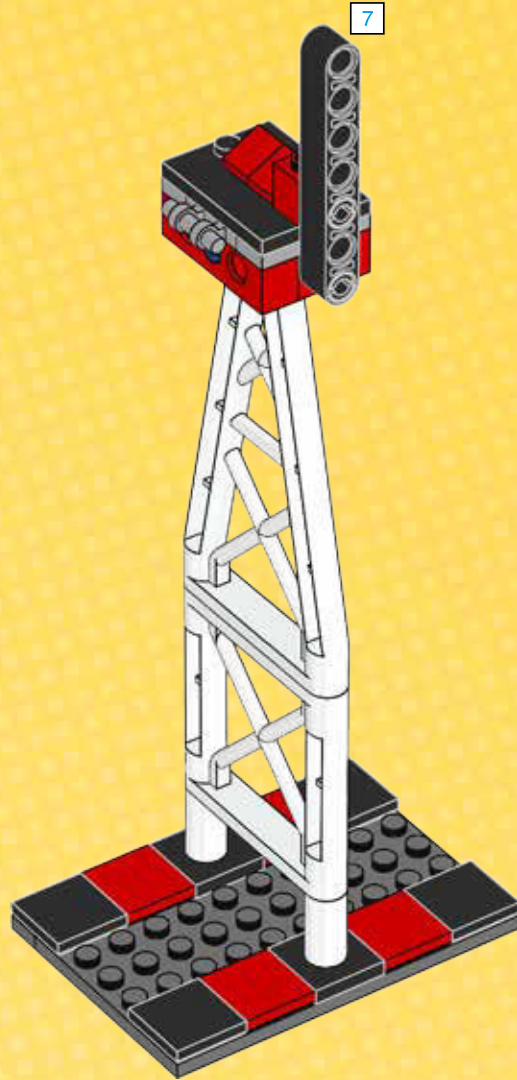

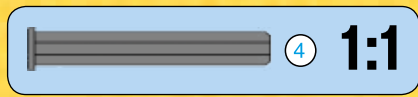
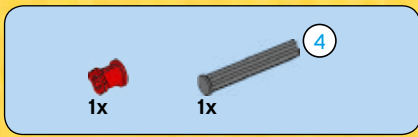

15

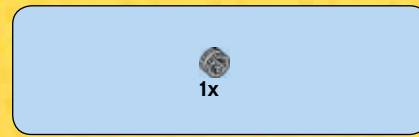
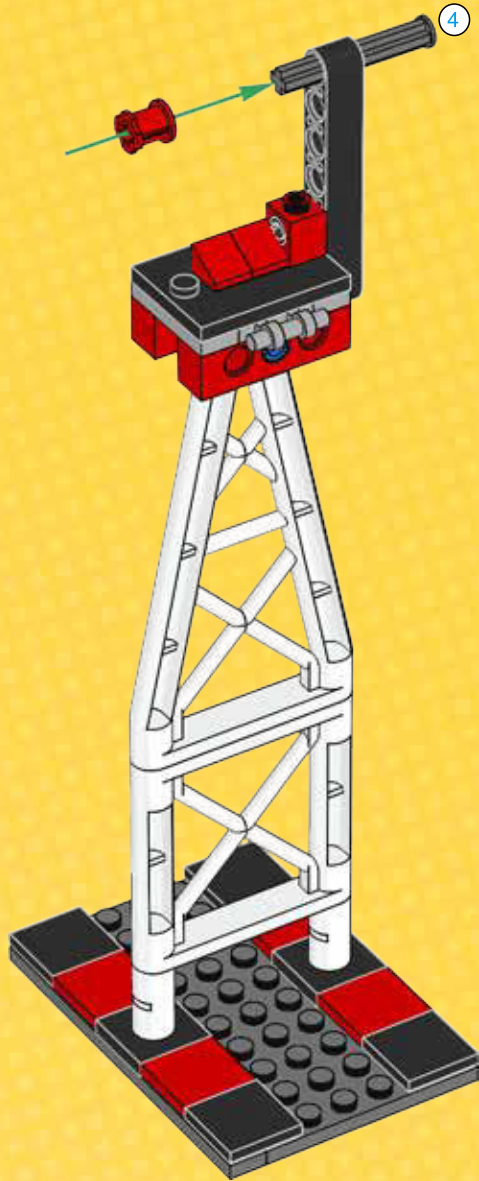

16

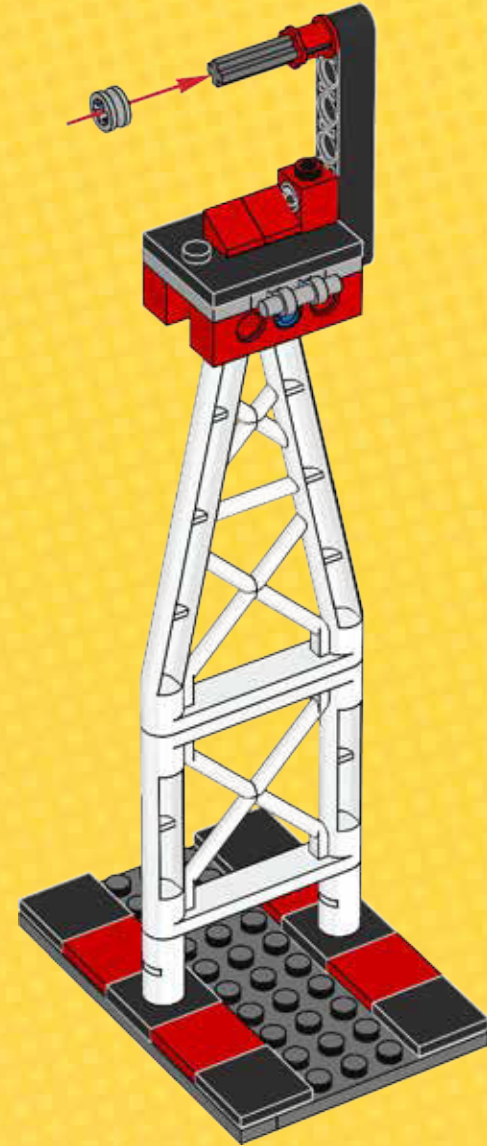

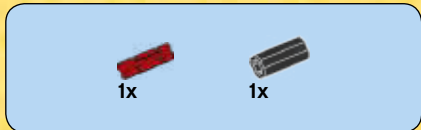

1

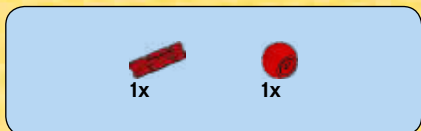
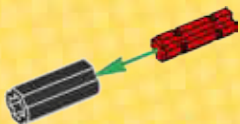

2

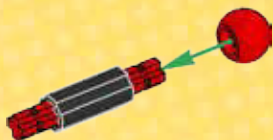

3

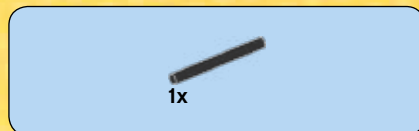

4



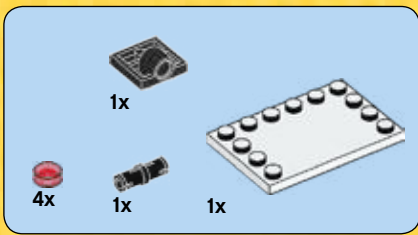

5

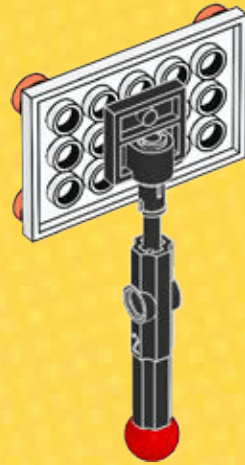
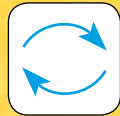
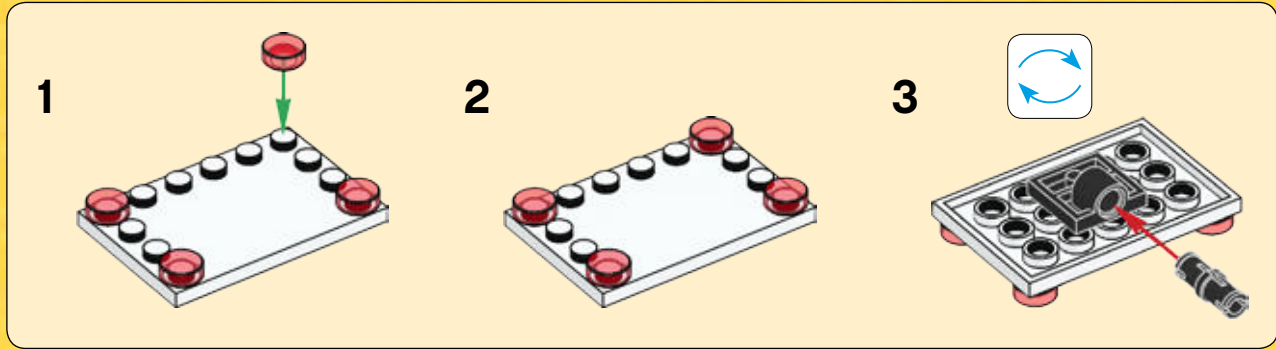

1x

17

6

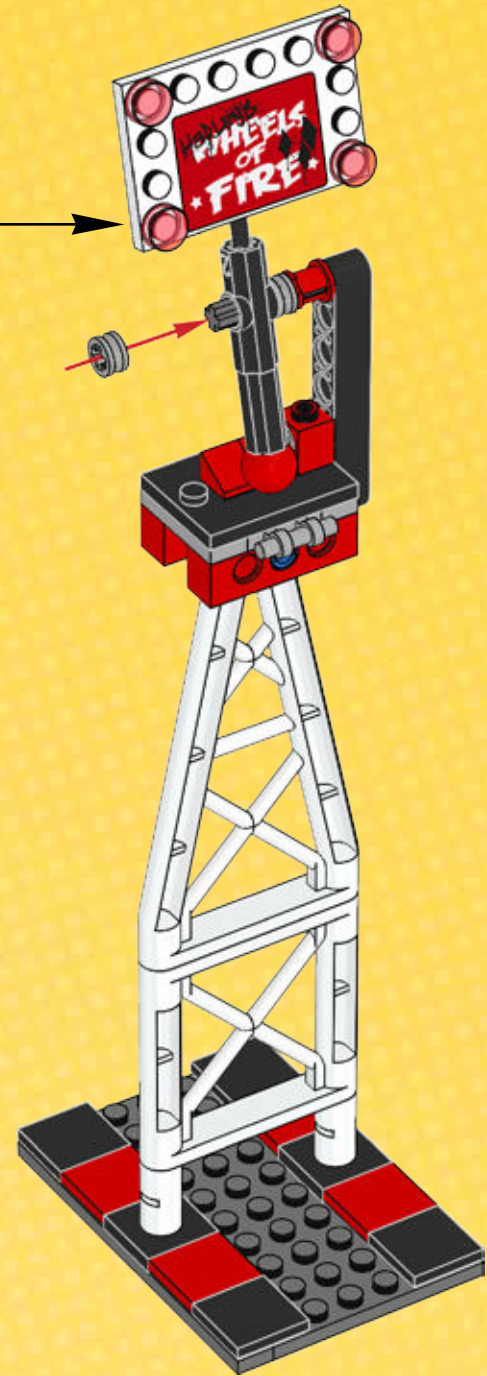
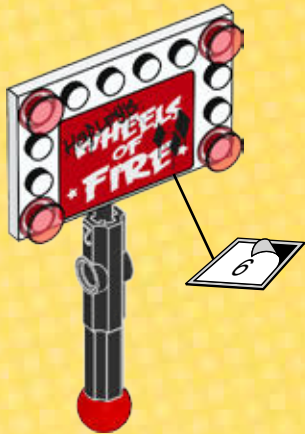



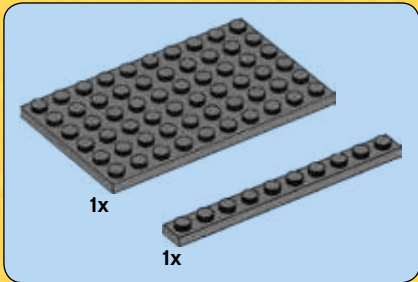

1

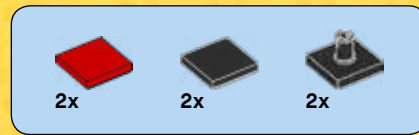
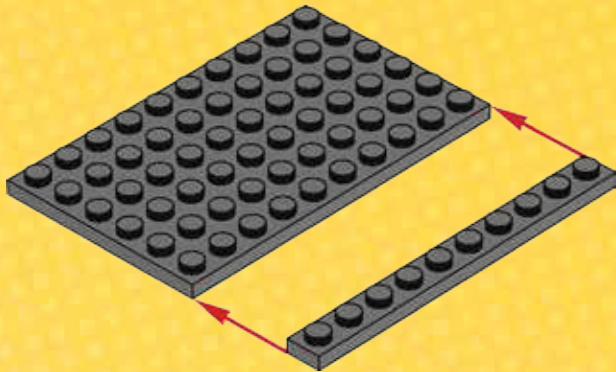

2

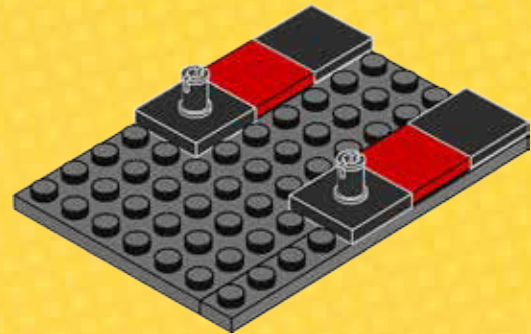



3

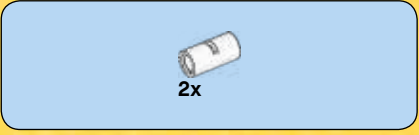
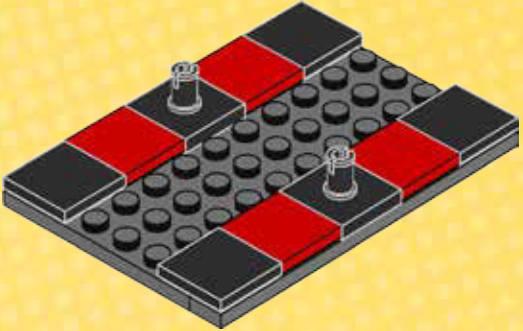

4

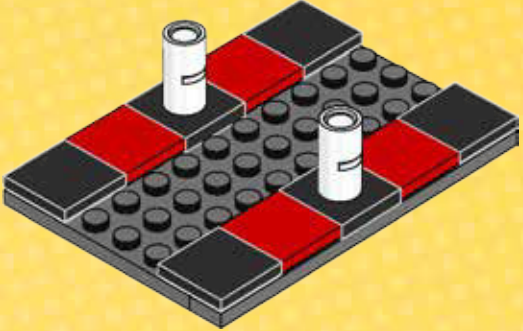

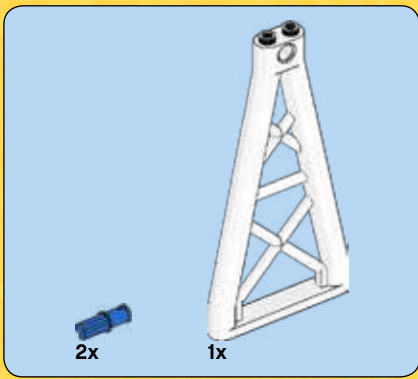

5

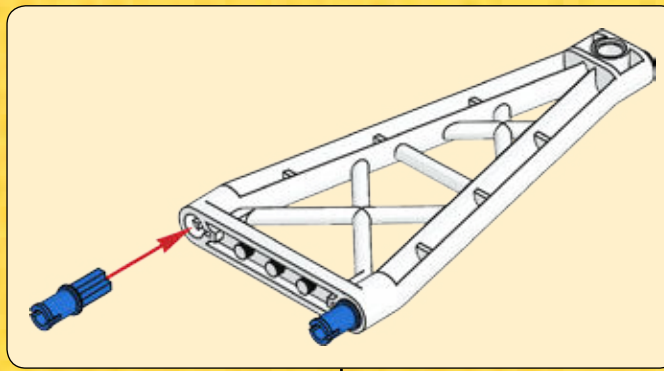



6

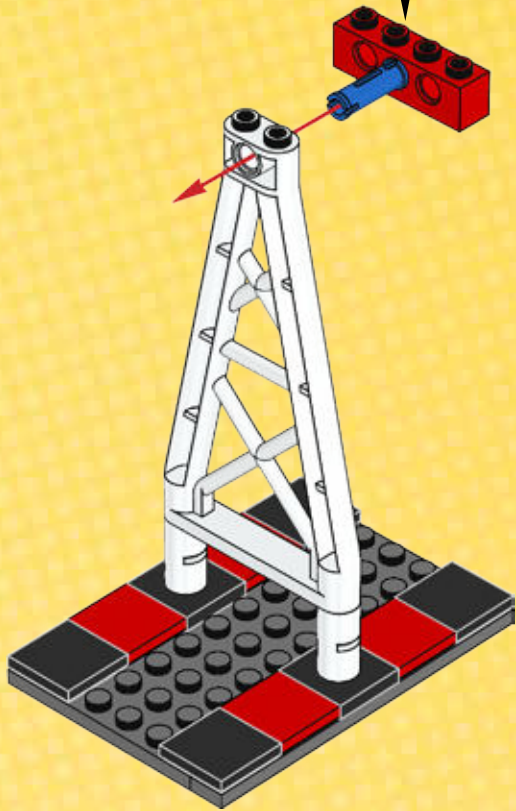
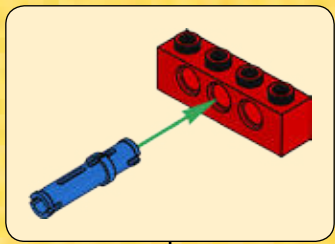

7





8



9



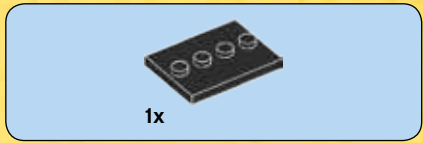

10



11

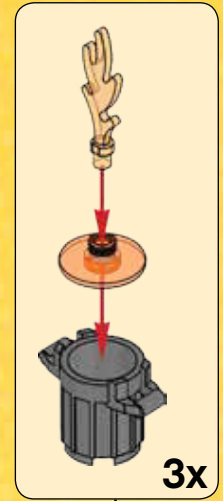
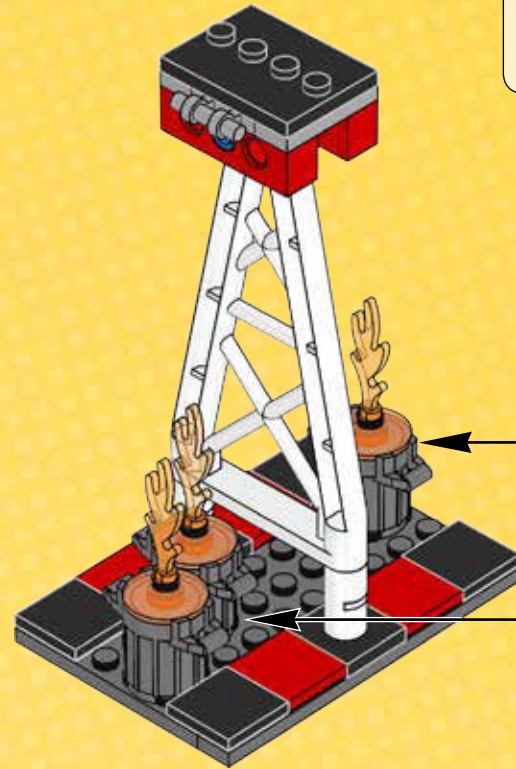

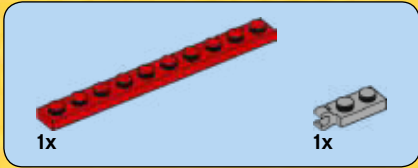

1

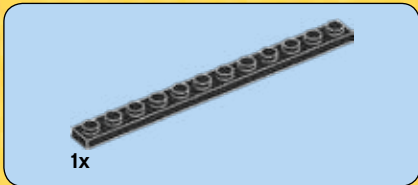
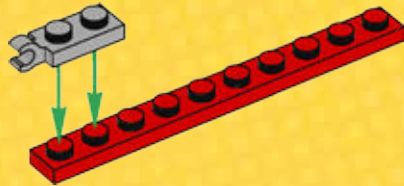

2

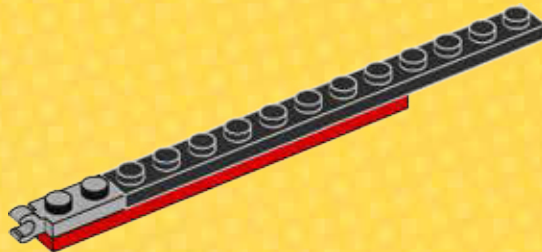

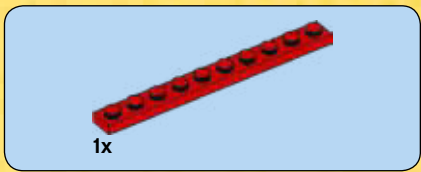

3

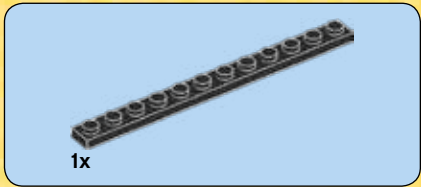
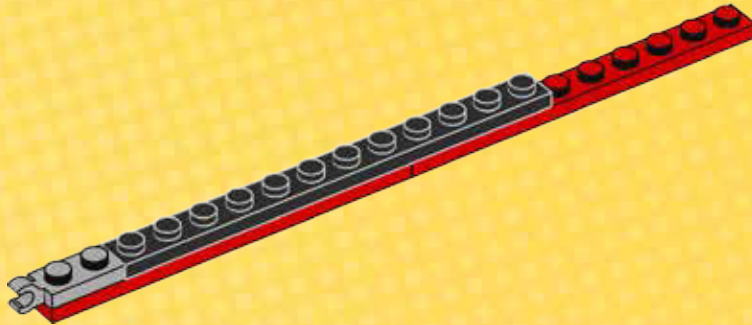

4

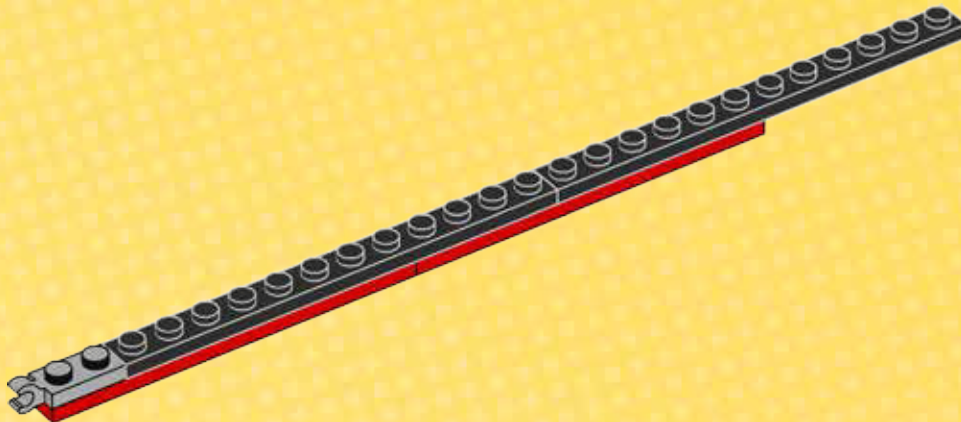



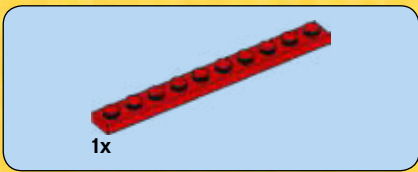

5

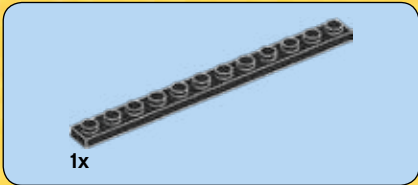
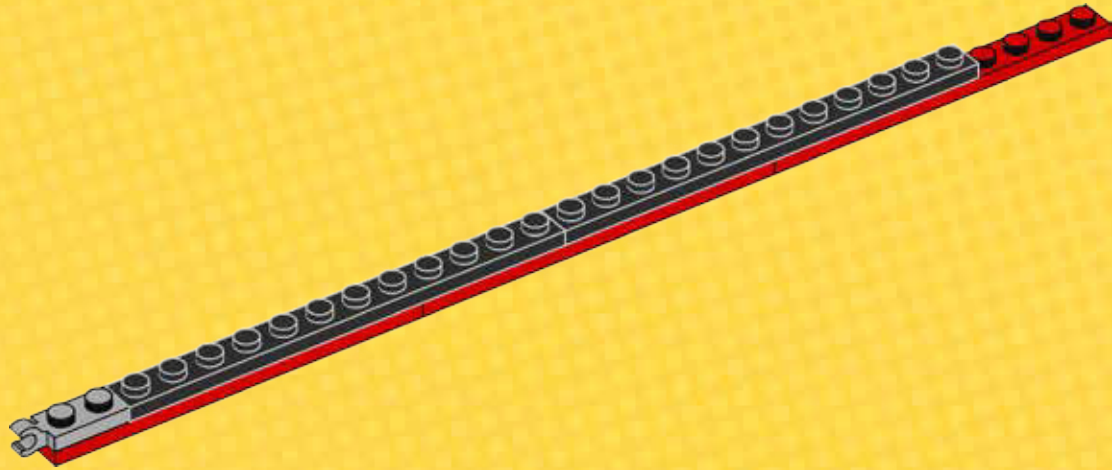

6

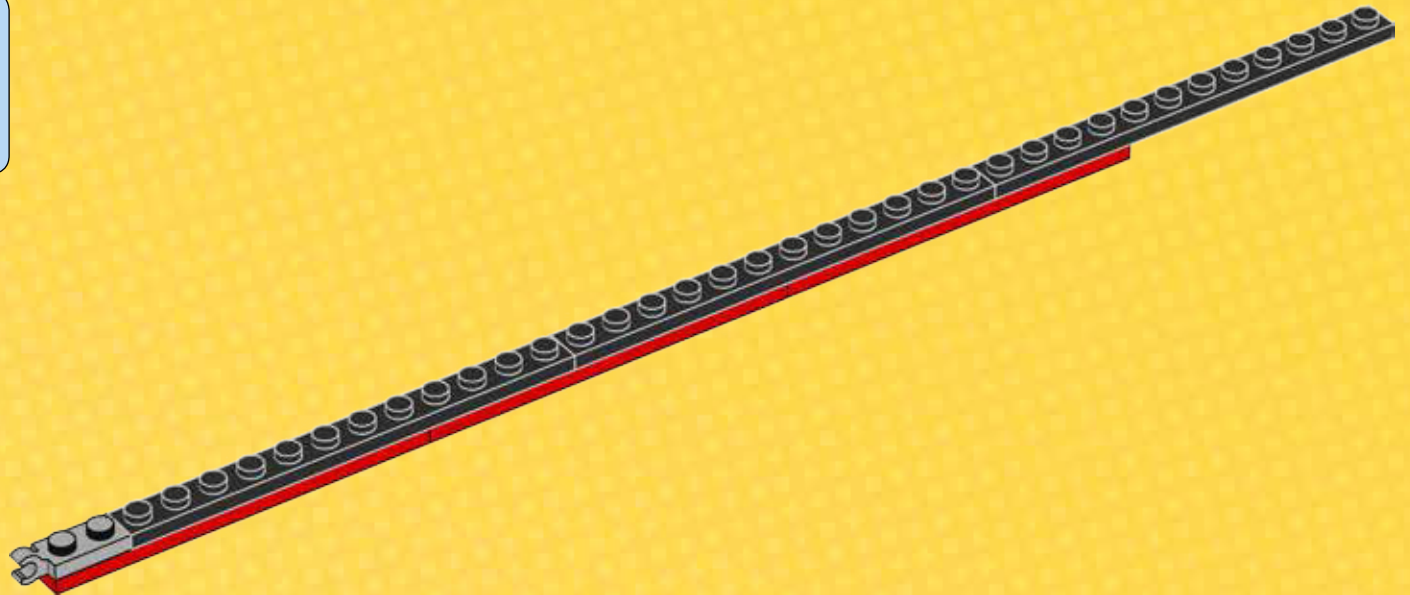

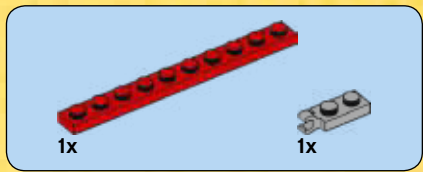

7

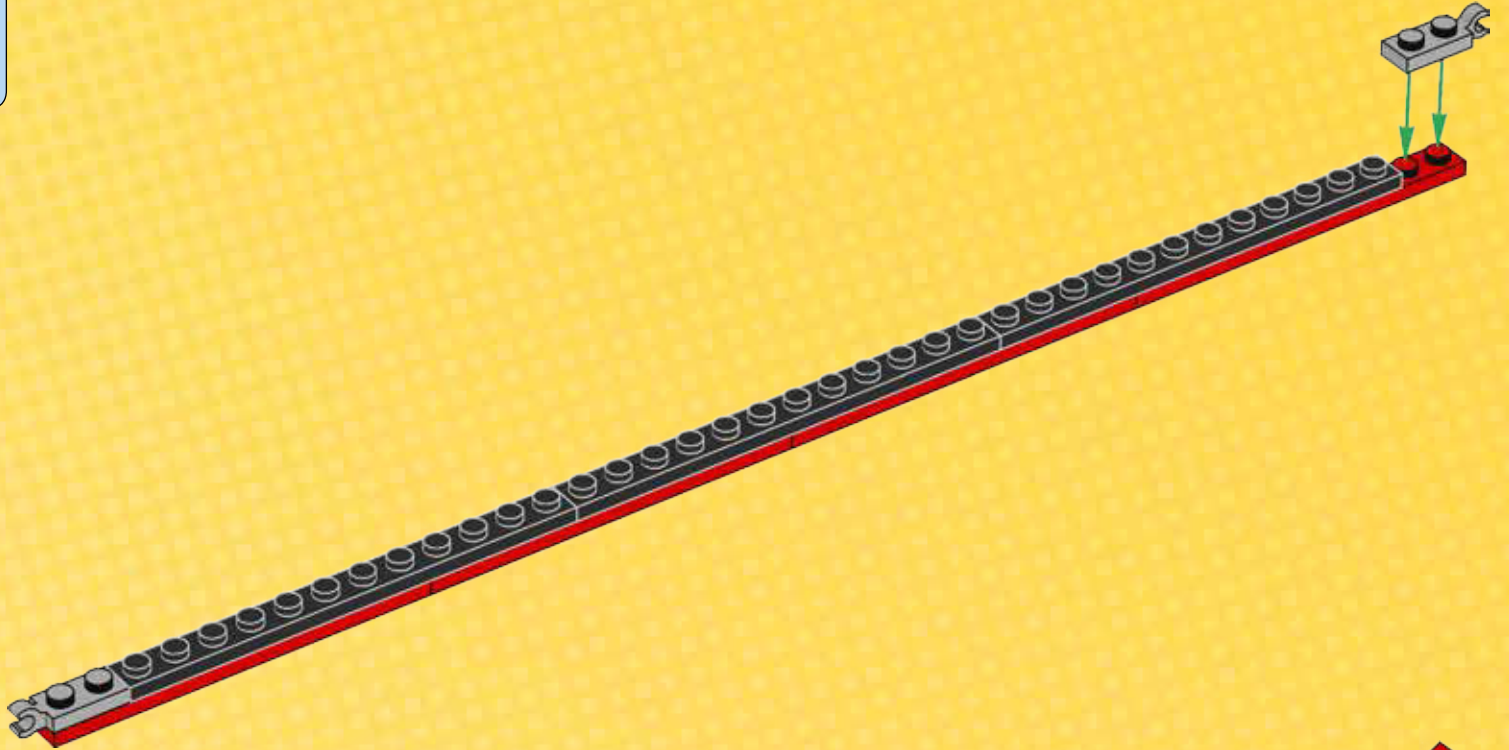

8

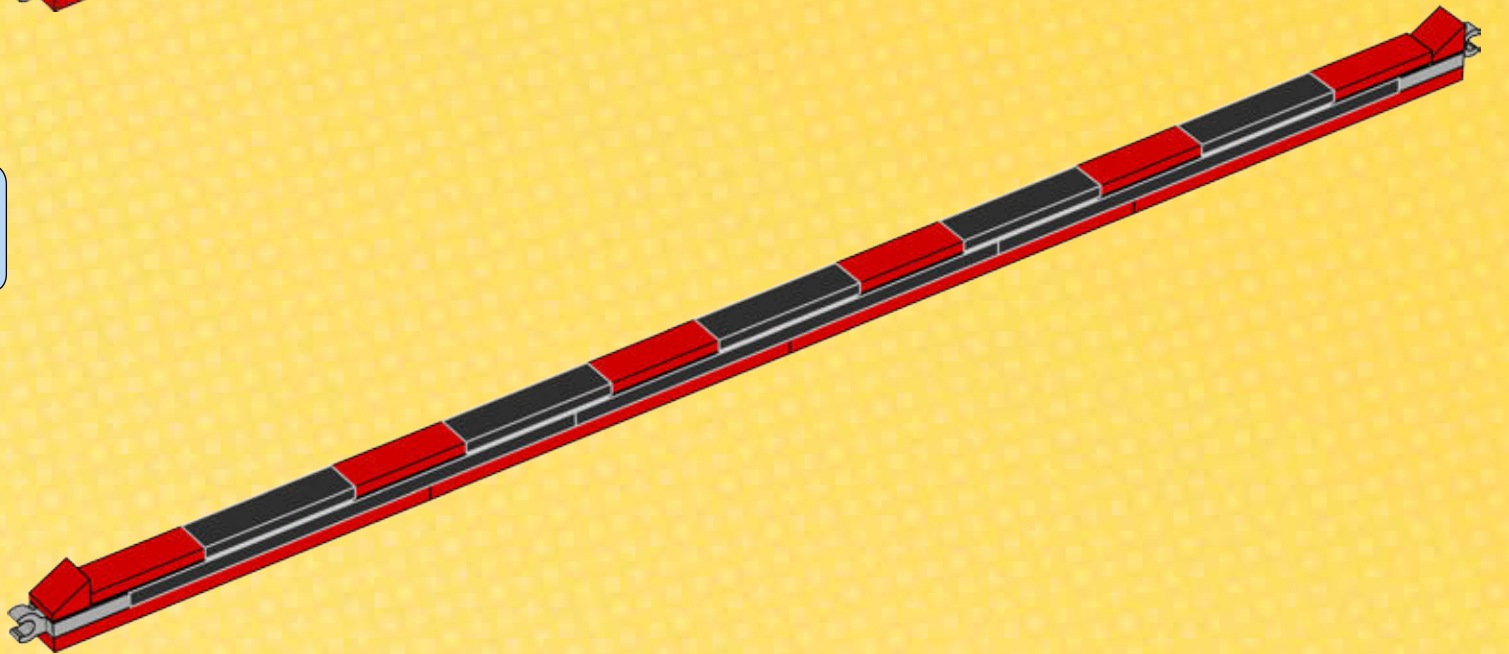

12

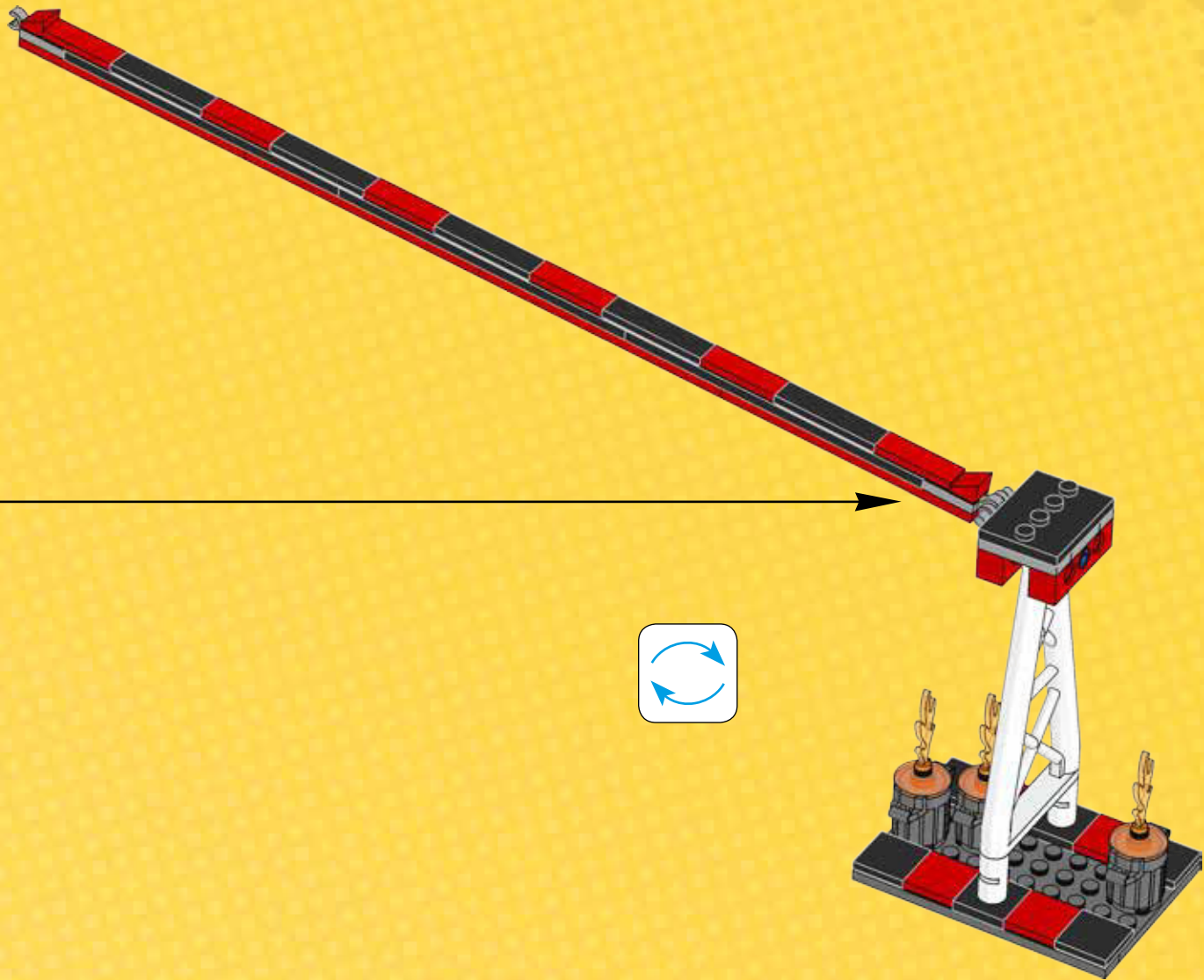

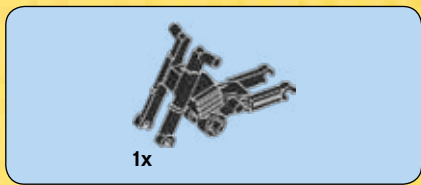

1



2

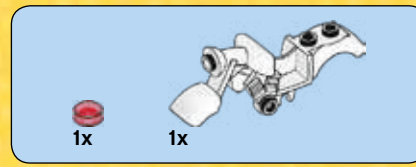
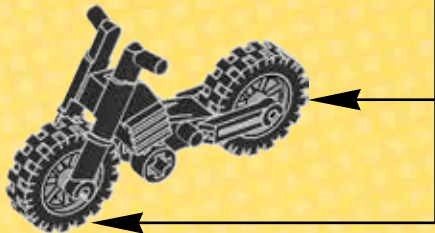
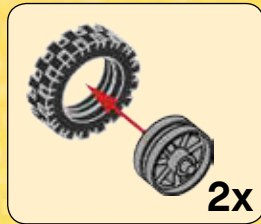

3

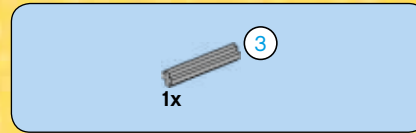
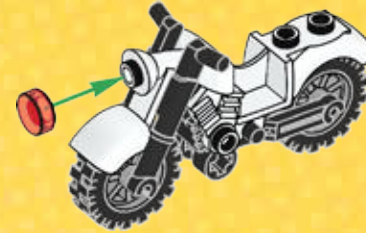

4

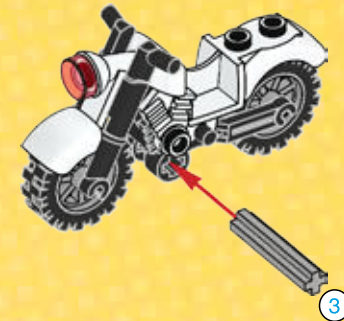
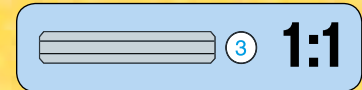

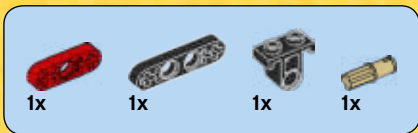

5

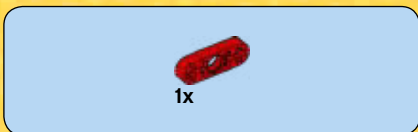
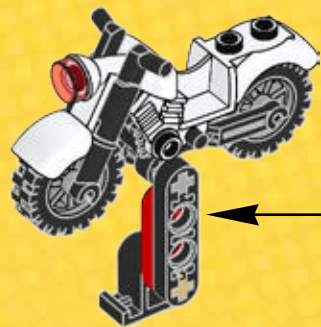
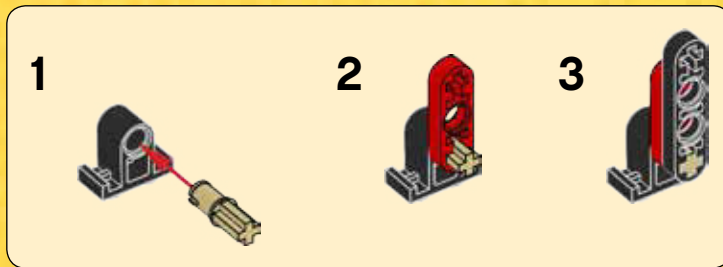

6

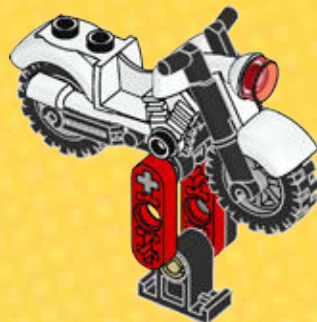
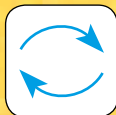

18

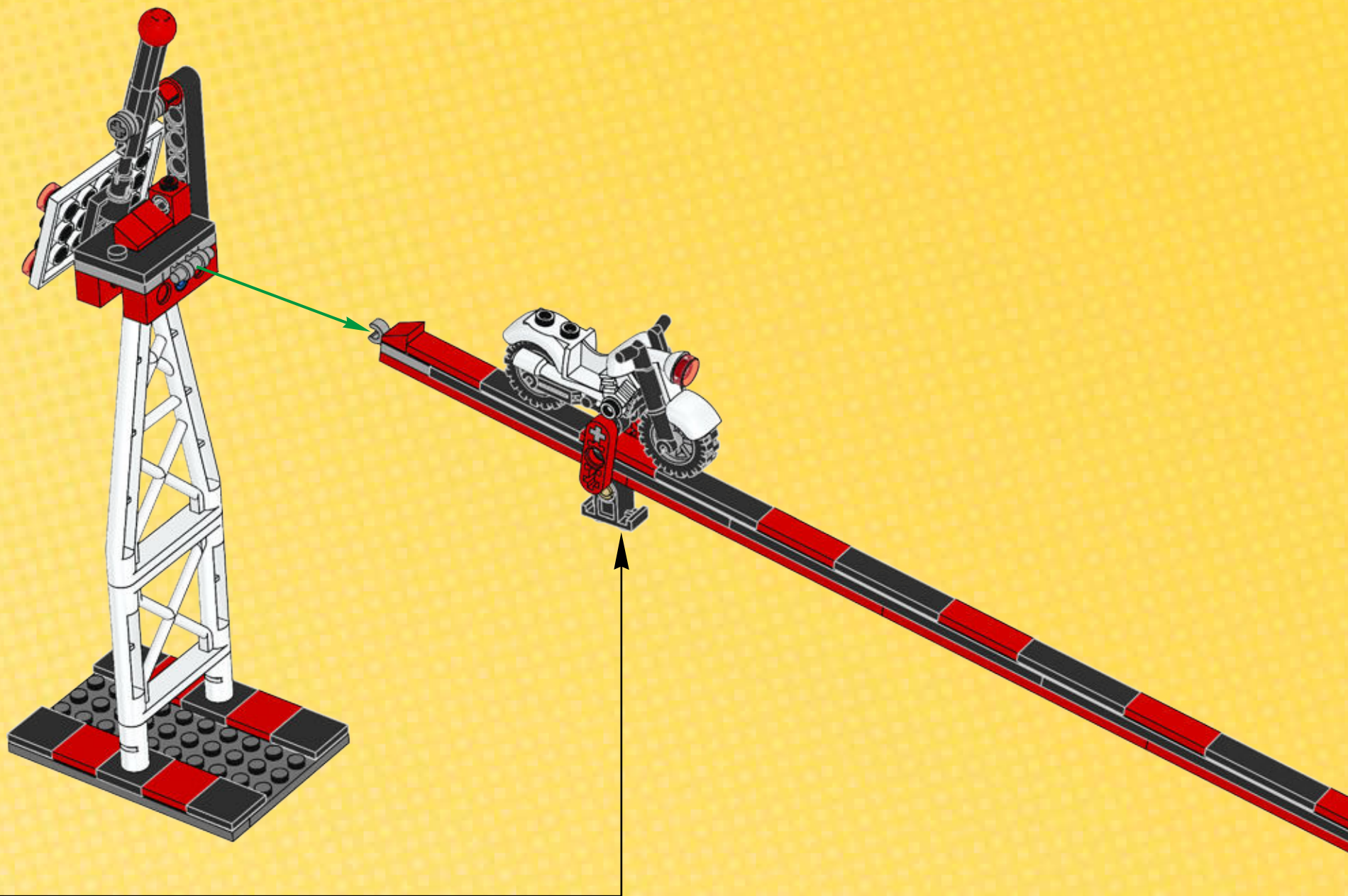

19



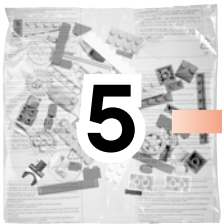

5

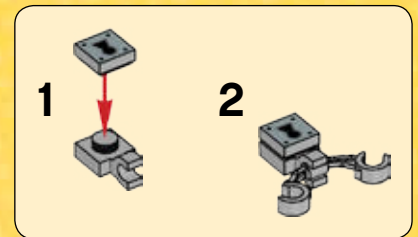
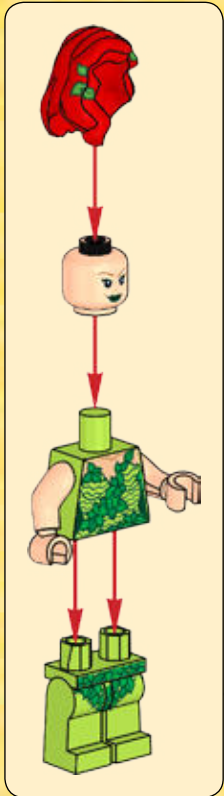

1



2

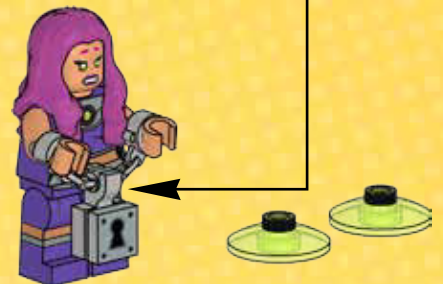



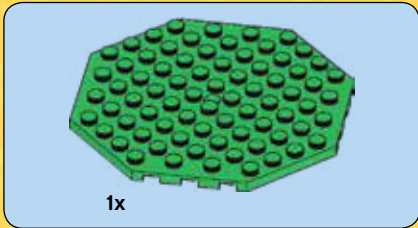

1

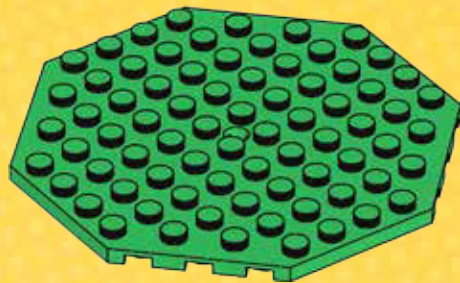

2

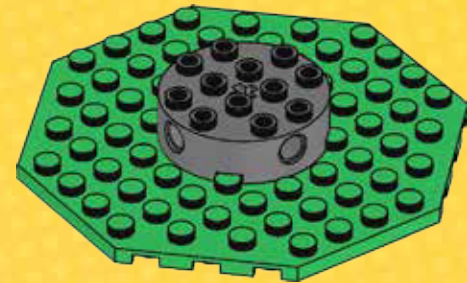



3

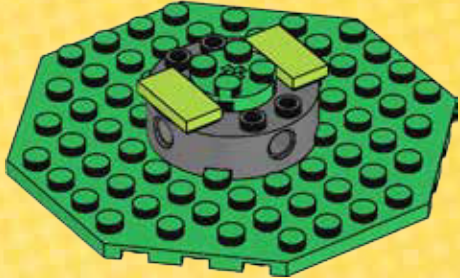

4

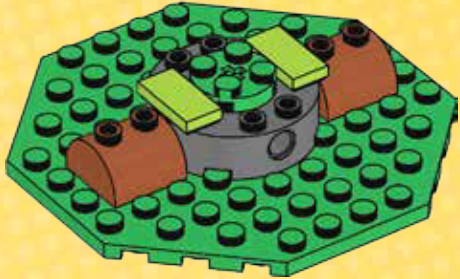

5

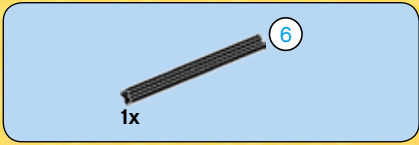

6



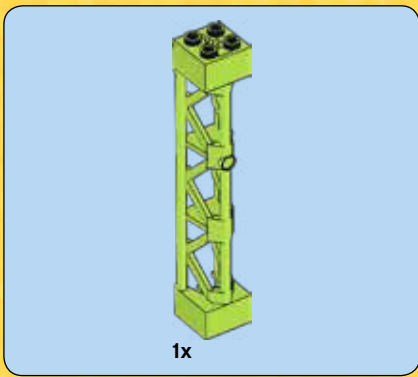

7

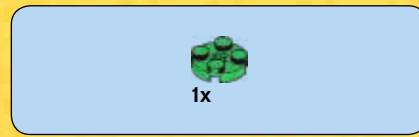
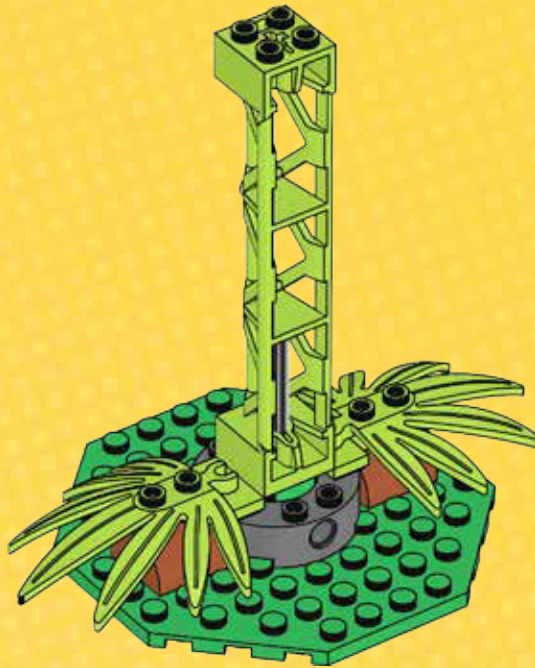

8

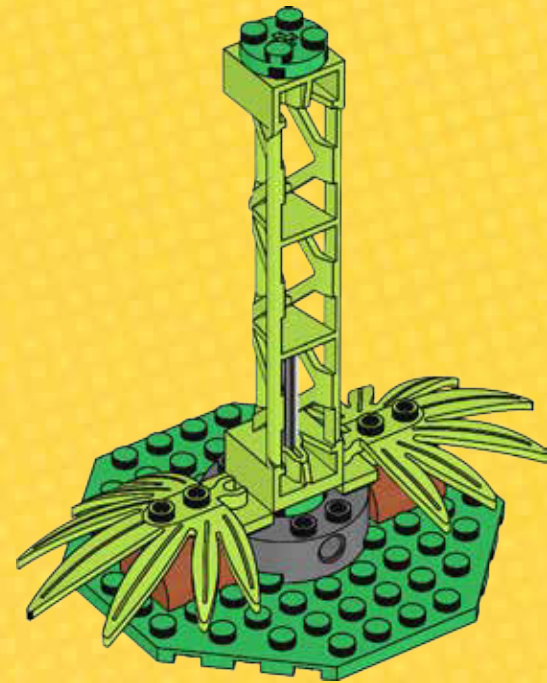

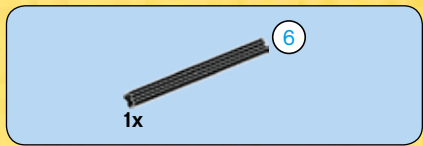

9

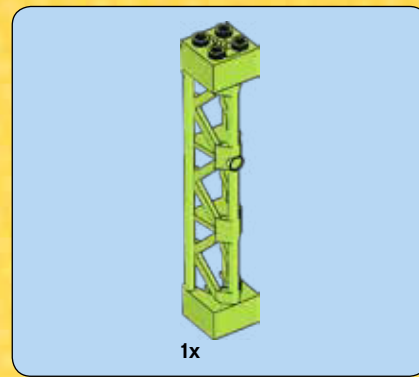
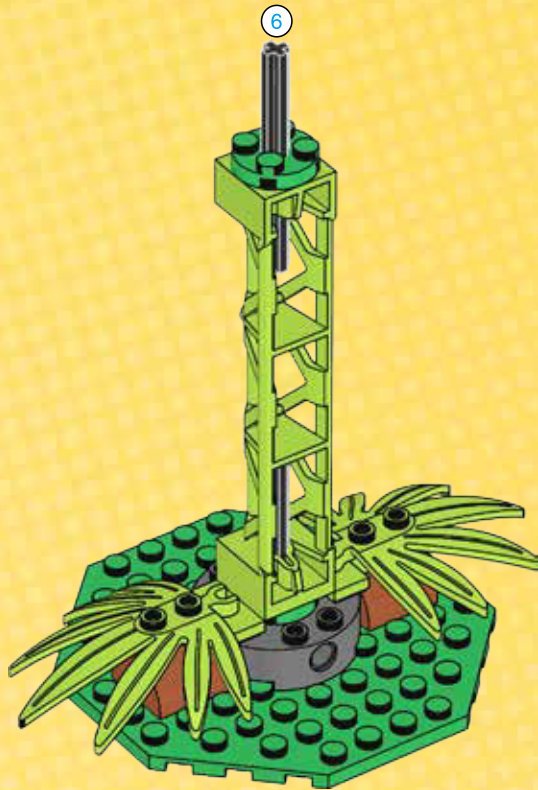

10

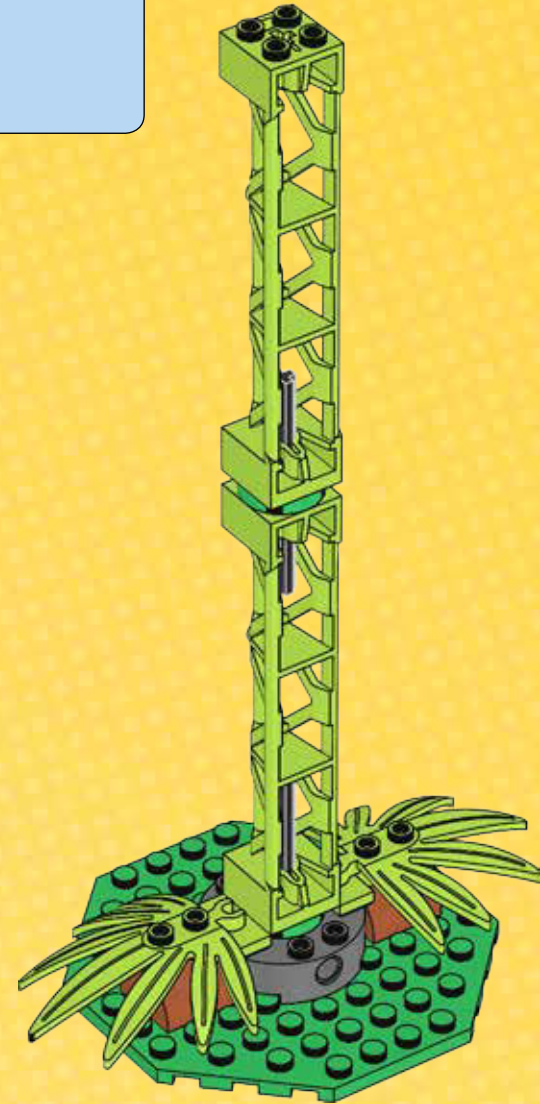



1x

11

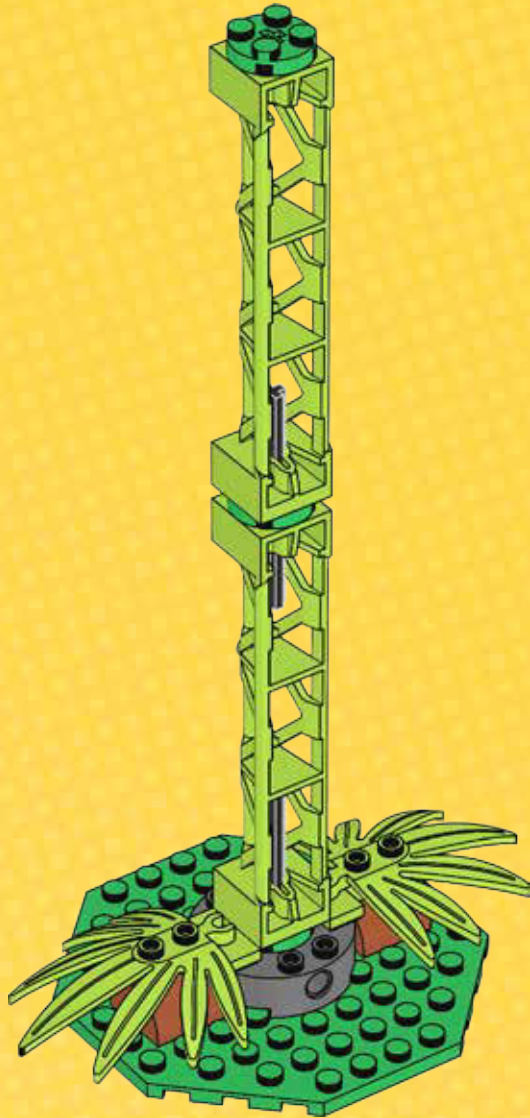

2x

12

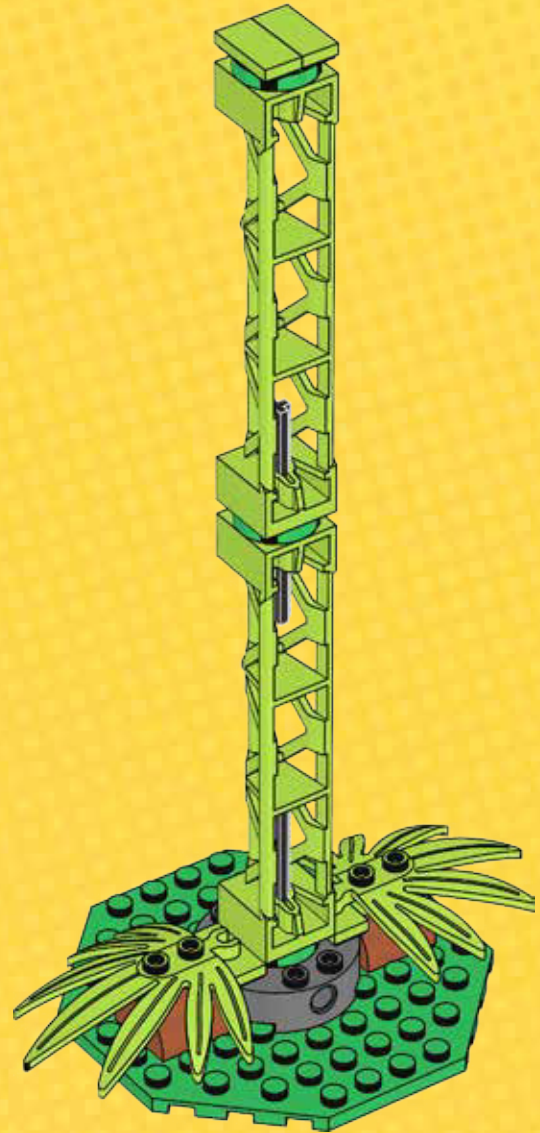

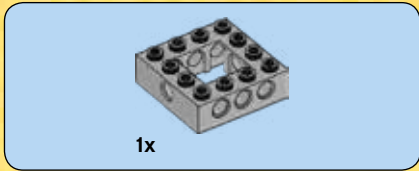

1

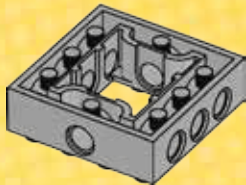

2

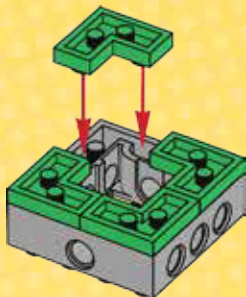

3

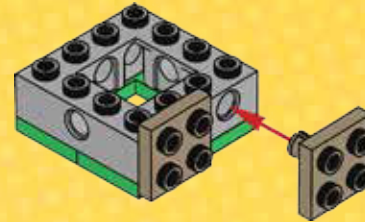
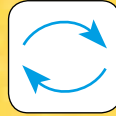

4

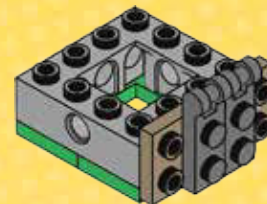



5

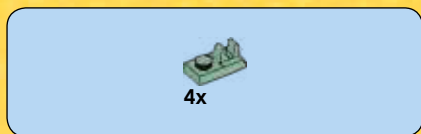
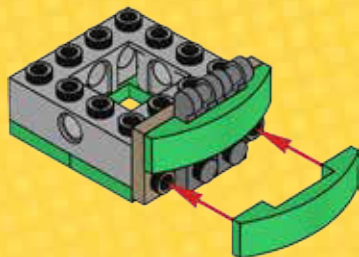

6

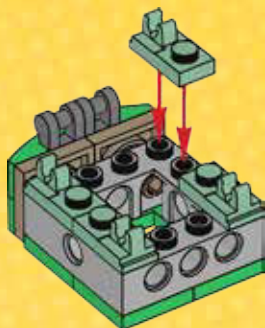
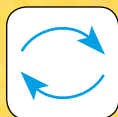

7

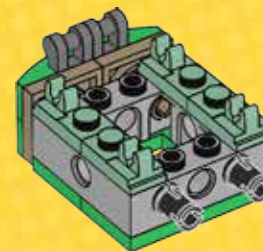

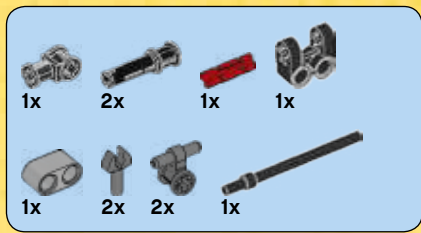

8

1

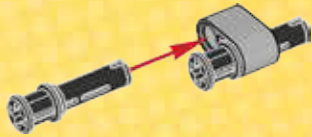

2

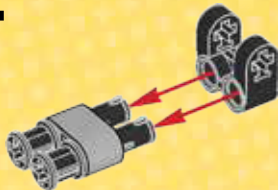

3

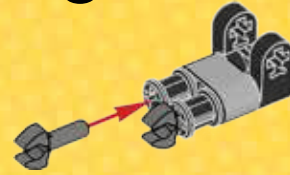

4

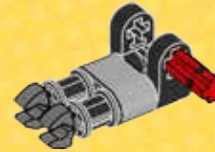

5

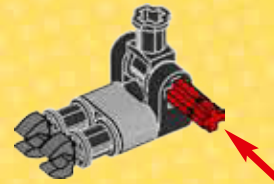



6

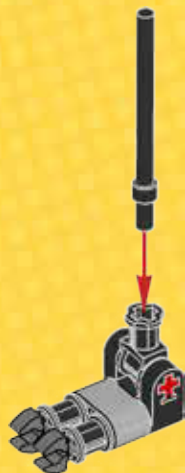

7

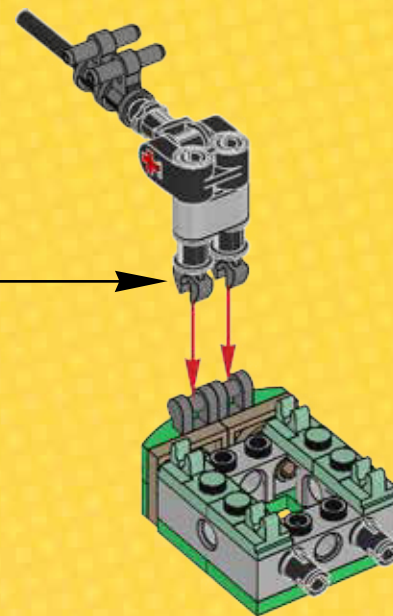



9

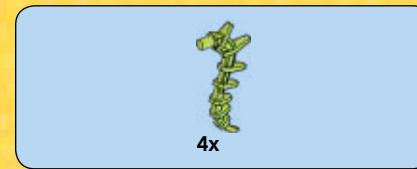
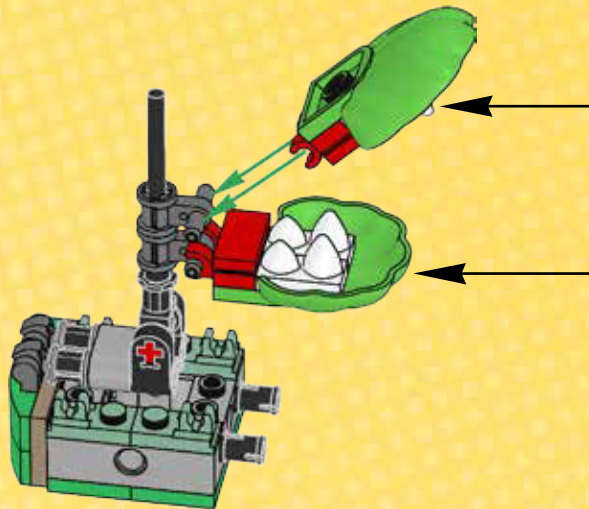

10

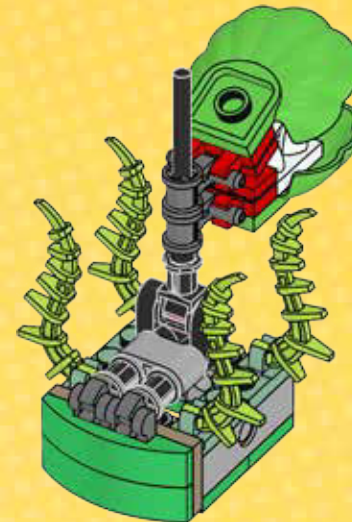
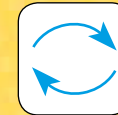

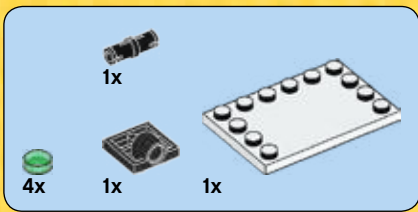

# 11

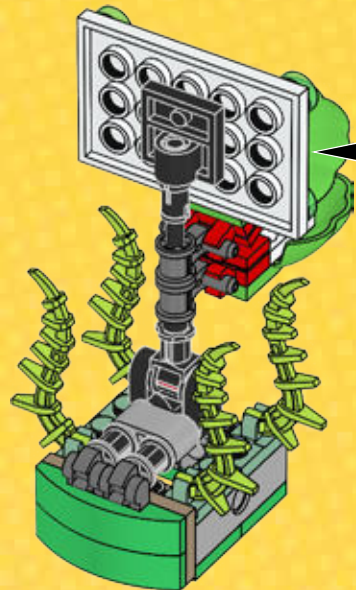
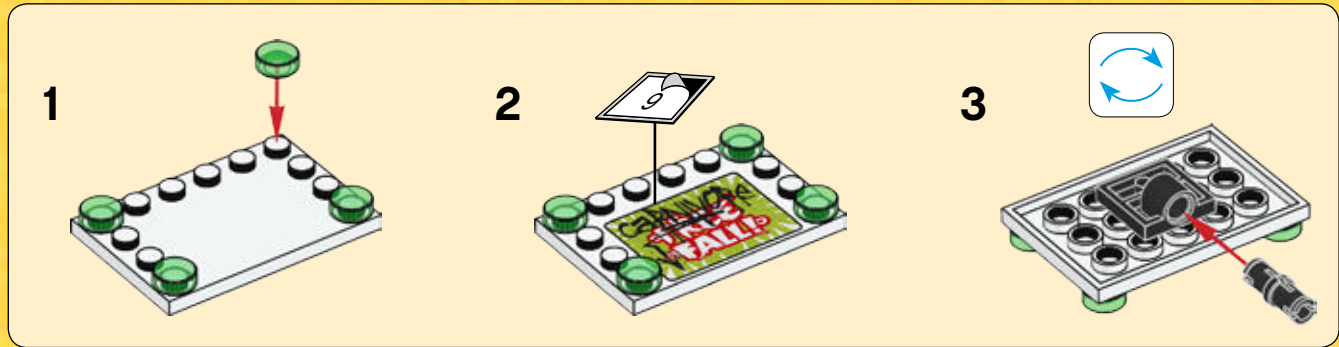

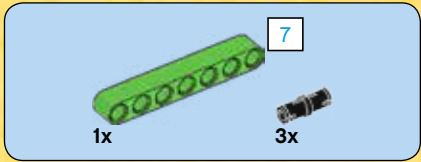
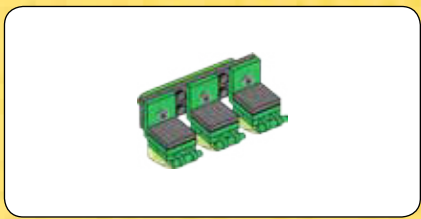

1

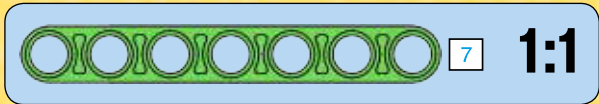
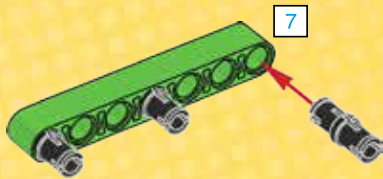

2

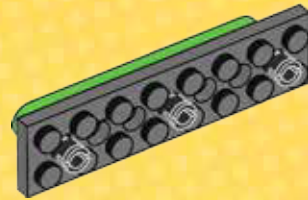

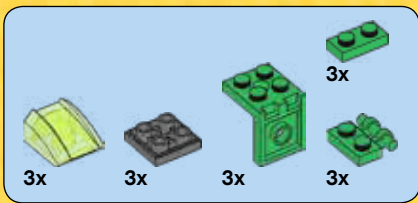

# 3

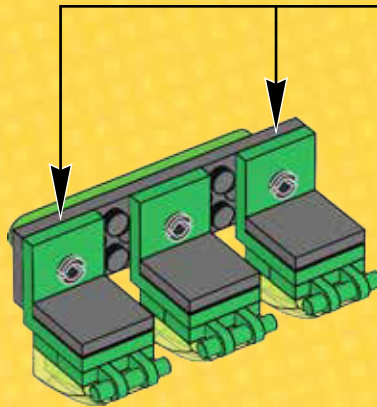
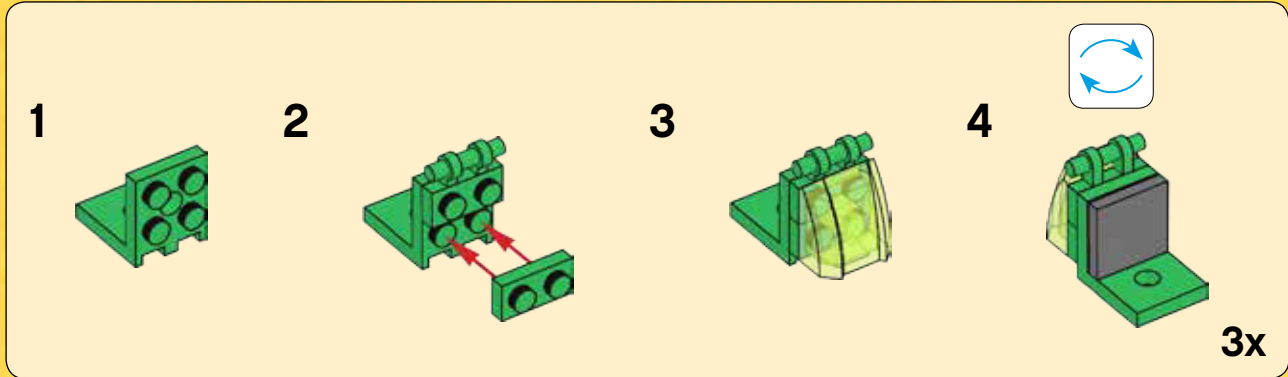

# 12

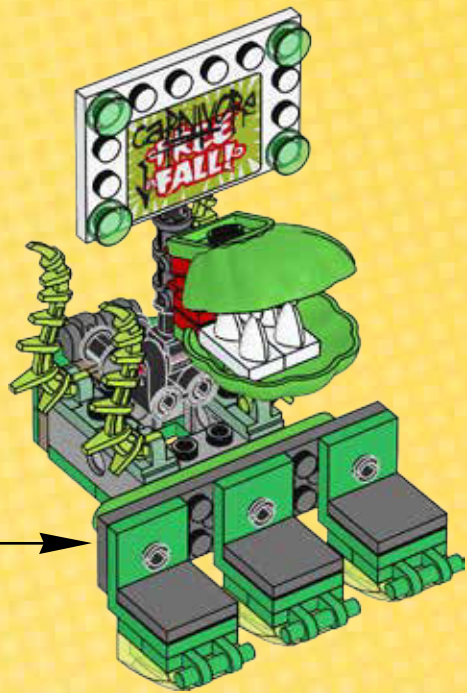

# 13

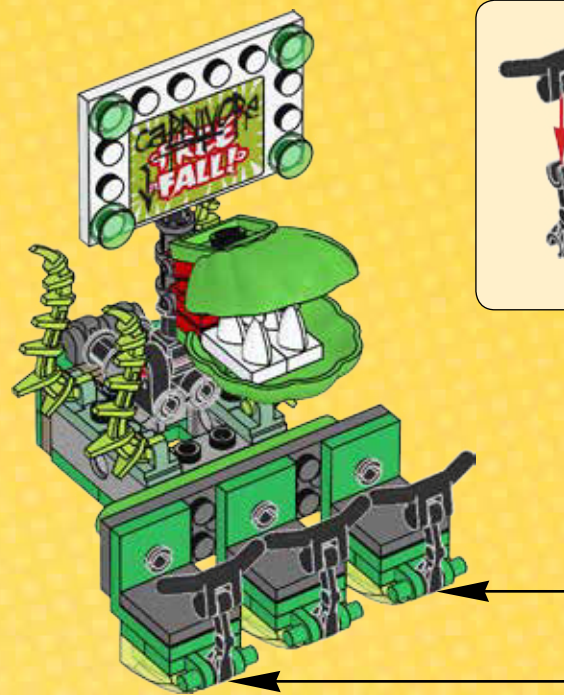
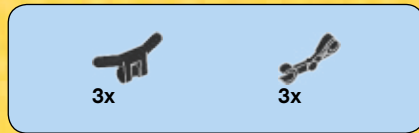

14

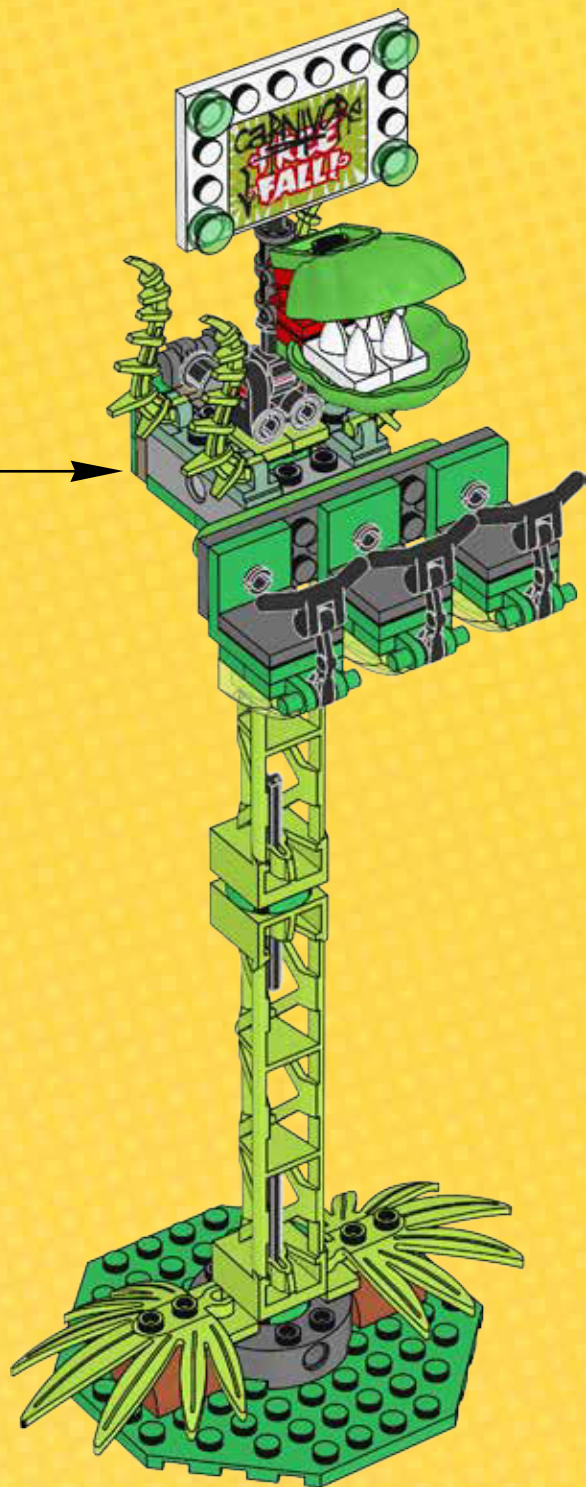

15

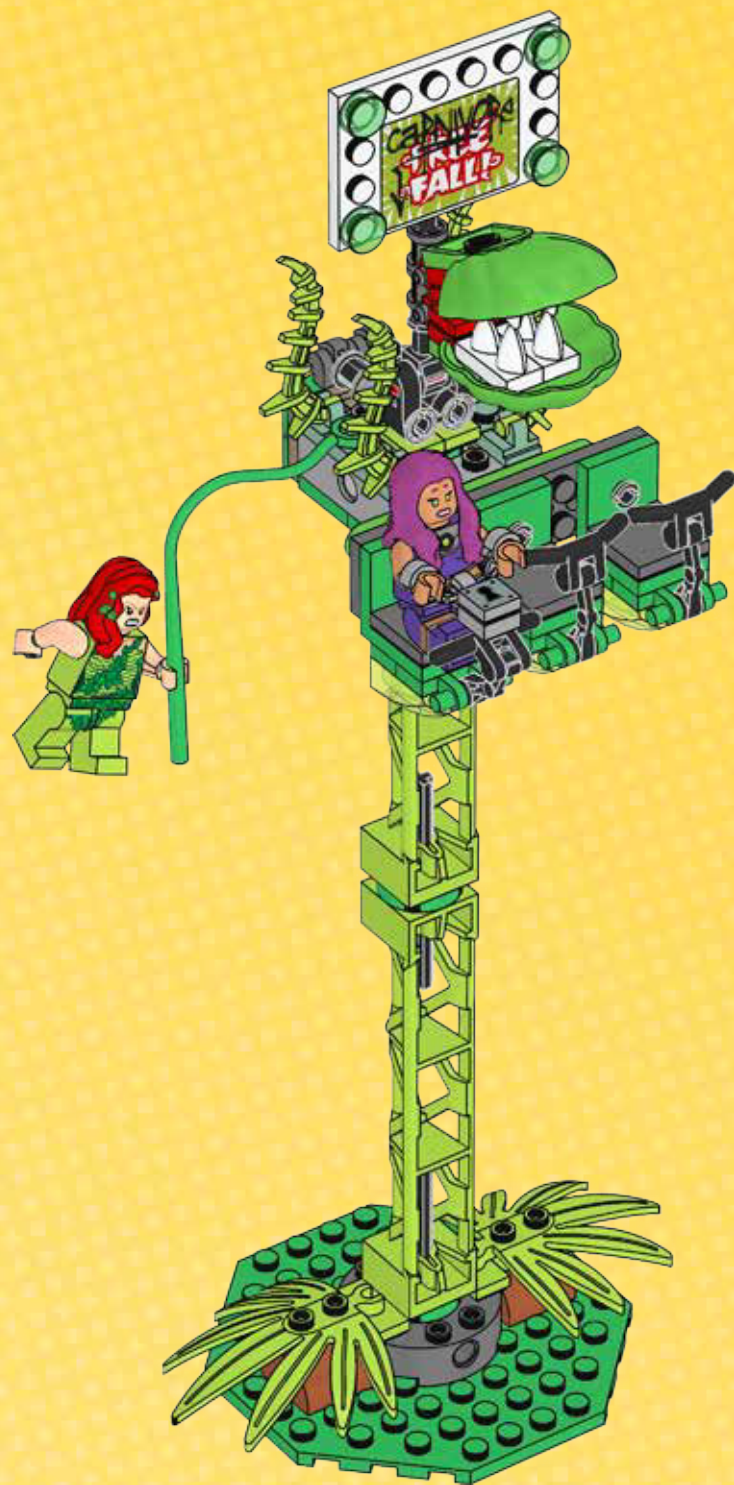



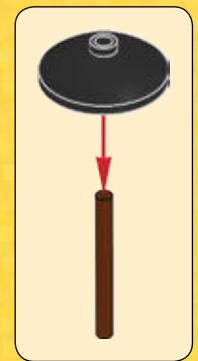
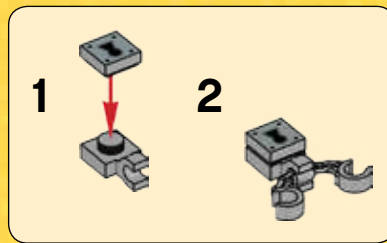
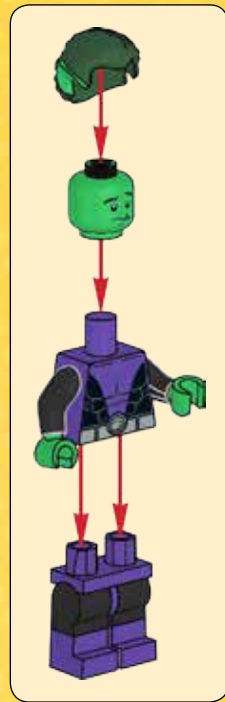
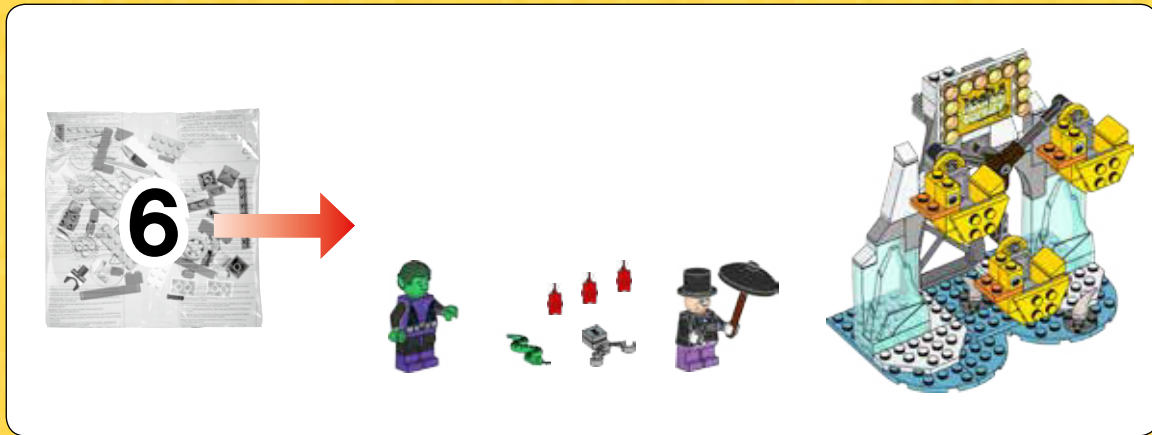

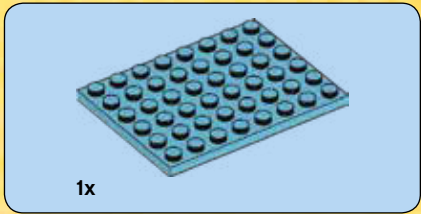

**1**

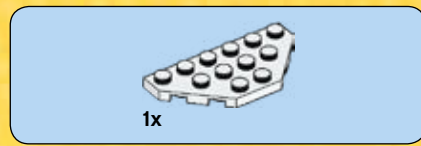
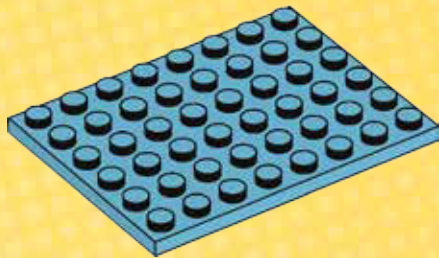

**2**

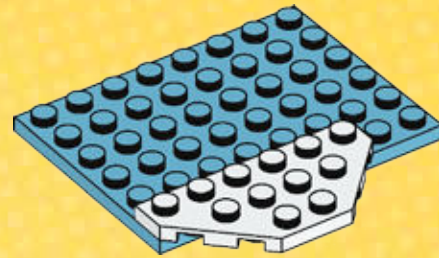

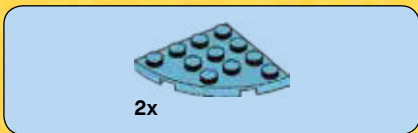

3

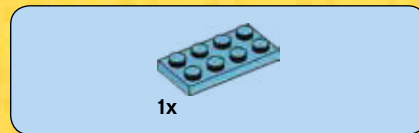
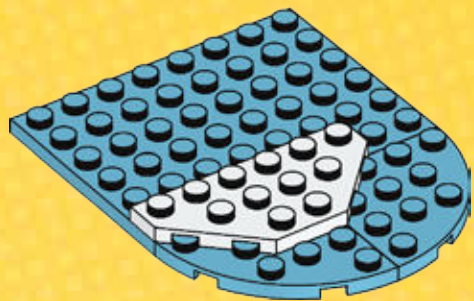

4

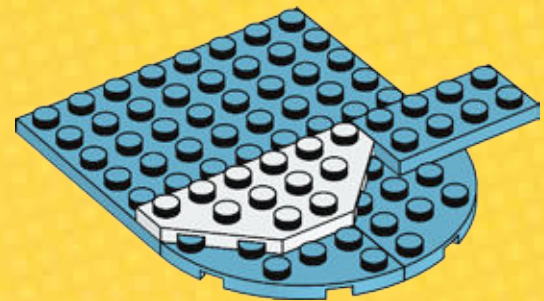

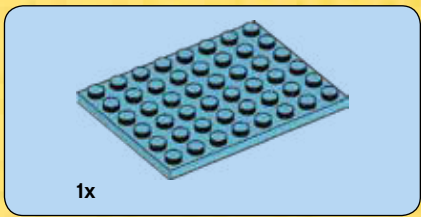

5

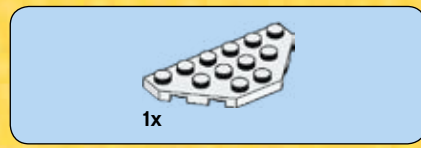
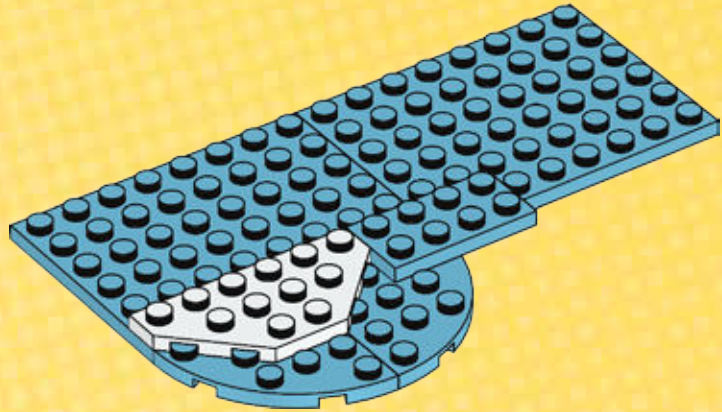

6

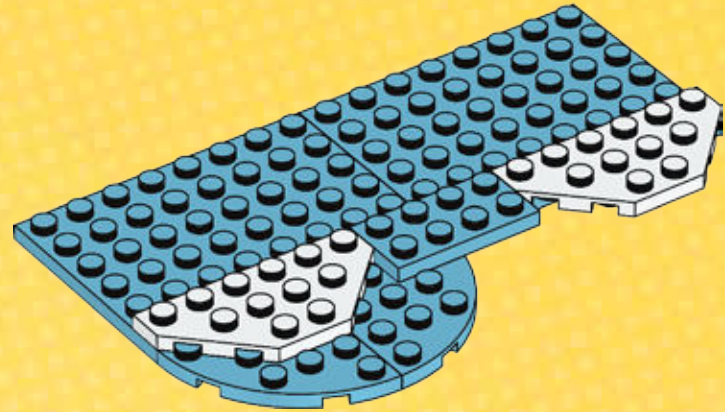



7

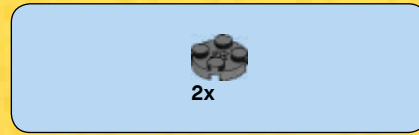
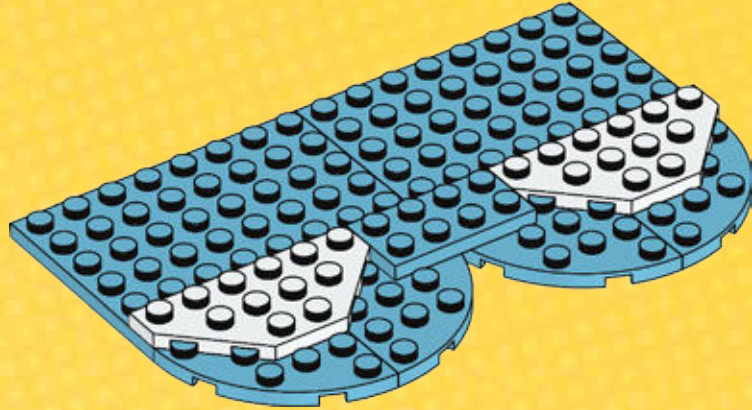

8

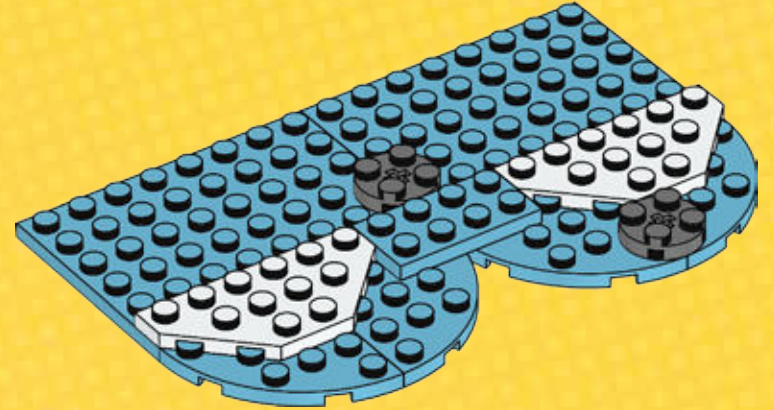

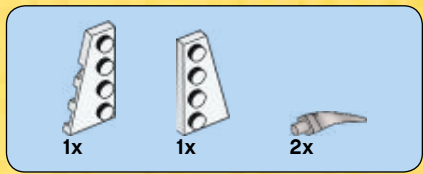

9

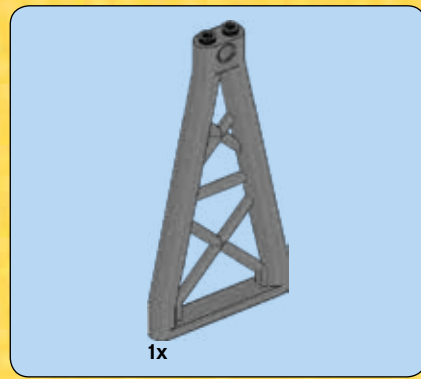
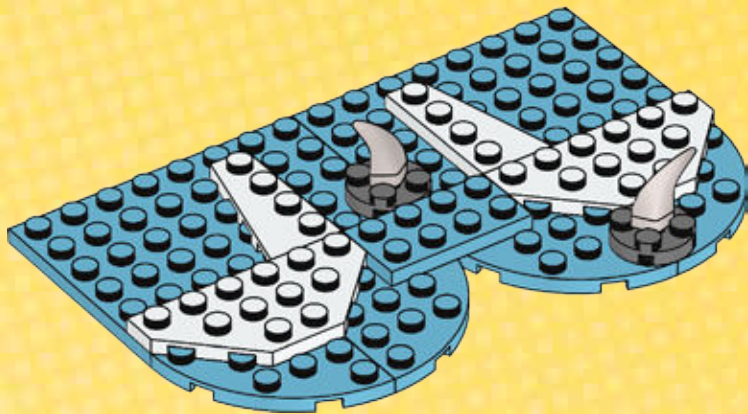

10

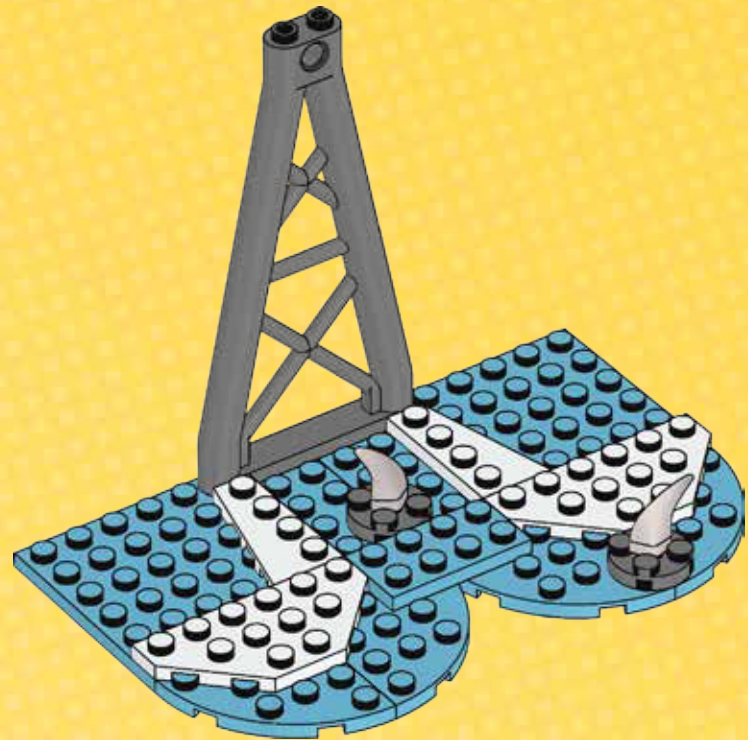

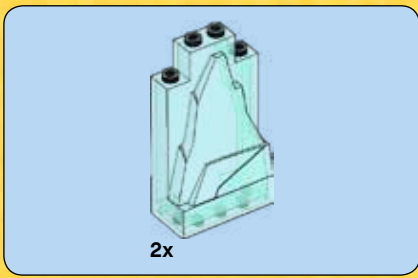

11

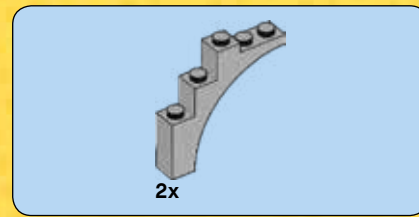
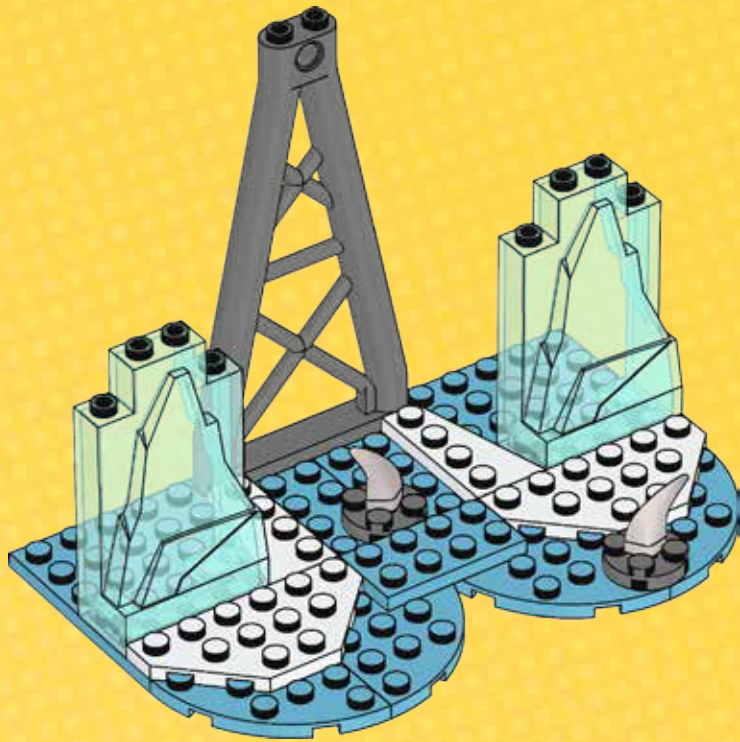

12

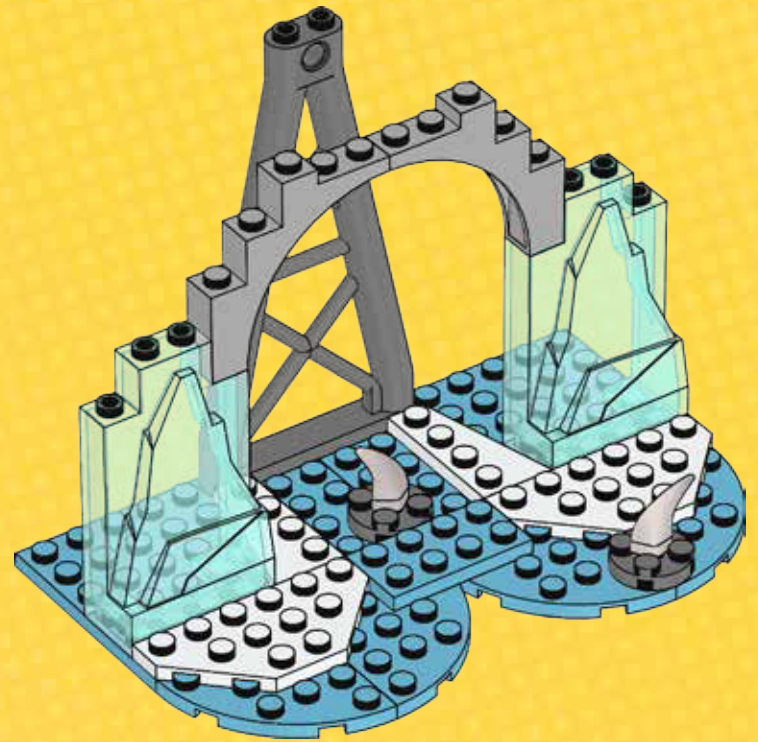



1x



2x

# 13

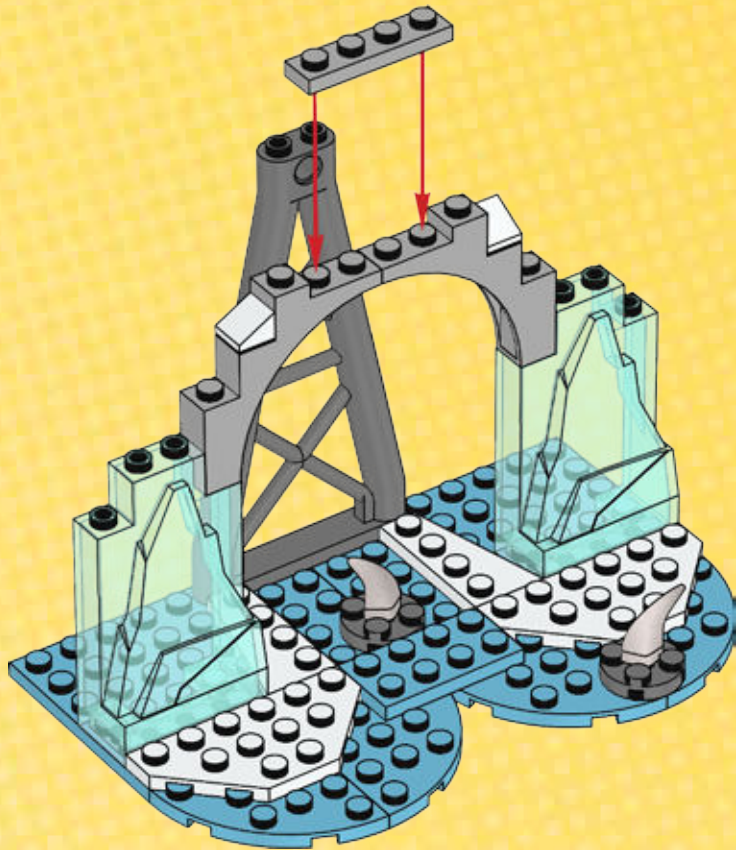

2x



2x

# 14

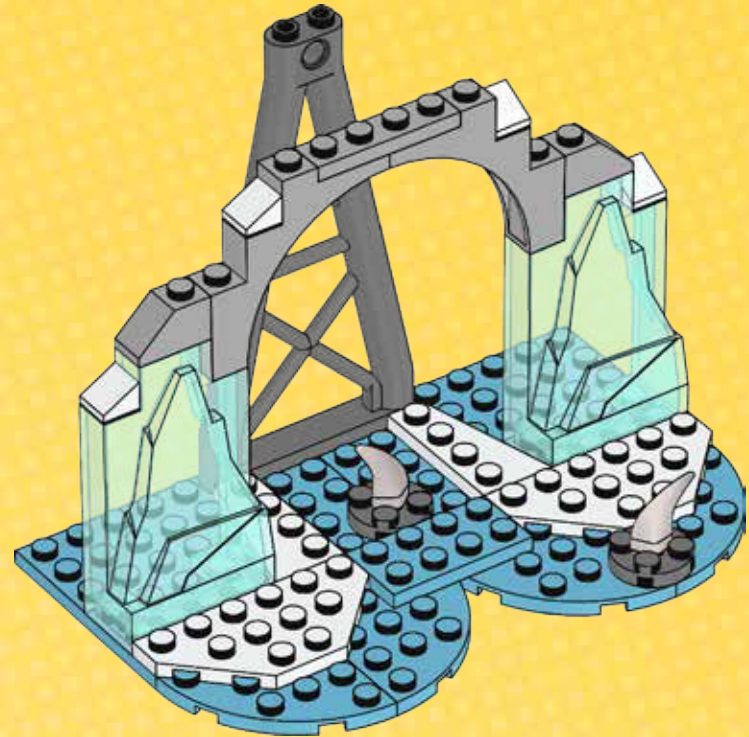



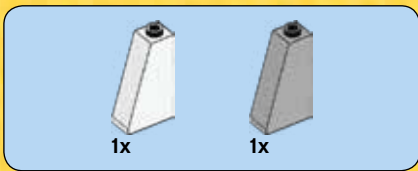

15

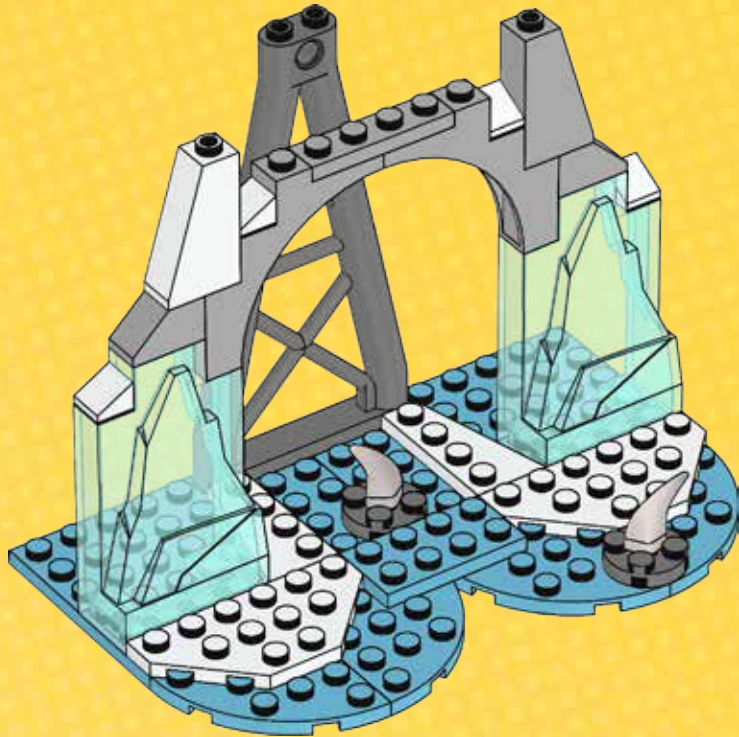

16

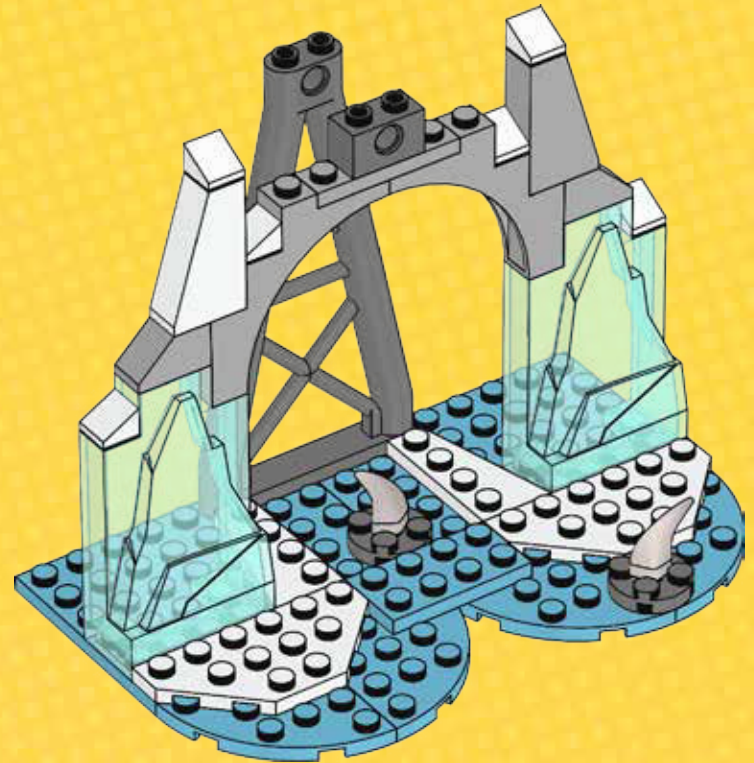



2x

# 17

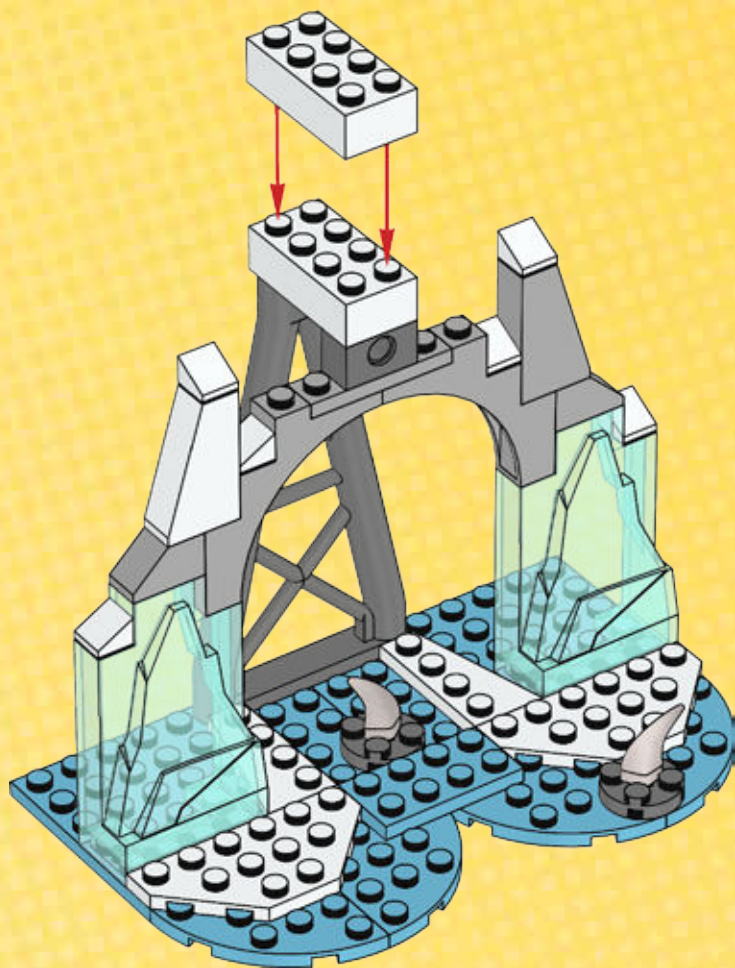

1x



1x

# 18

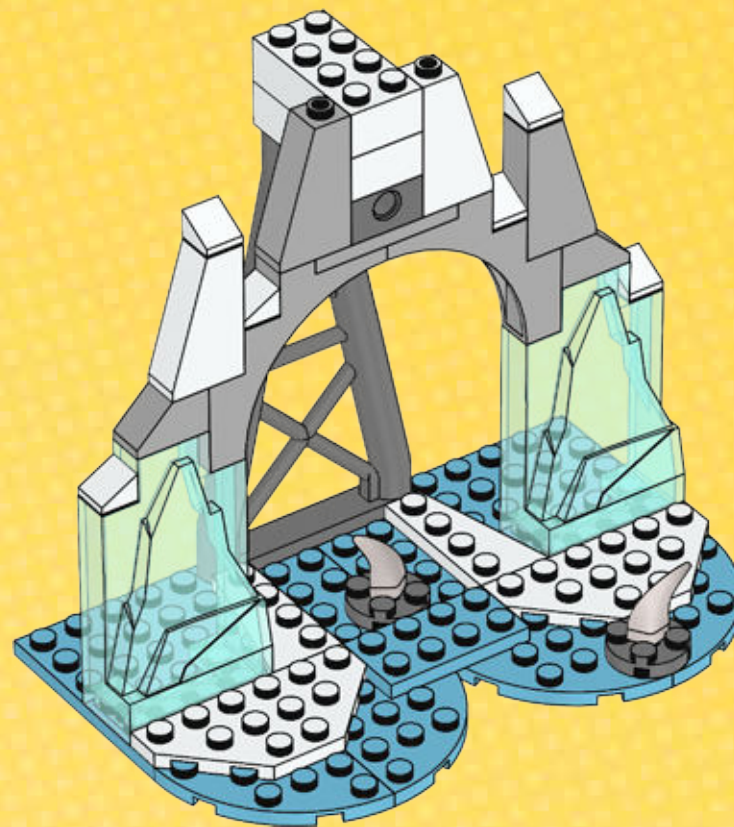



1x

# 19

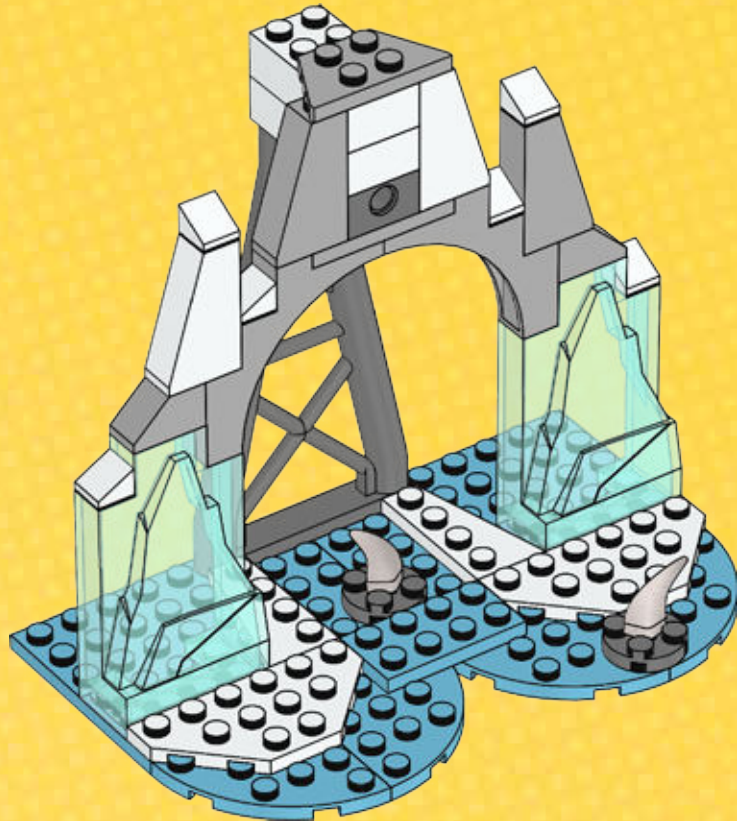

1x

# 20

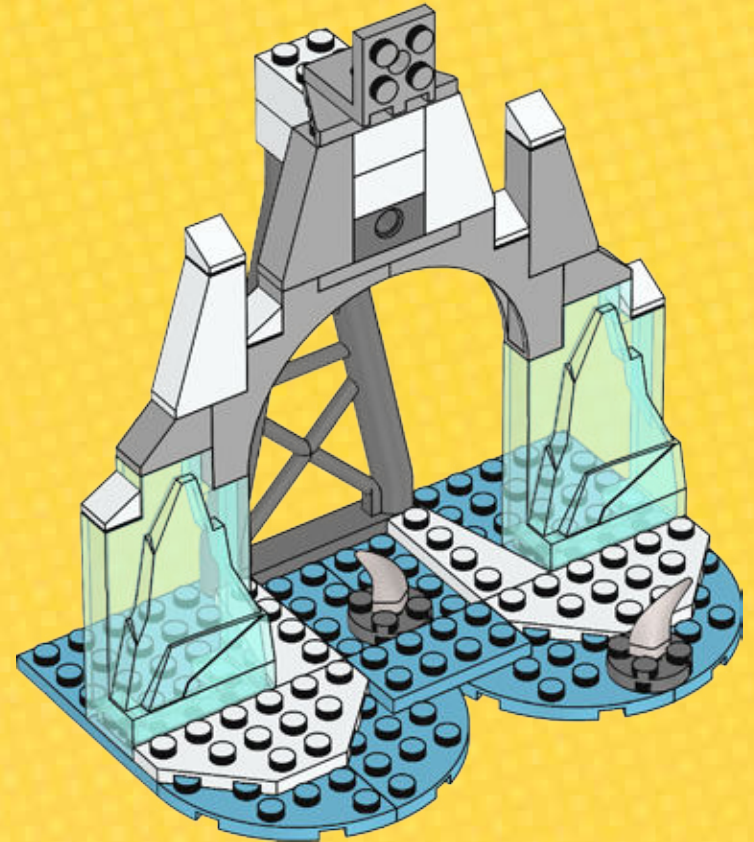



21

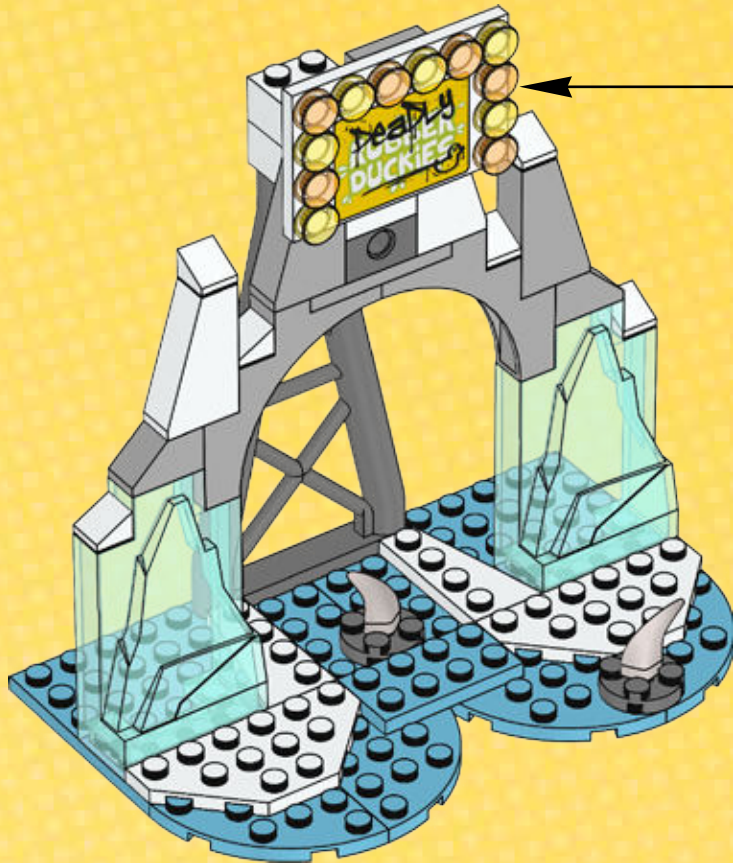
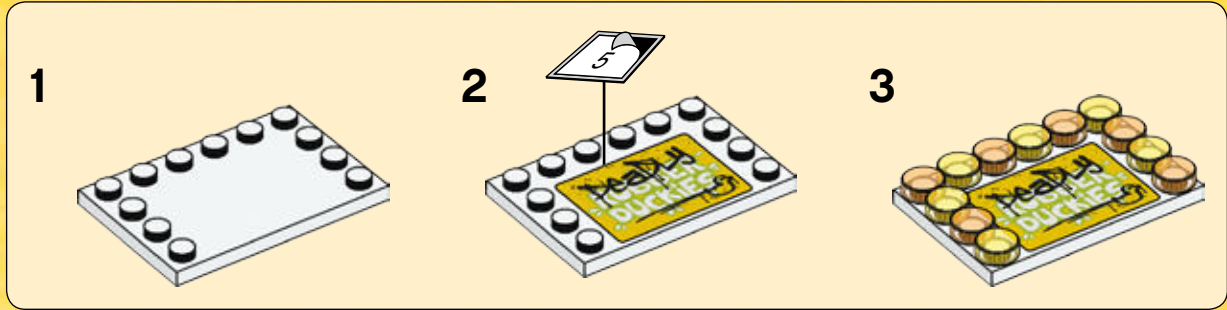

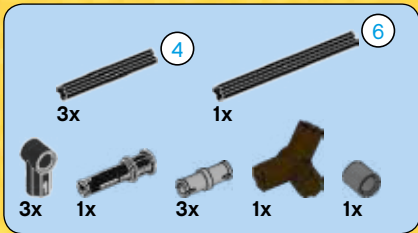

22

1

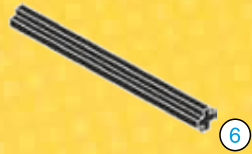

2

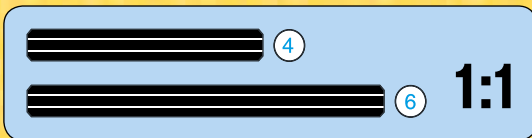

3

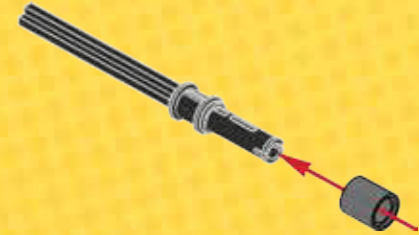

4



5

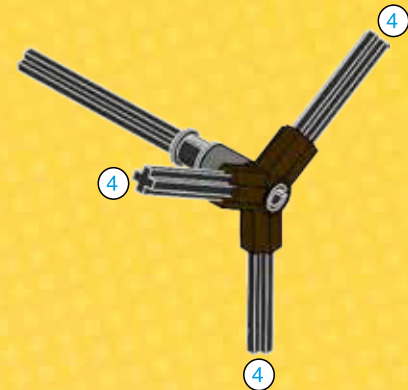

6

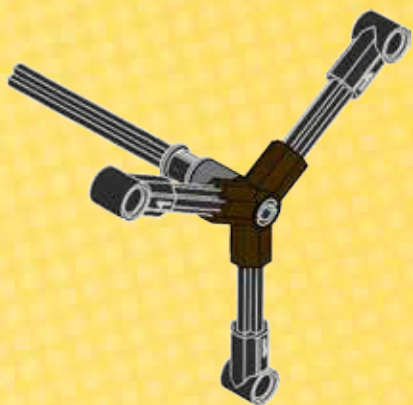

7

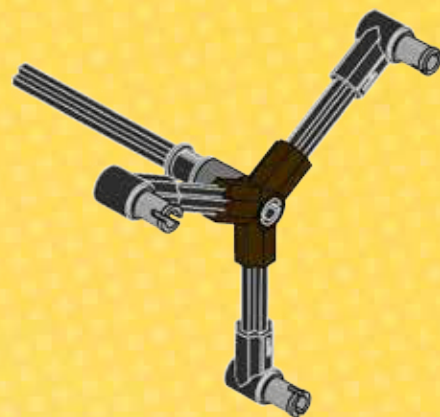



1x

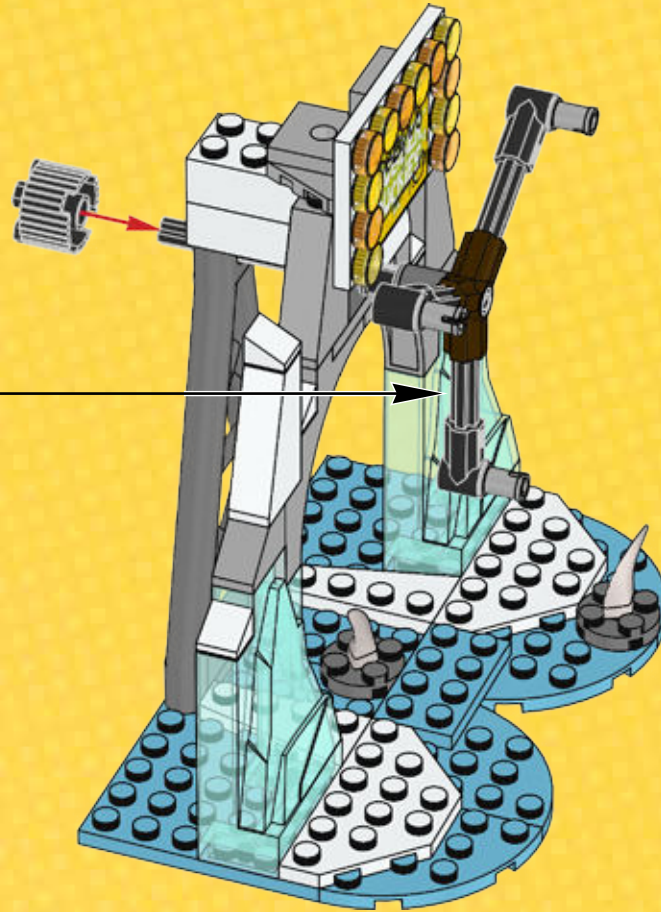

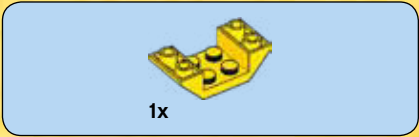

1

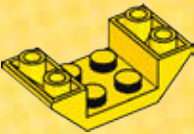

2



3

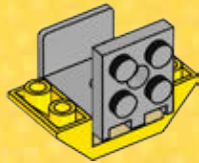

4

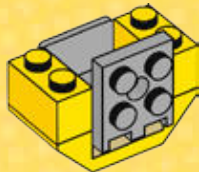





5

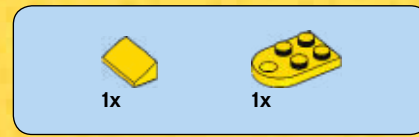
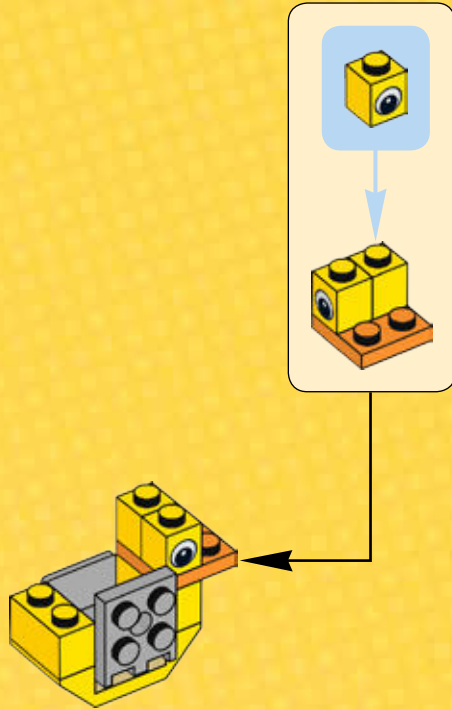

6

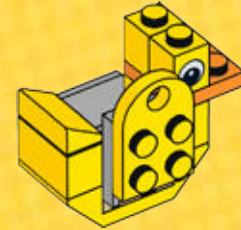

7

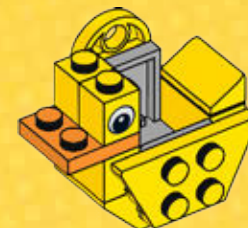
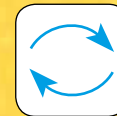

3x

23

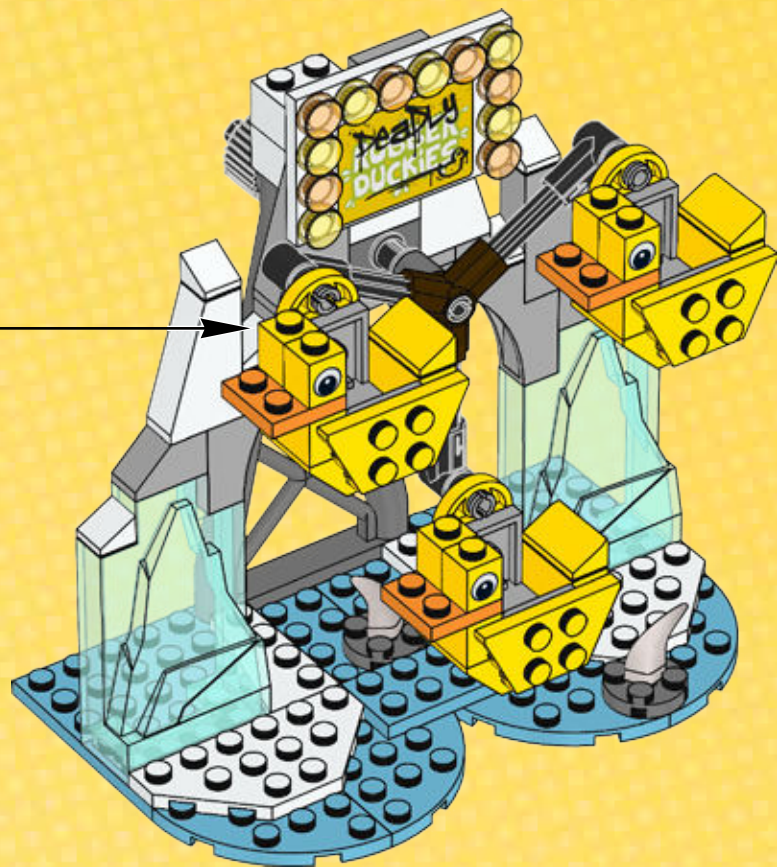



3x

# 24





1x

1



4x

1x

1x

2

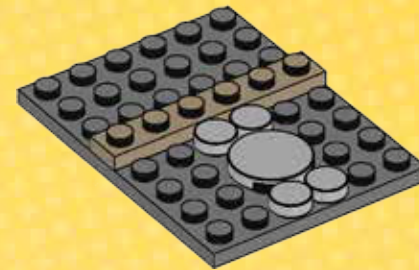



3

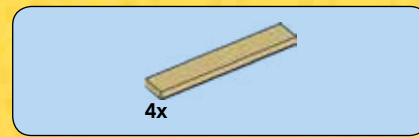
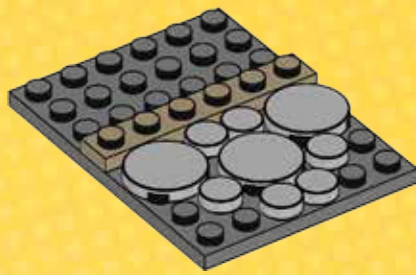

4

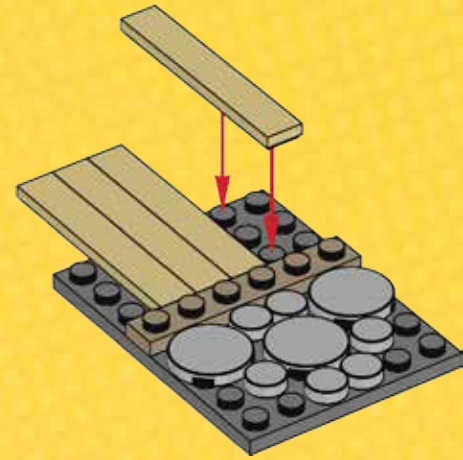



1x

5

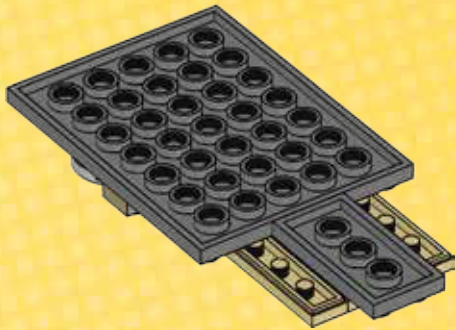

2x

6

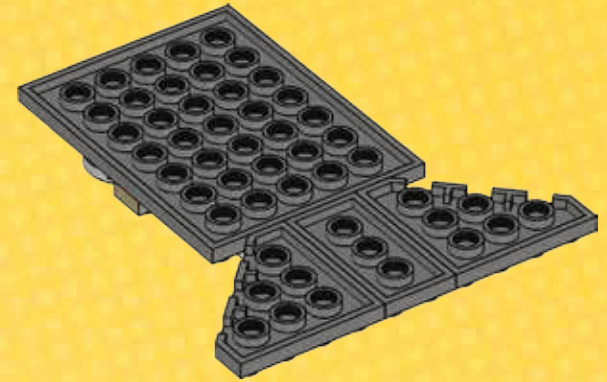

3x

7

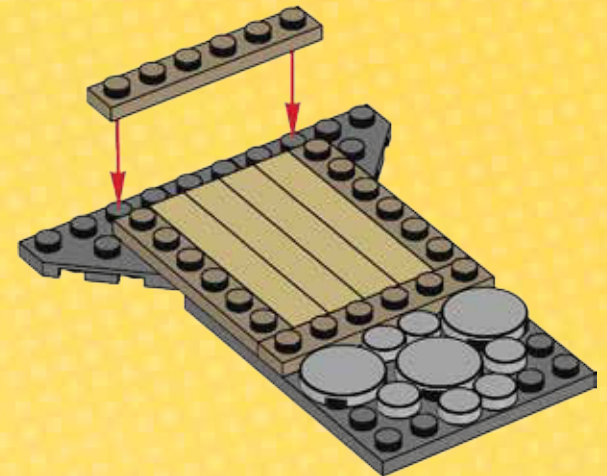
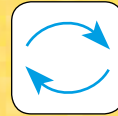

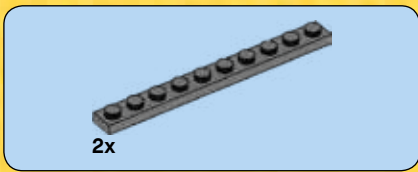

8

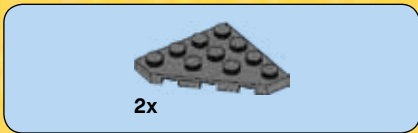
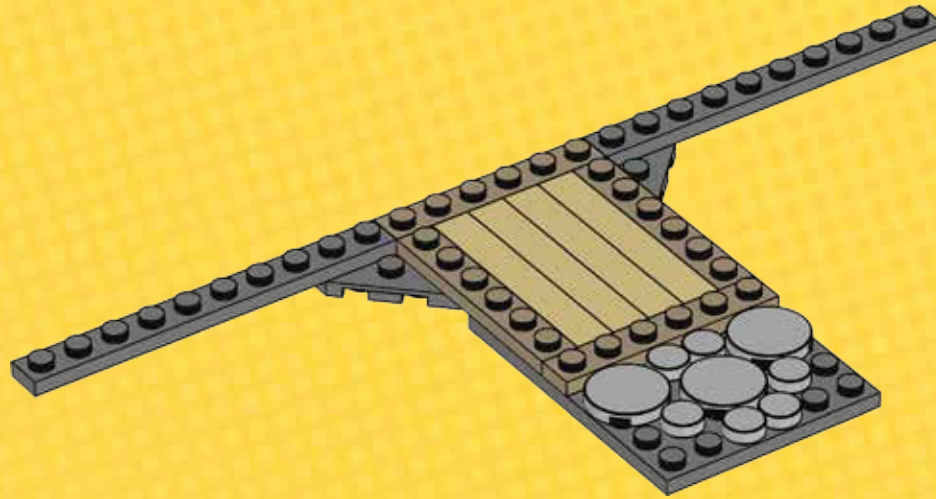

9

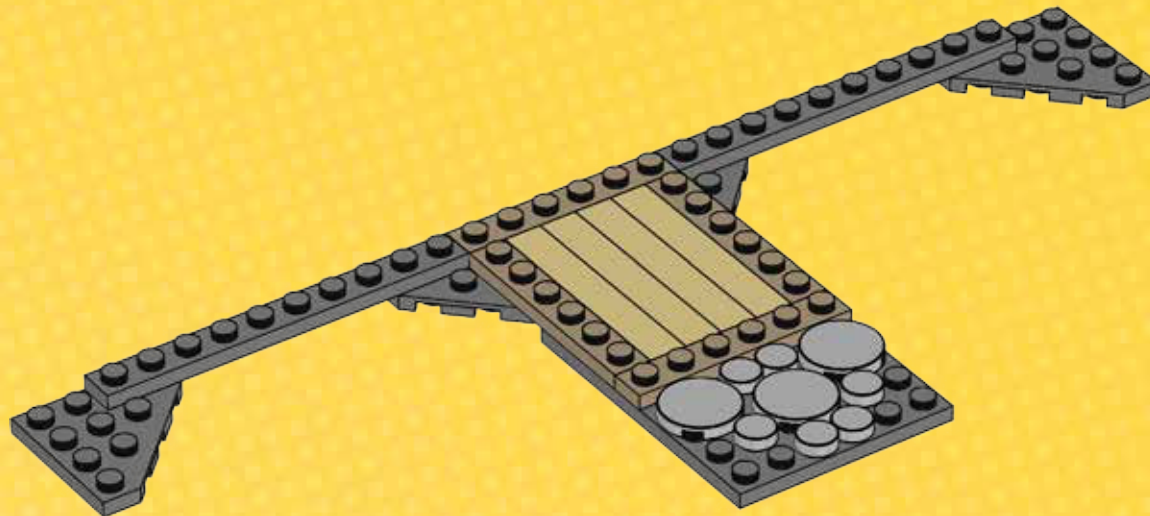



4x

# 10

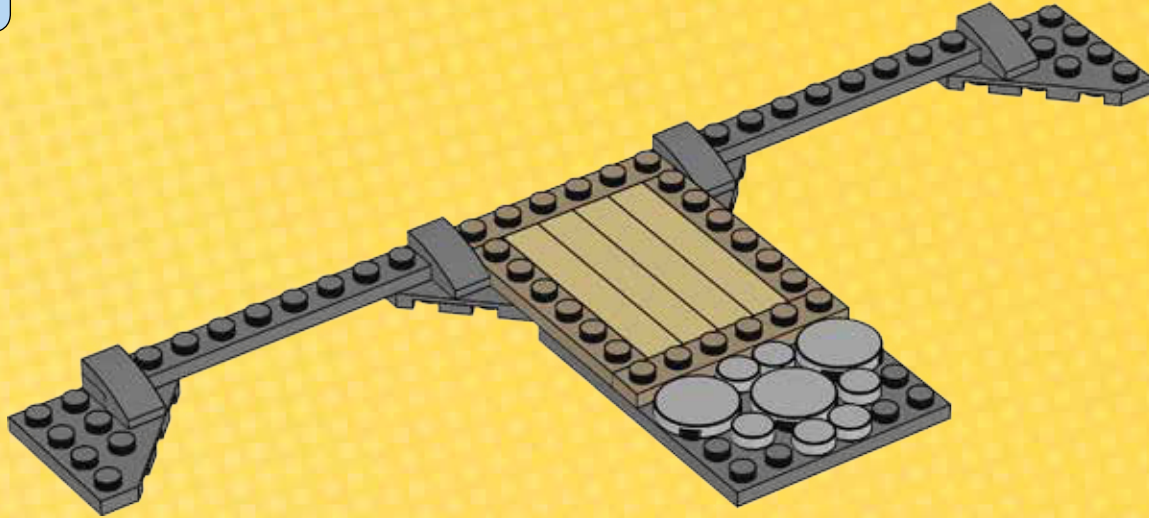

2x



2x



2x

# 11

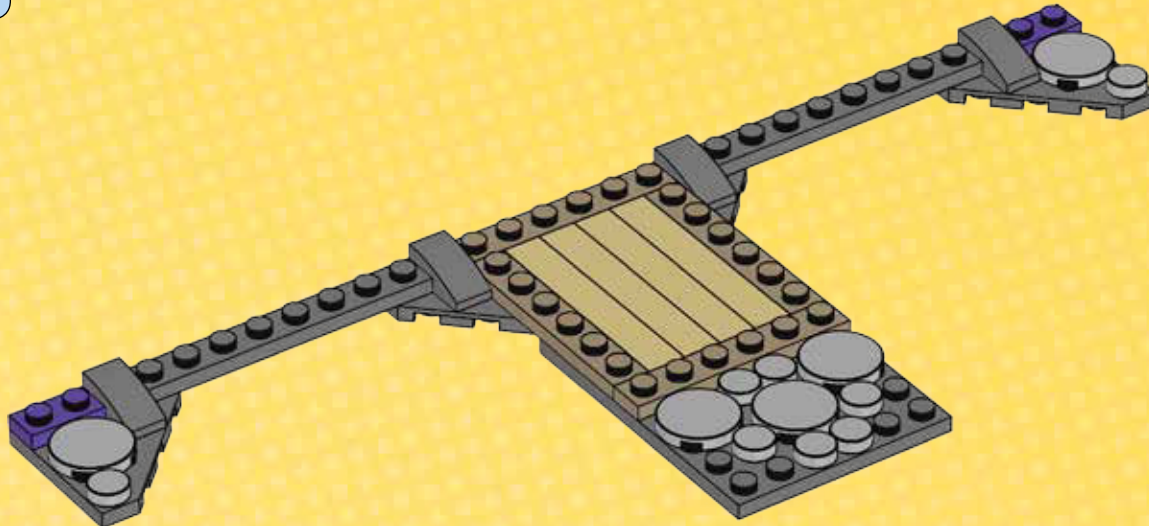





6x

# 12

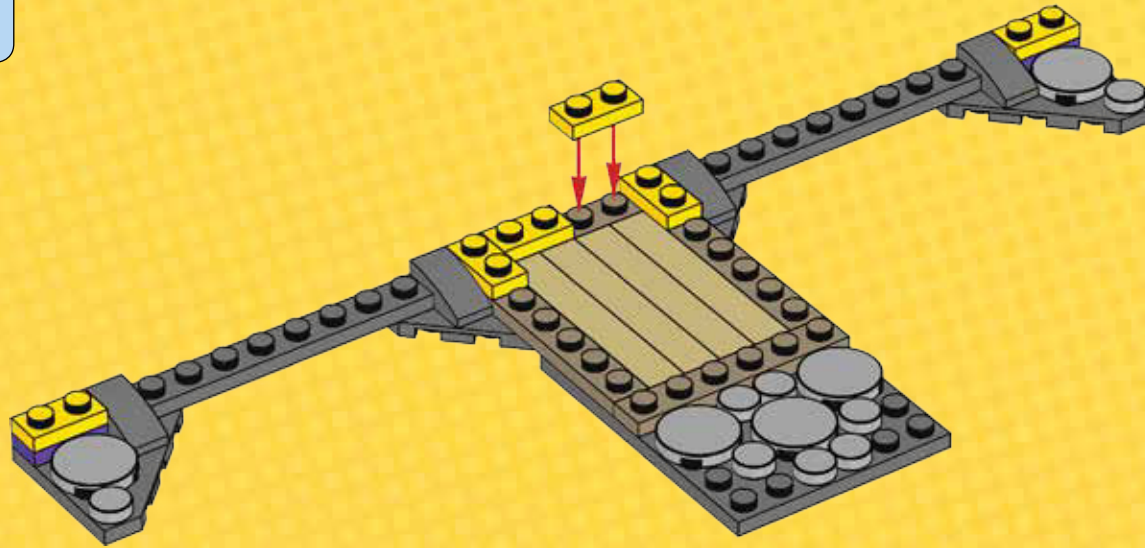

2x



3x

# 13

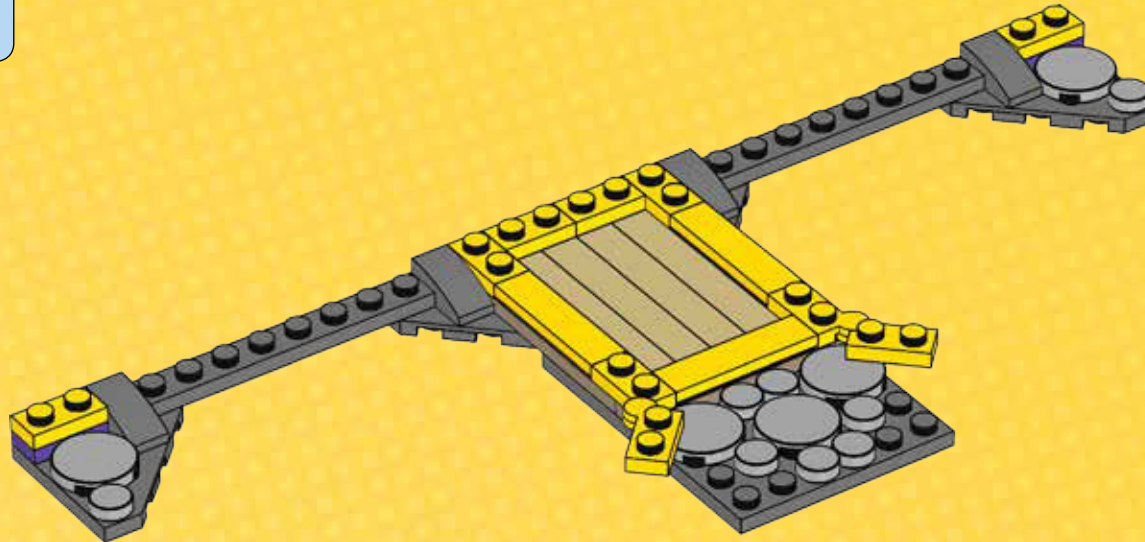

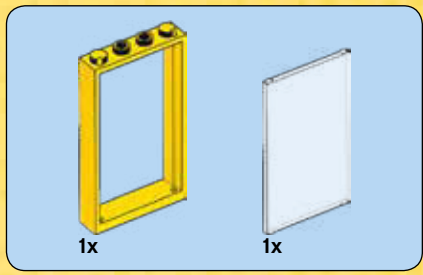

14

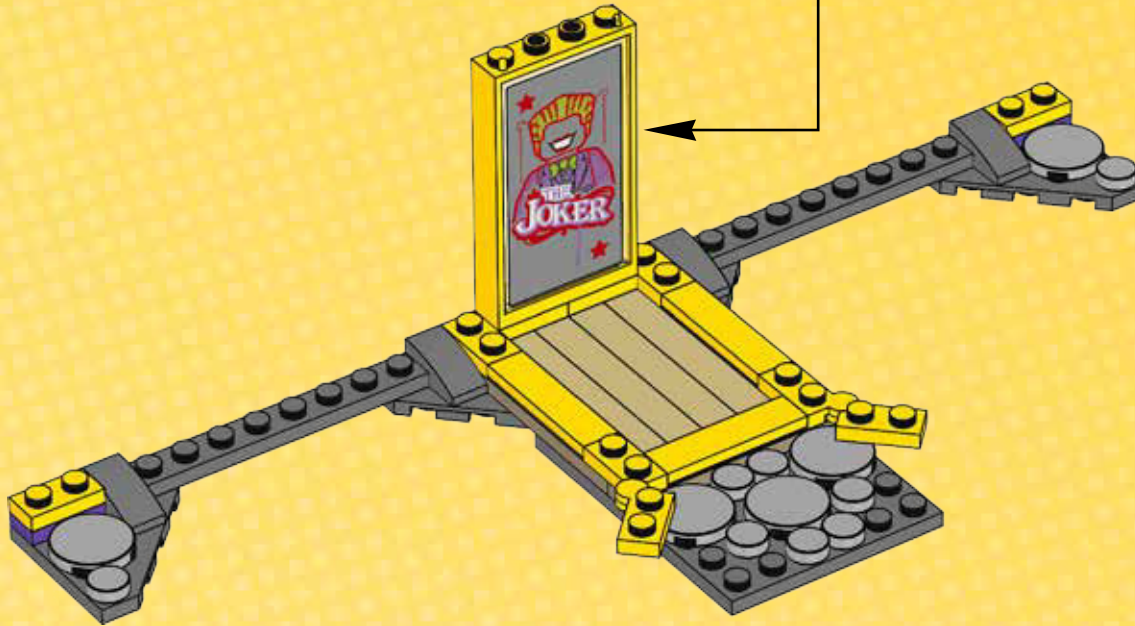
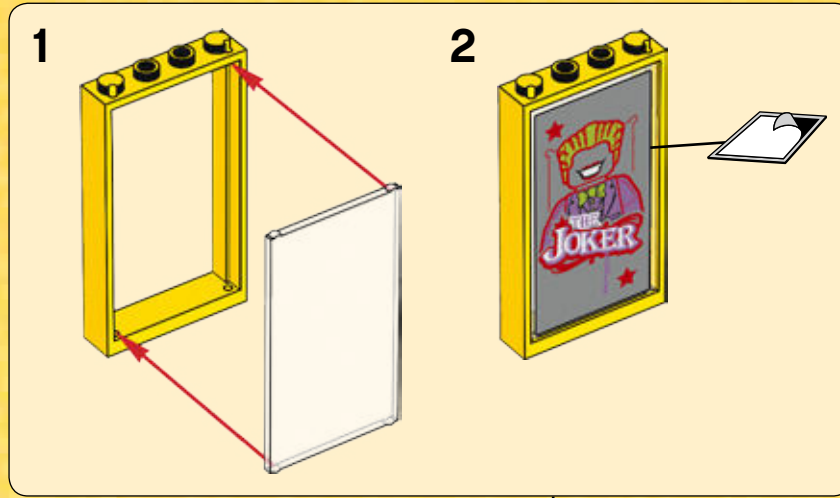



15

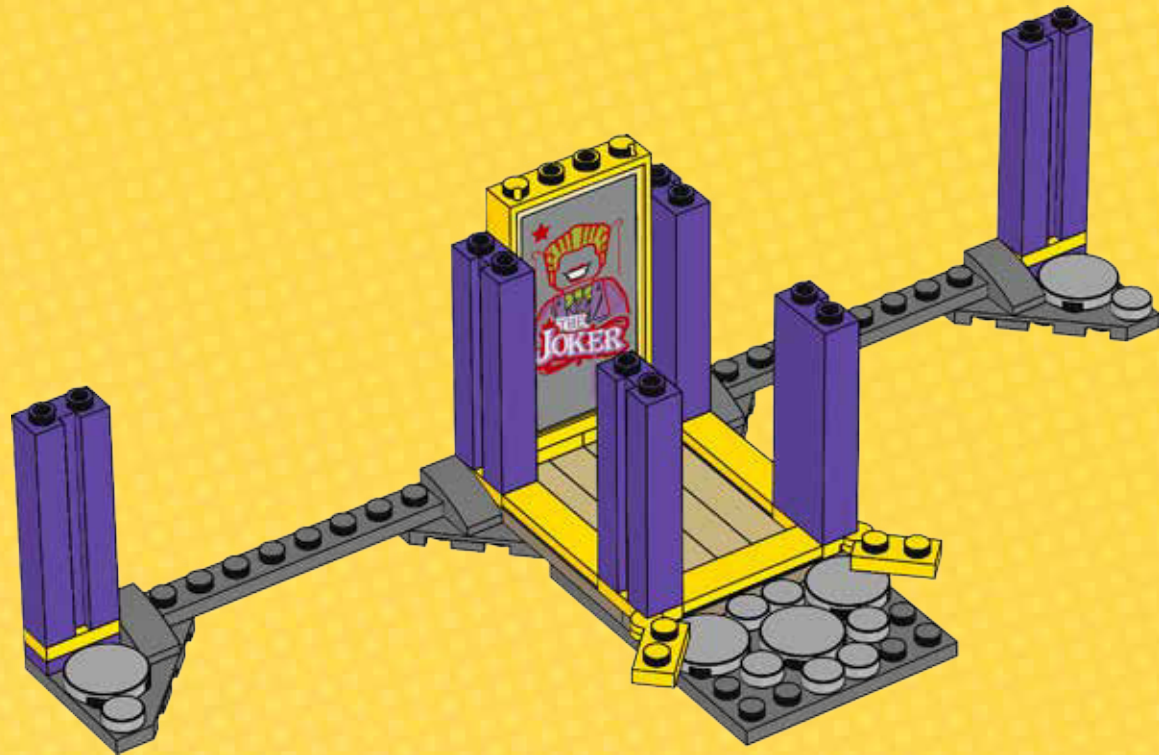

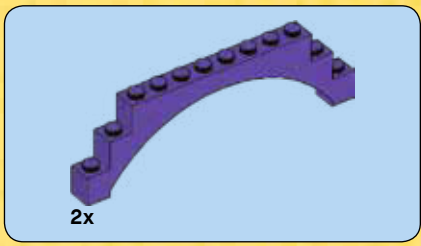

16

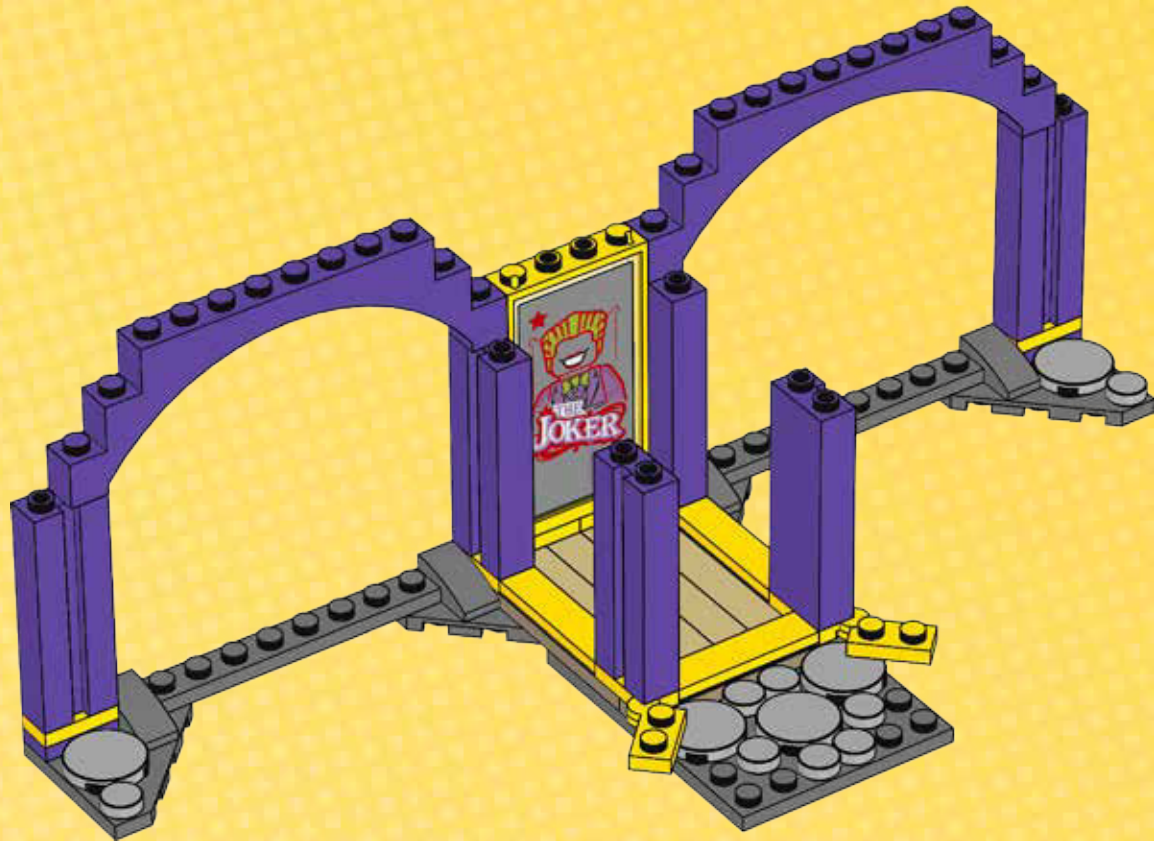

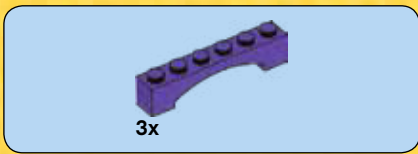

17

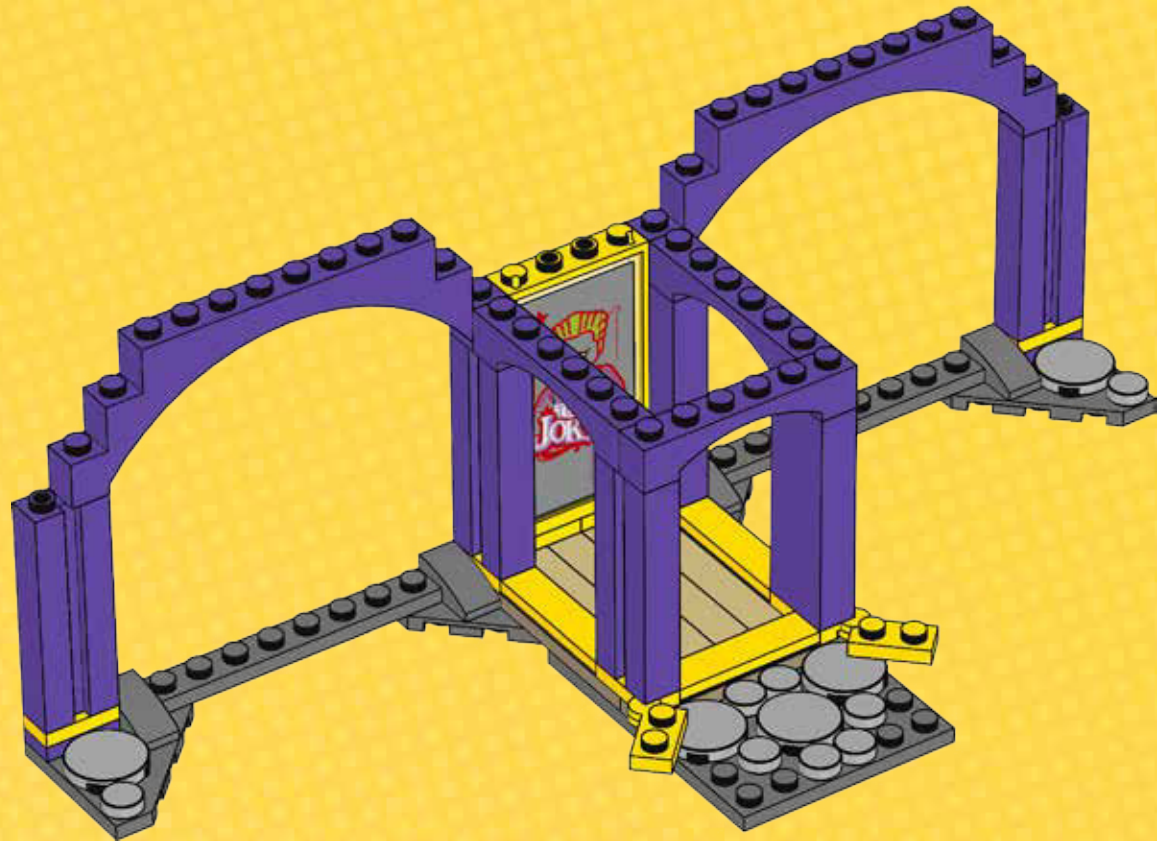

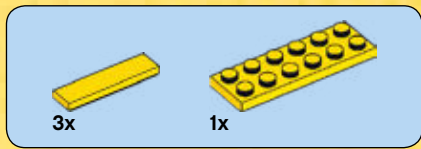

18

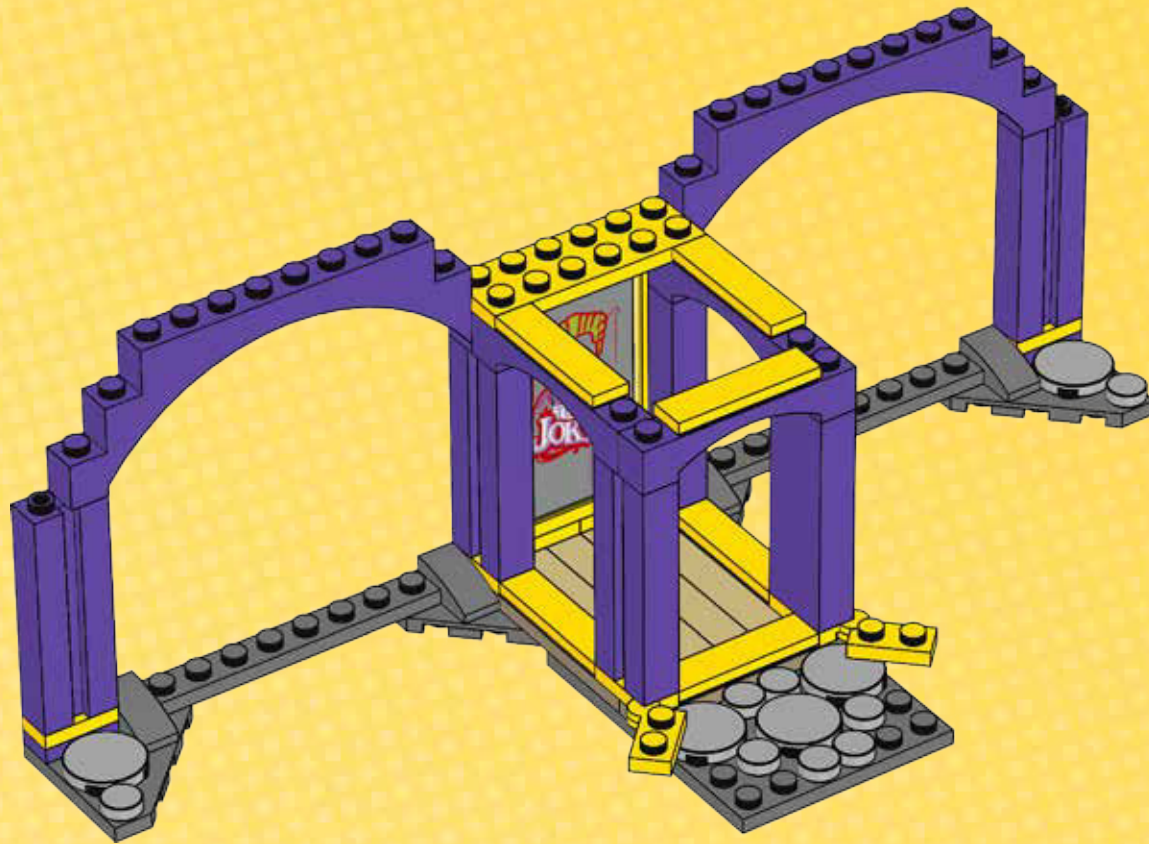

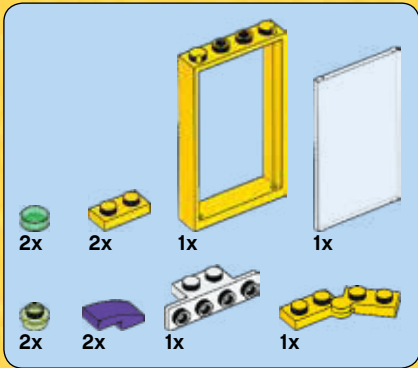

# 19

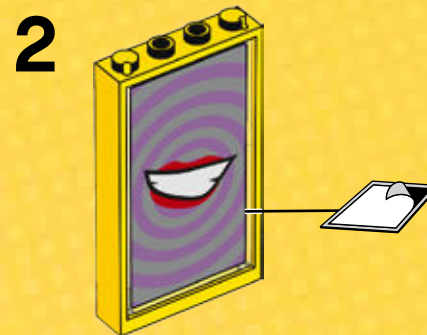
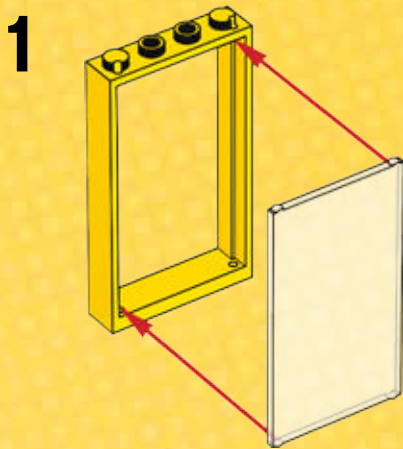

4



5



6





7

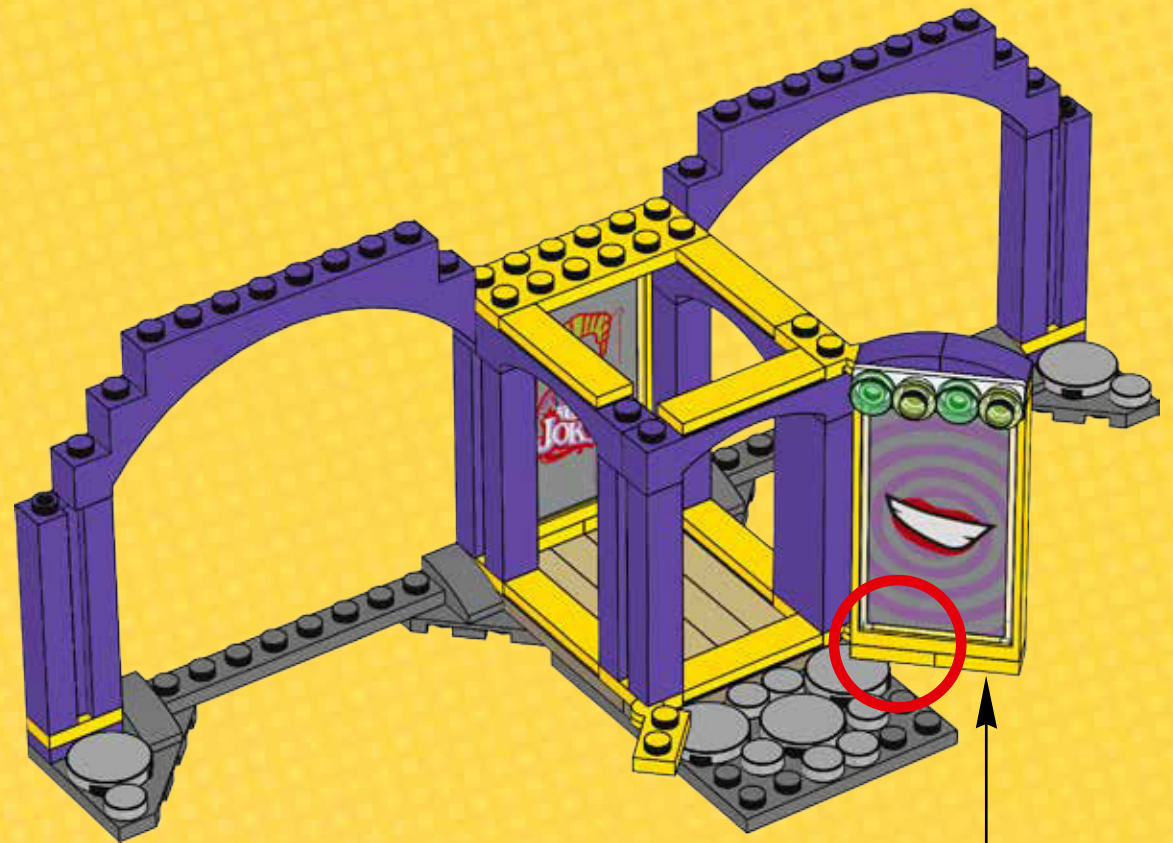

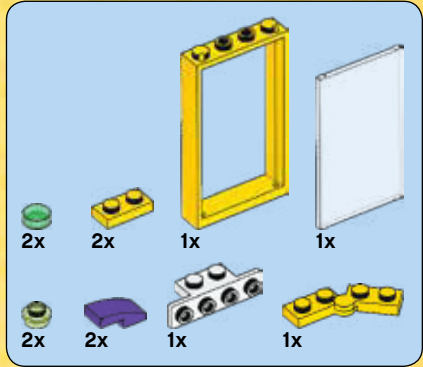

# 20

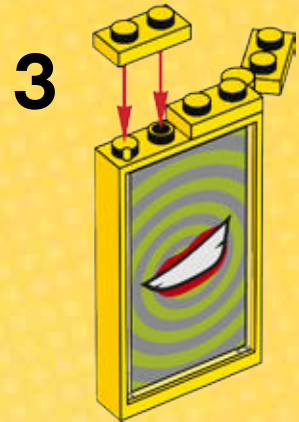
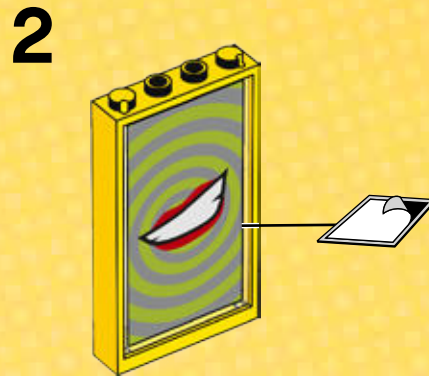
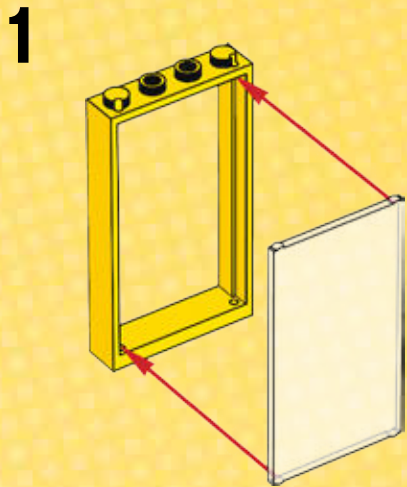



7



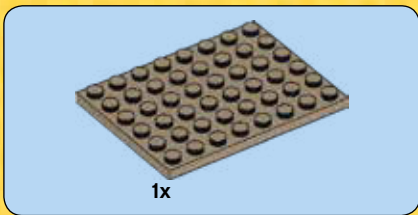

21





4x

22



4x

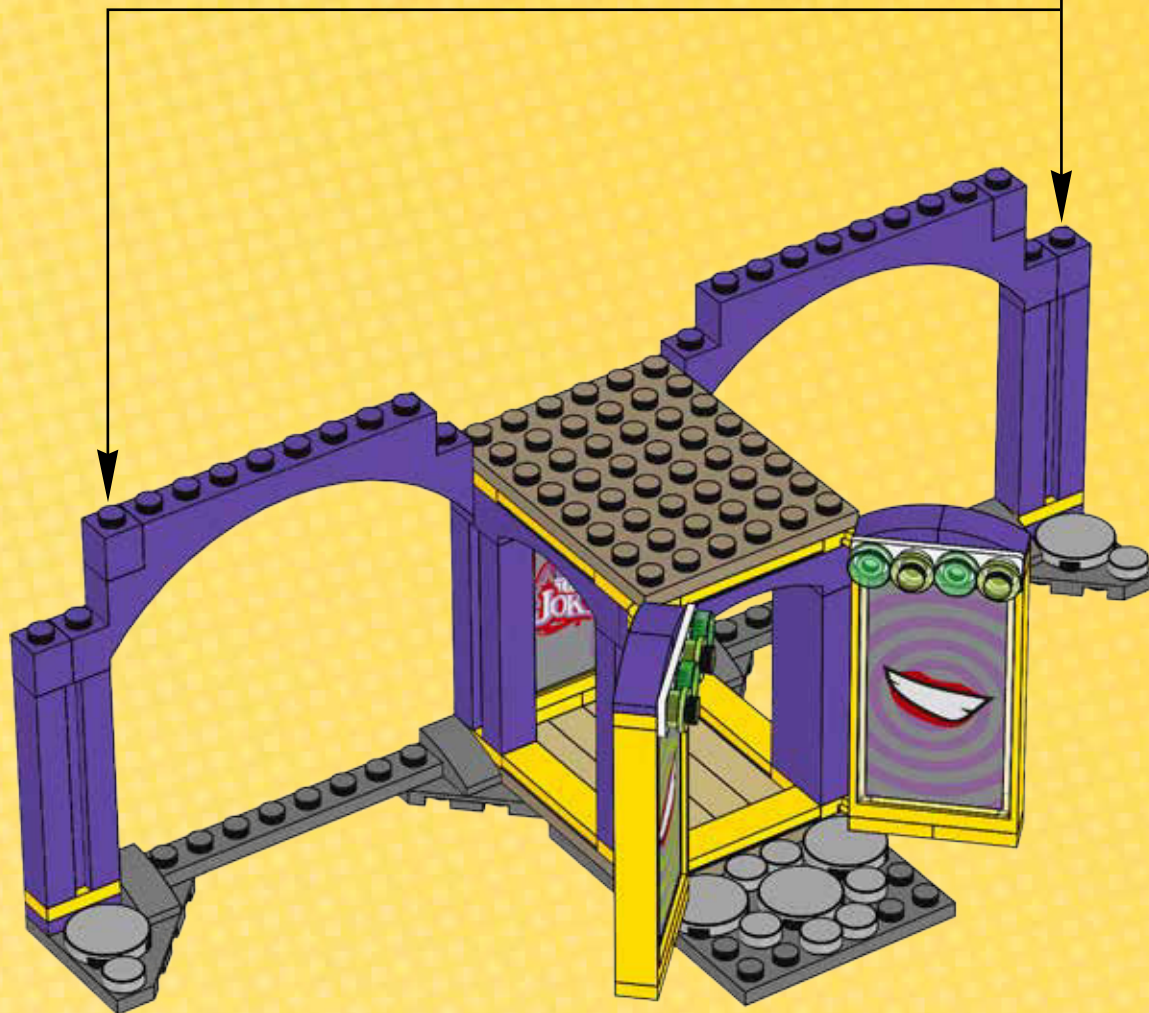



2x

# 23

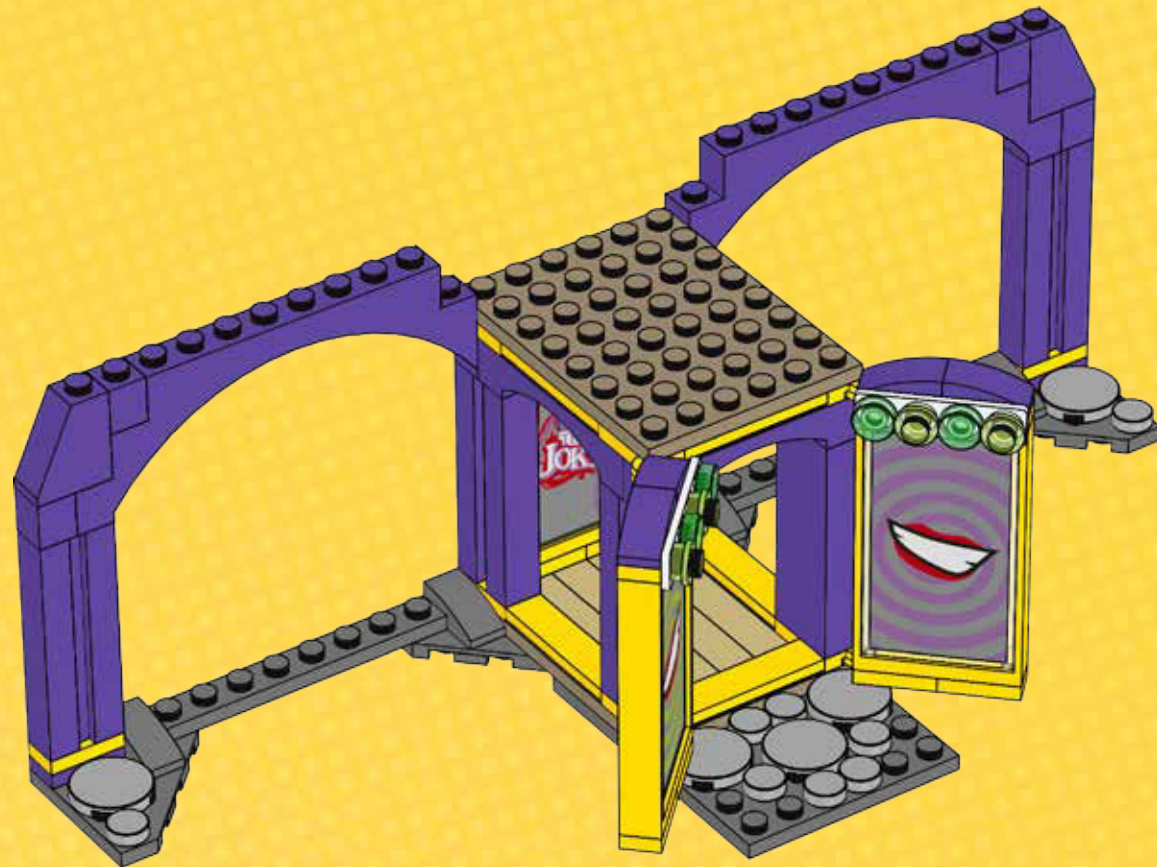



2x



4x

# 24







7x

# 25

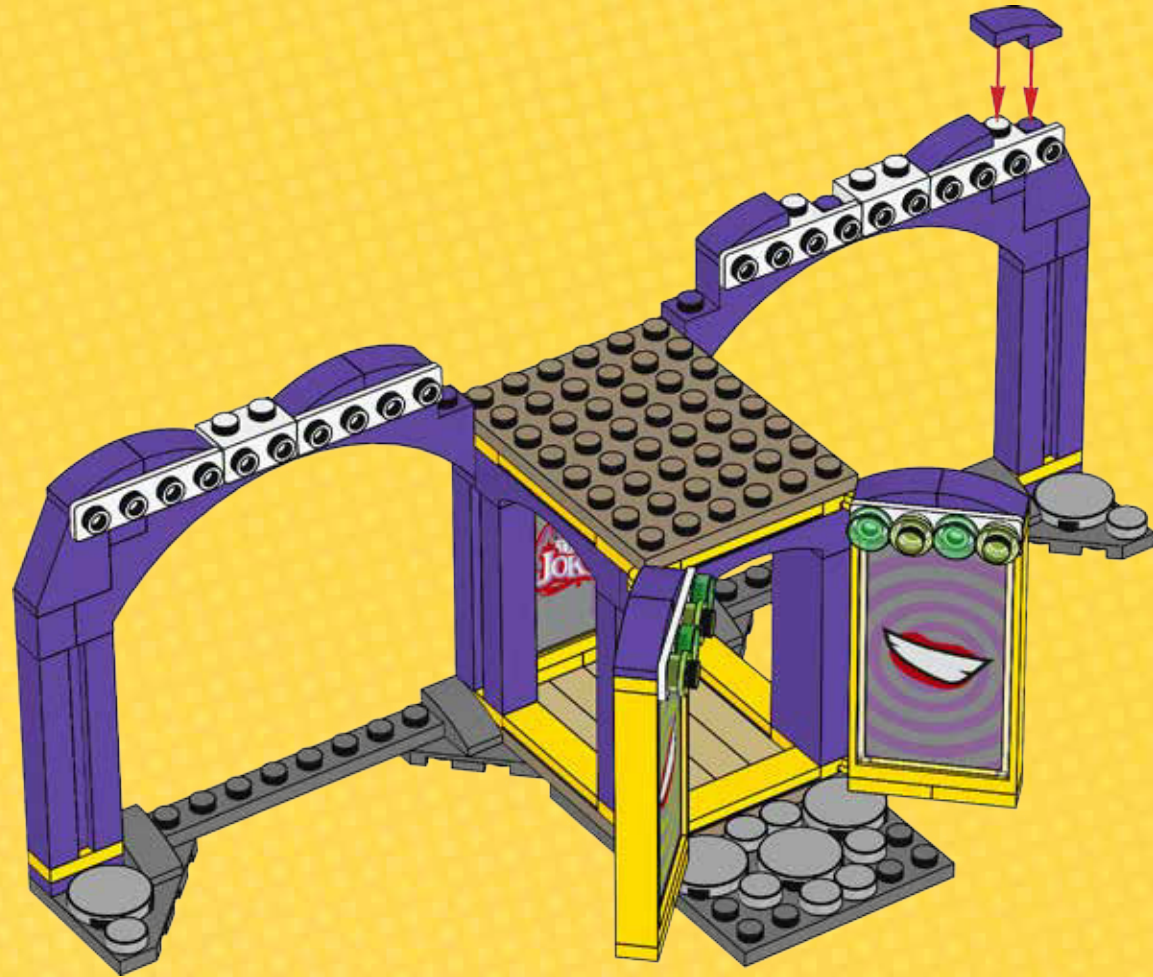



10x



10x

# 26



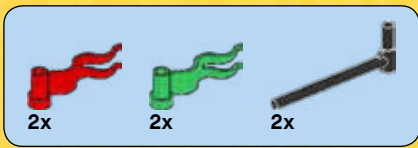

27

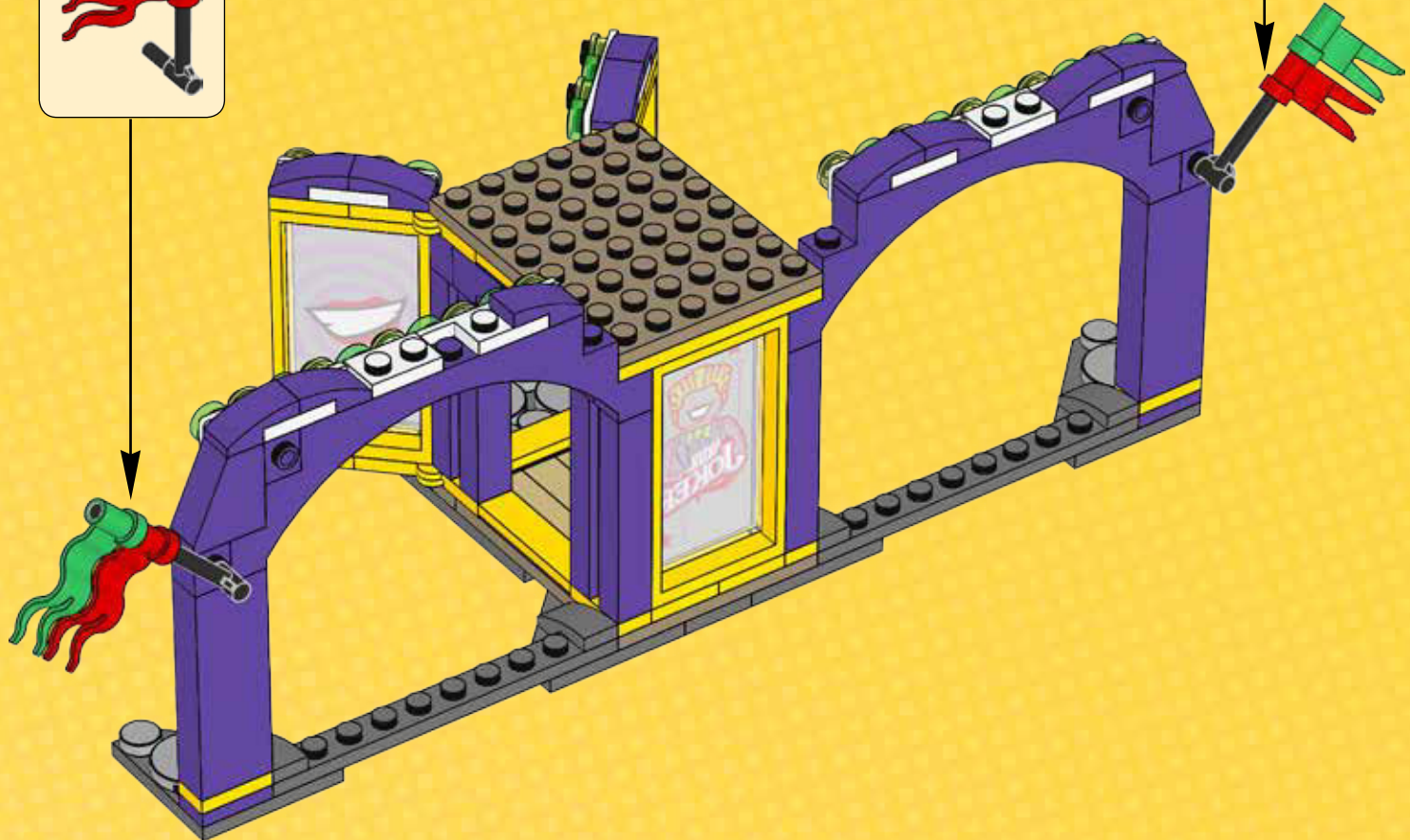
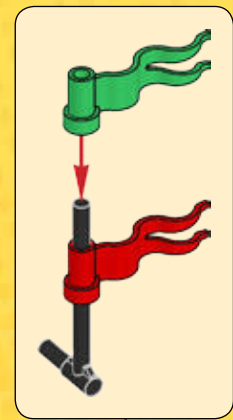
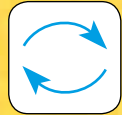
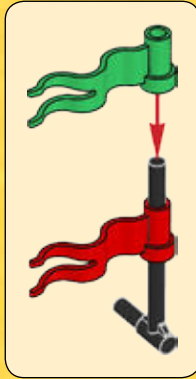



28

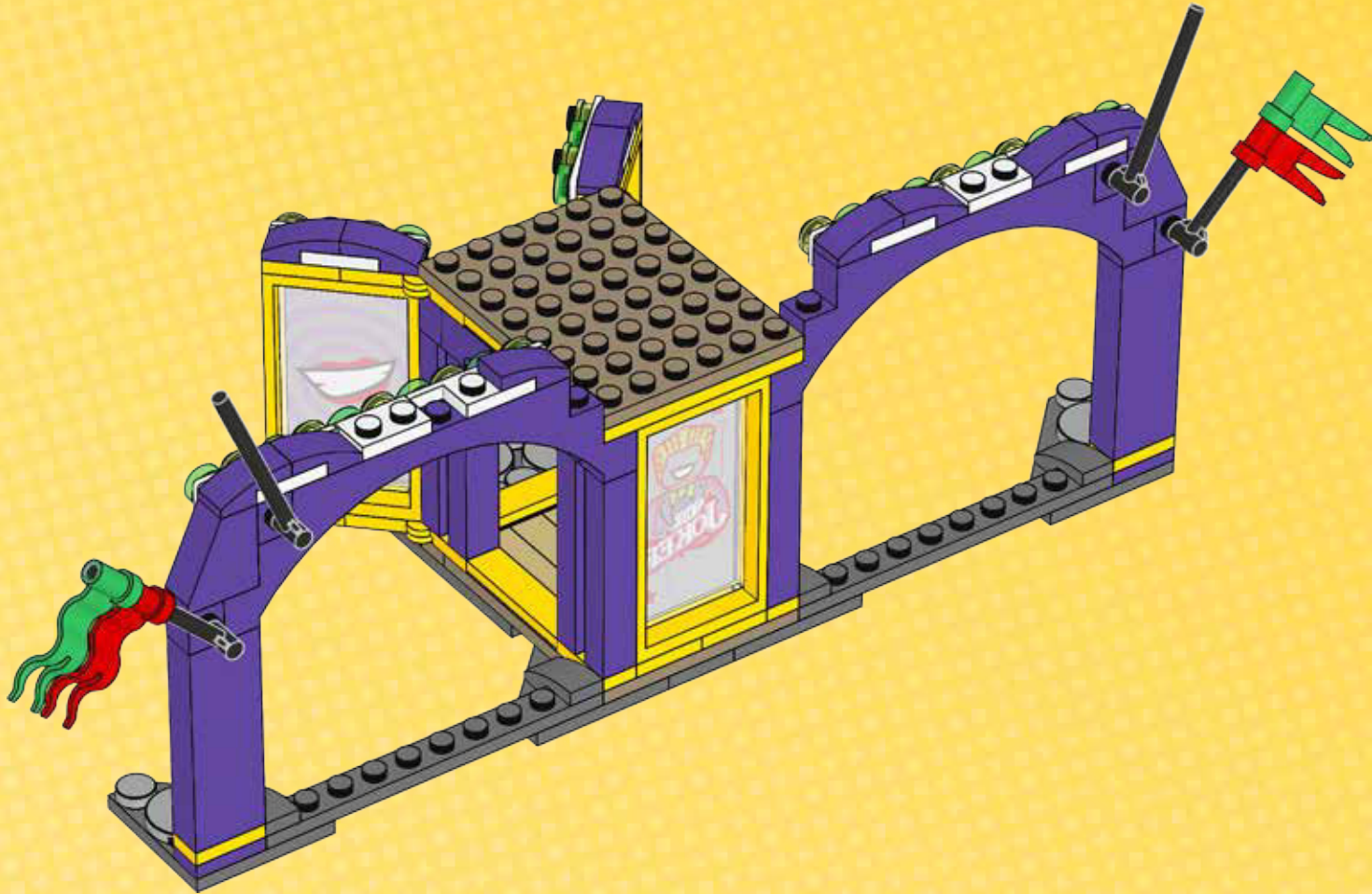

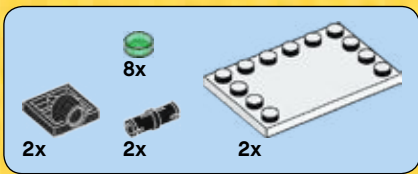

29

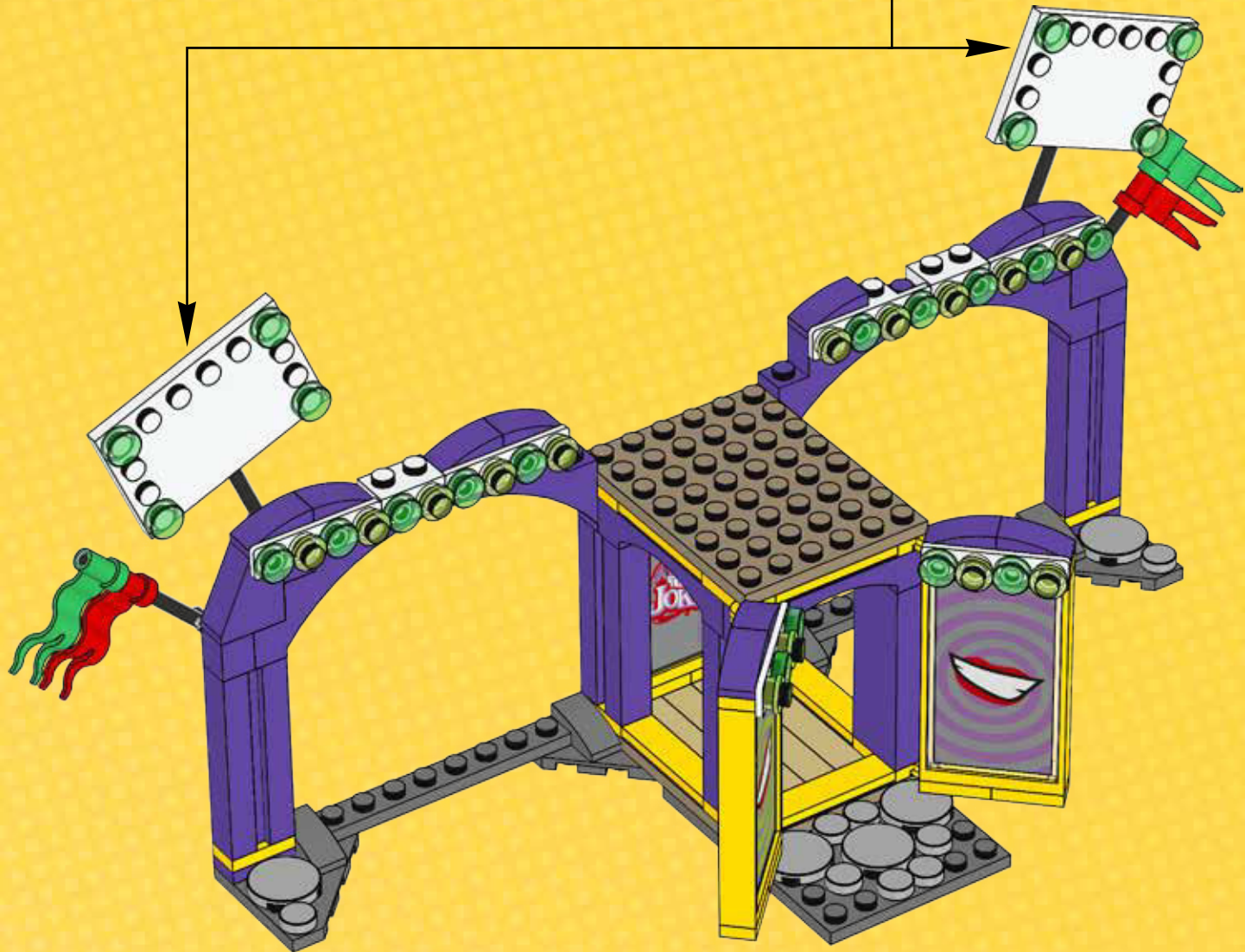
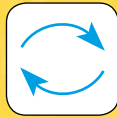
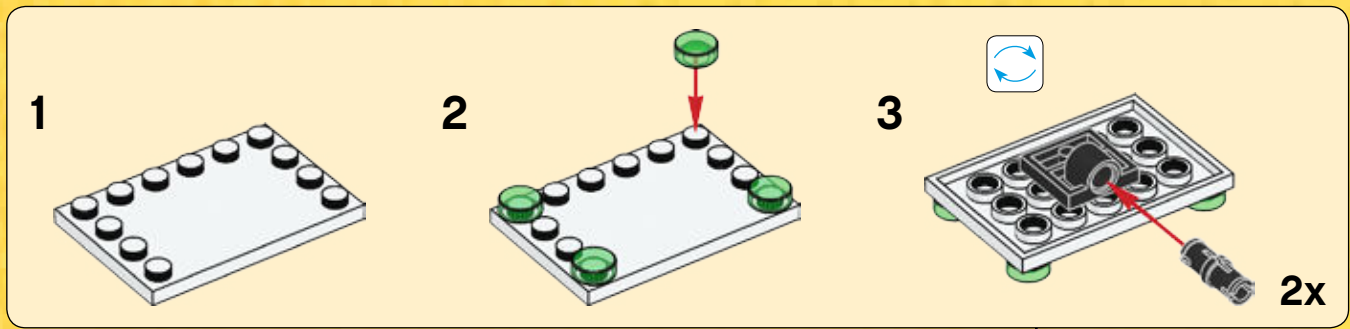

30

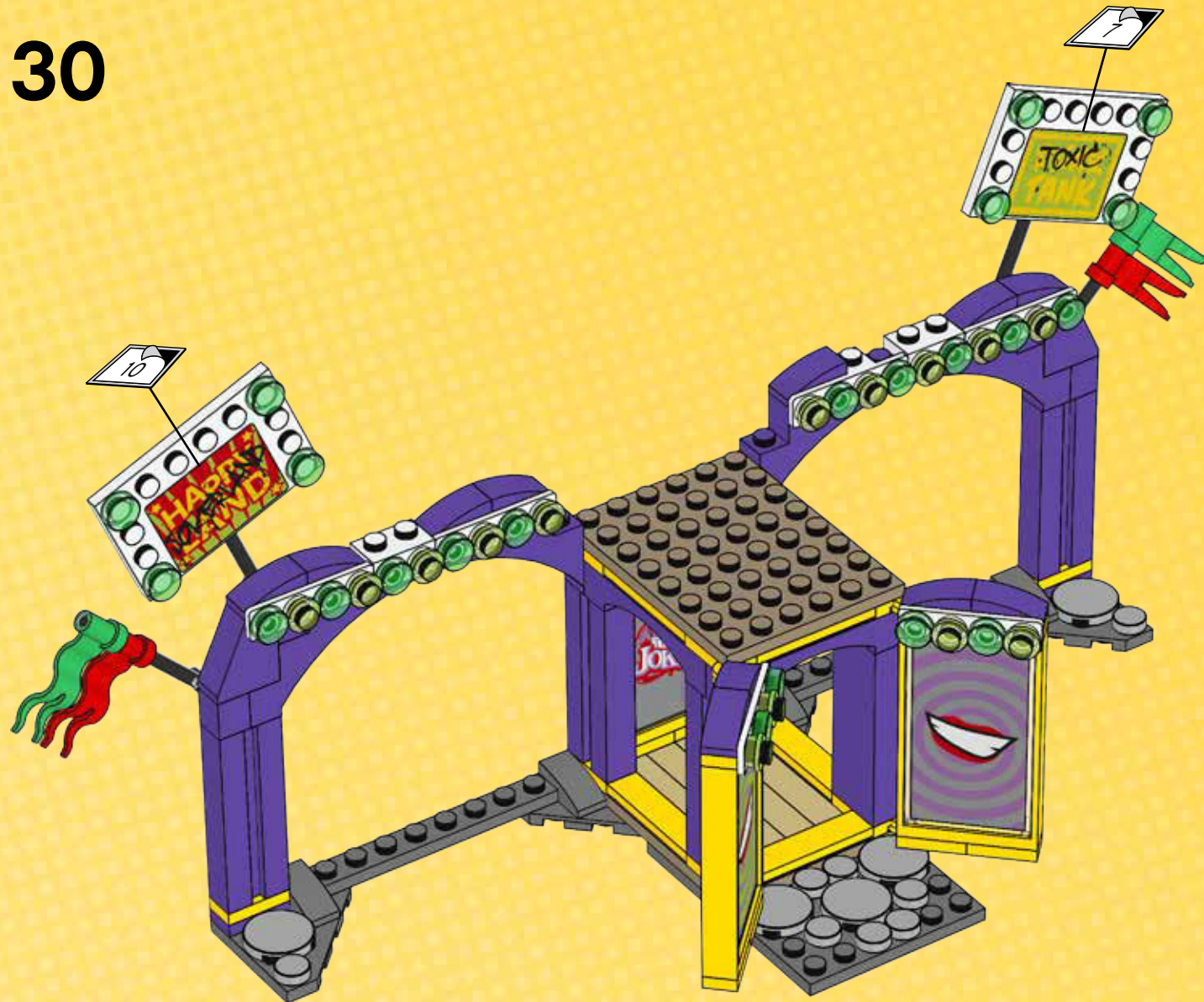

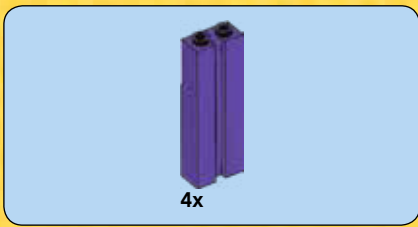

31





4x

# 32







2x

# 33





2x

# 34



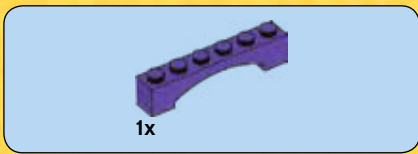

35



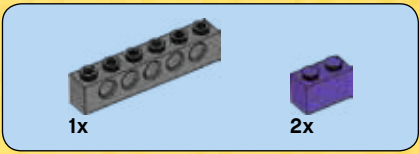

# 36



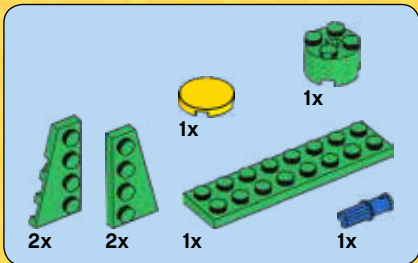
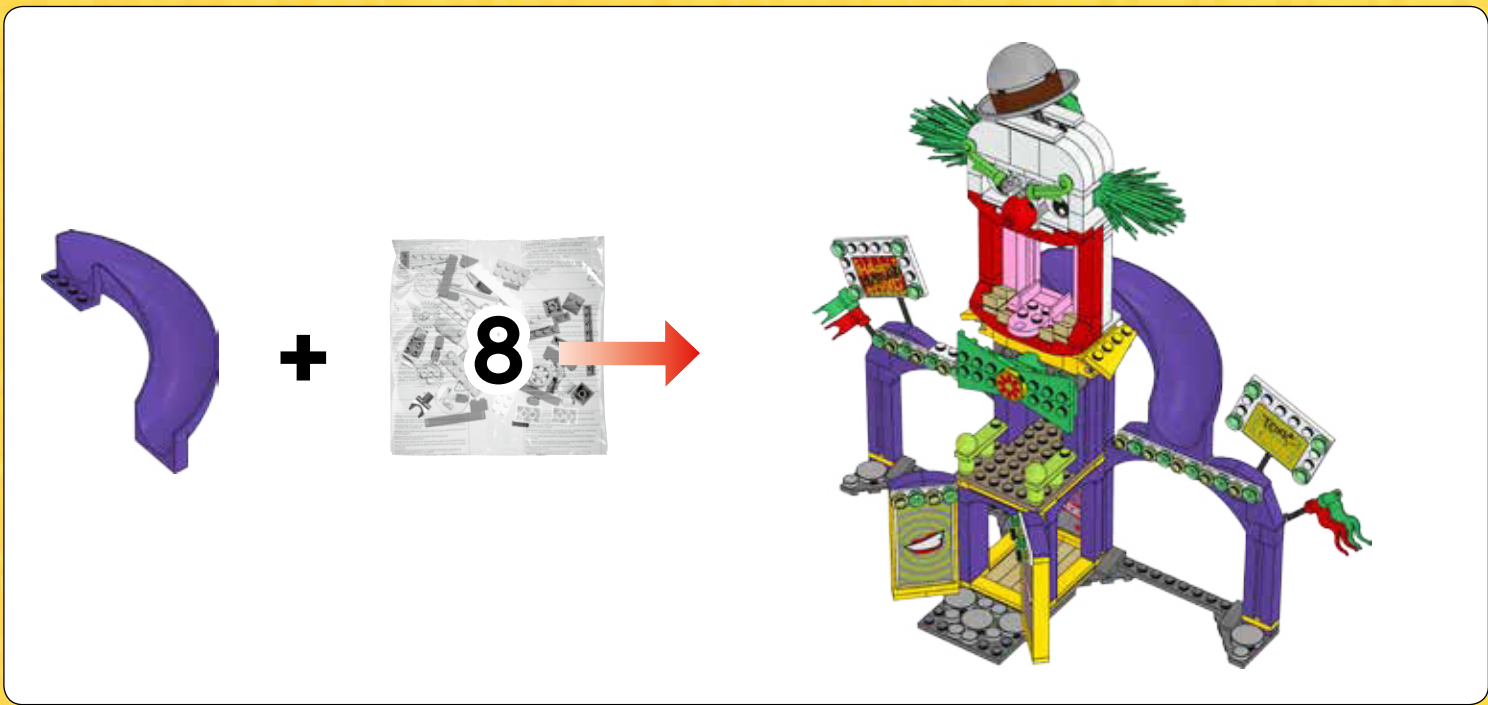

**37**

**1**

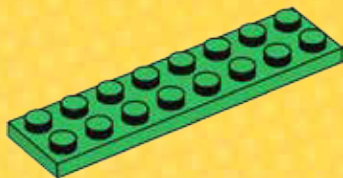

**2**

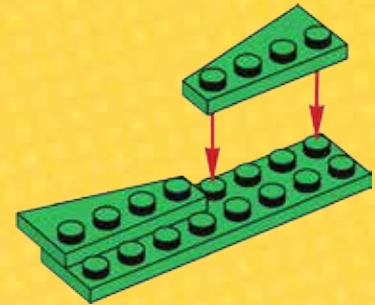

3

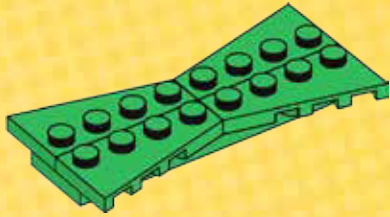

5

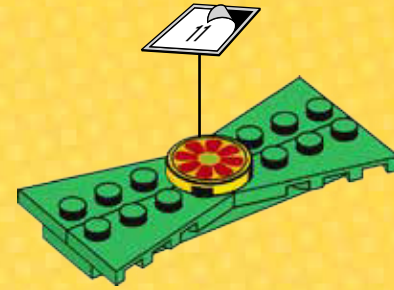

4

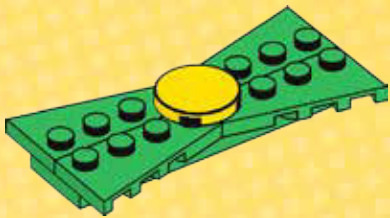

6

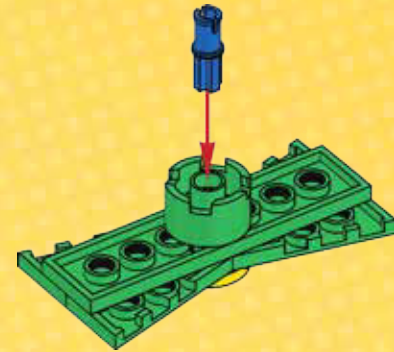



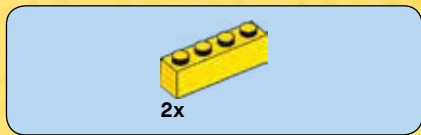

38





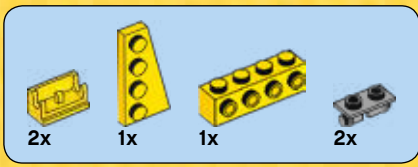

39

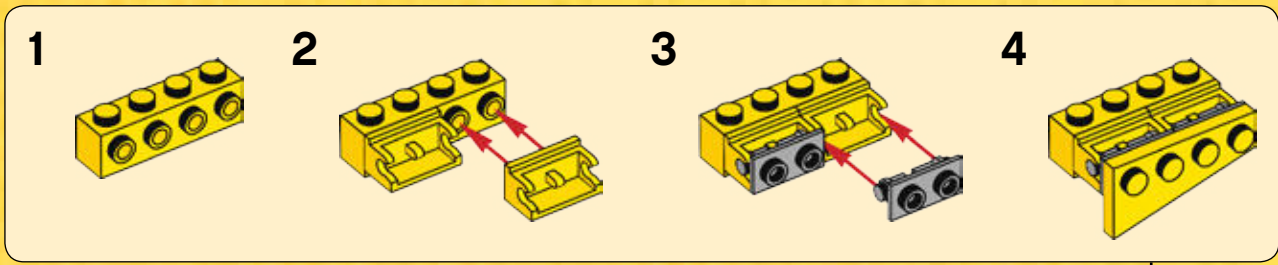

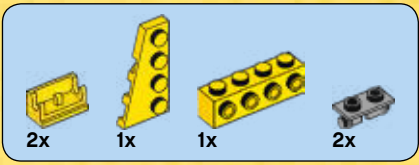

40

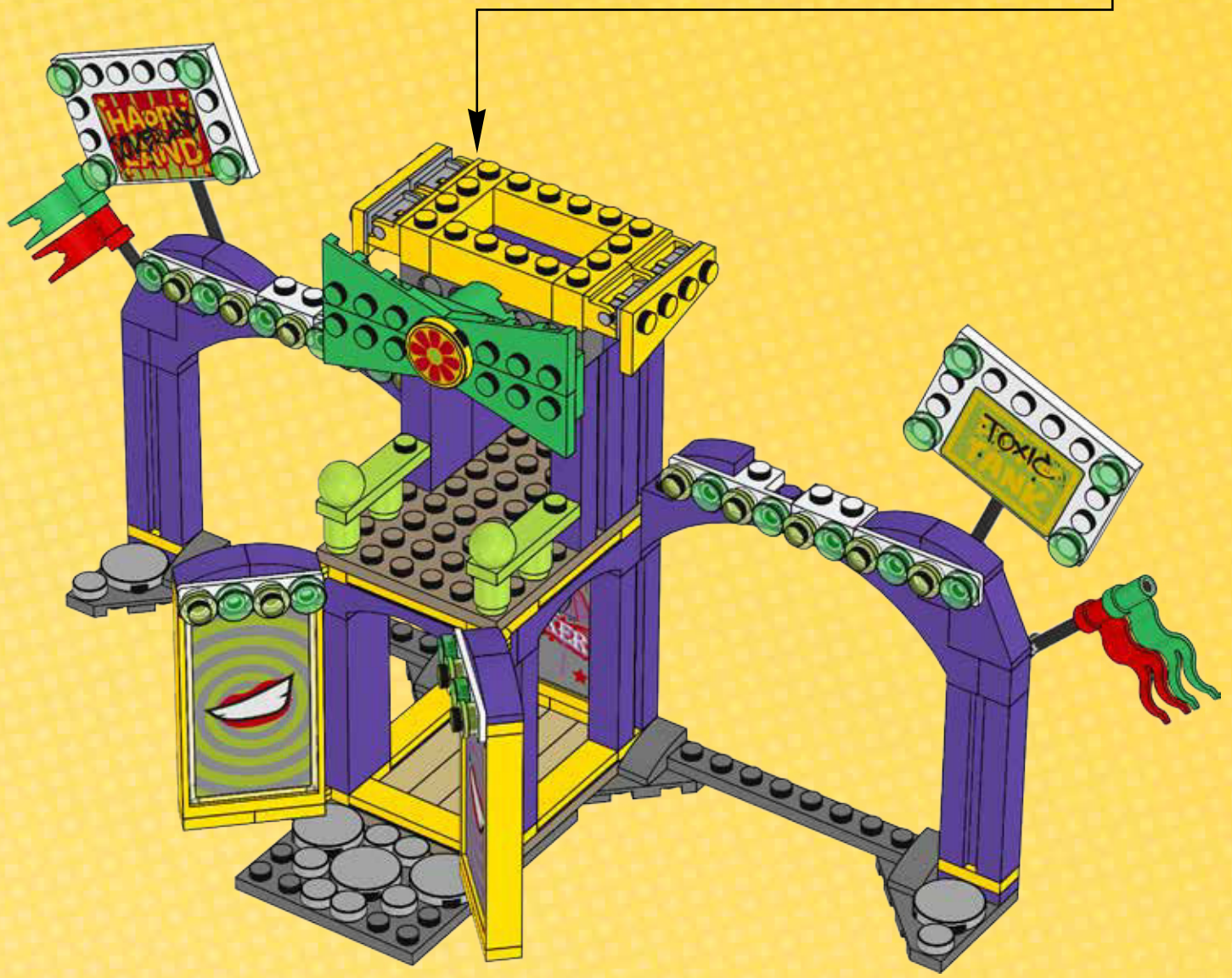
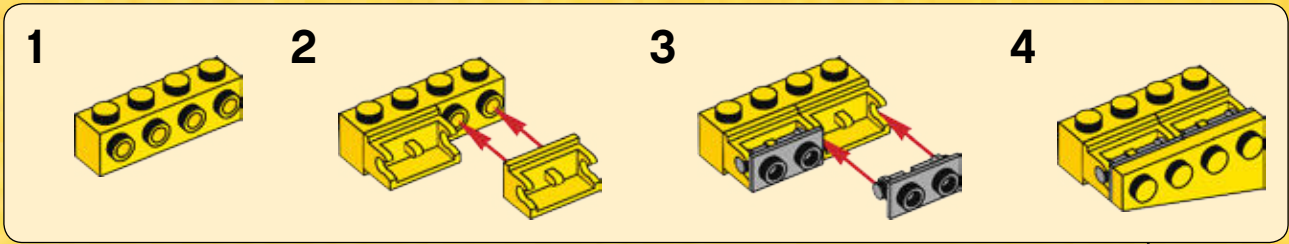

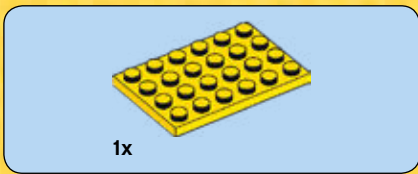

41





2x

# 42





43





1x

44

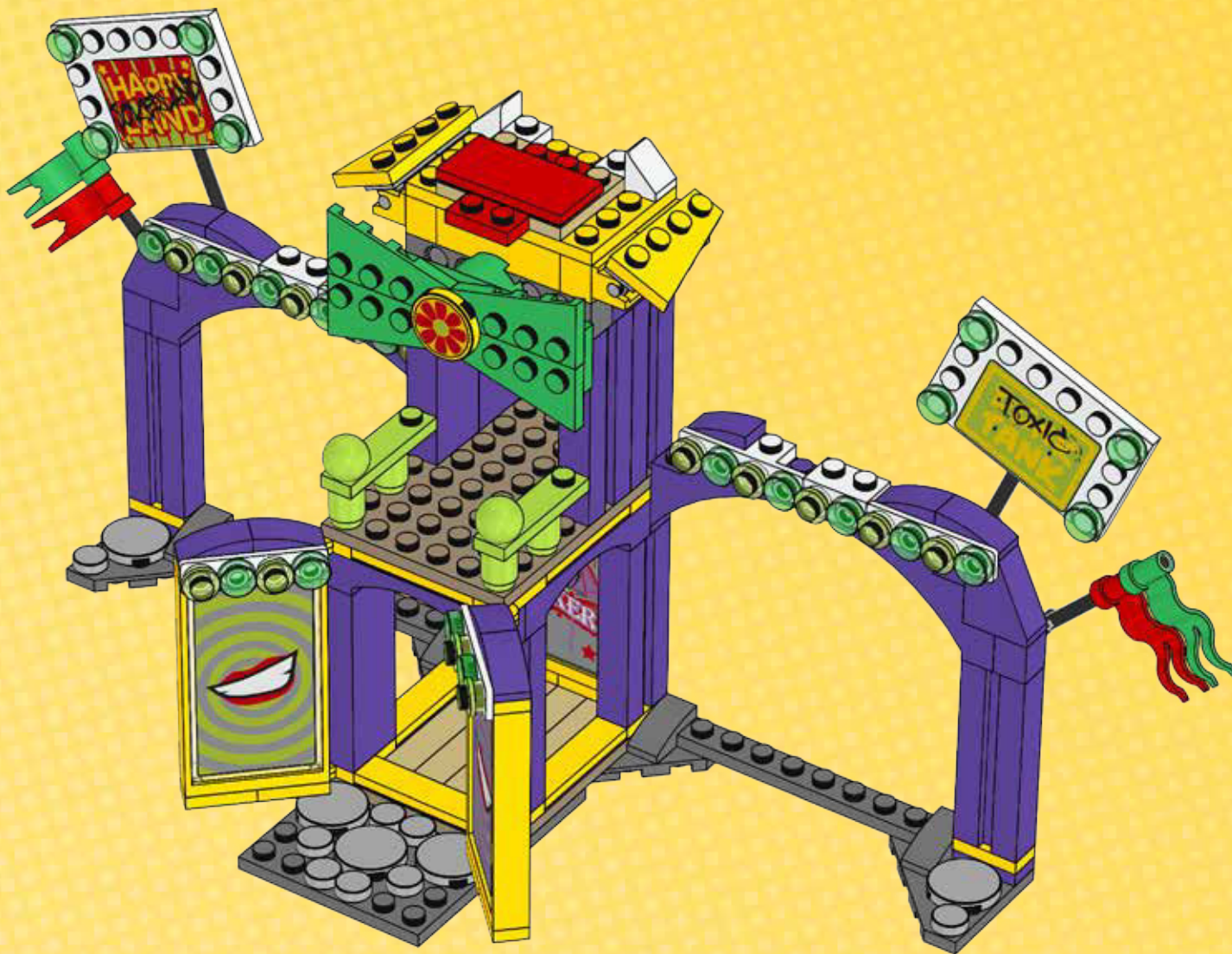

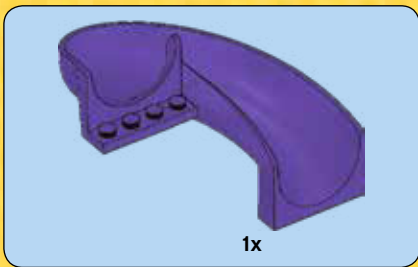

45





2x



2x

# 46







47





2x



2x

# 48

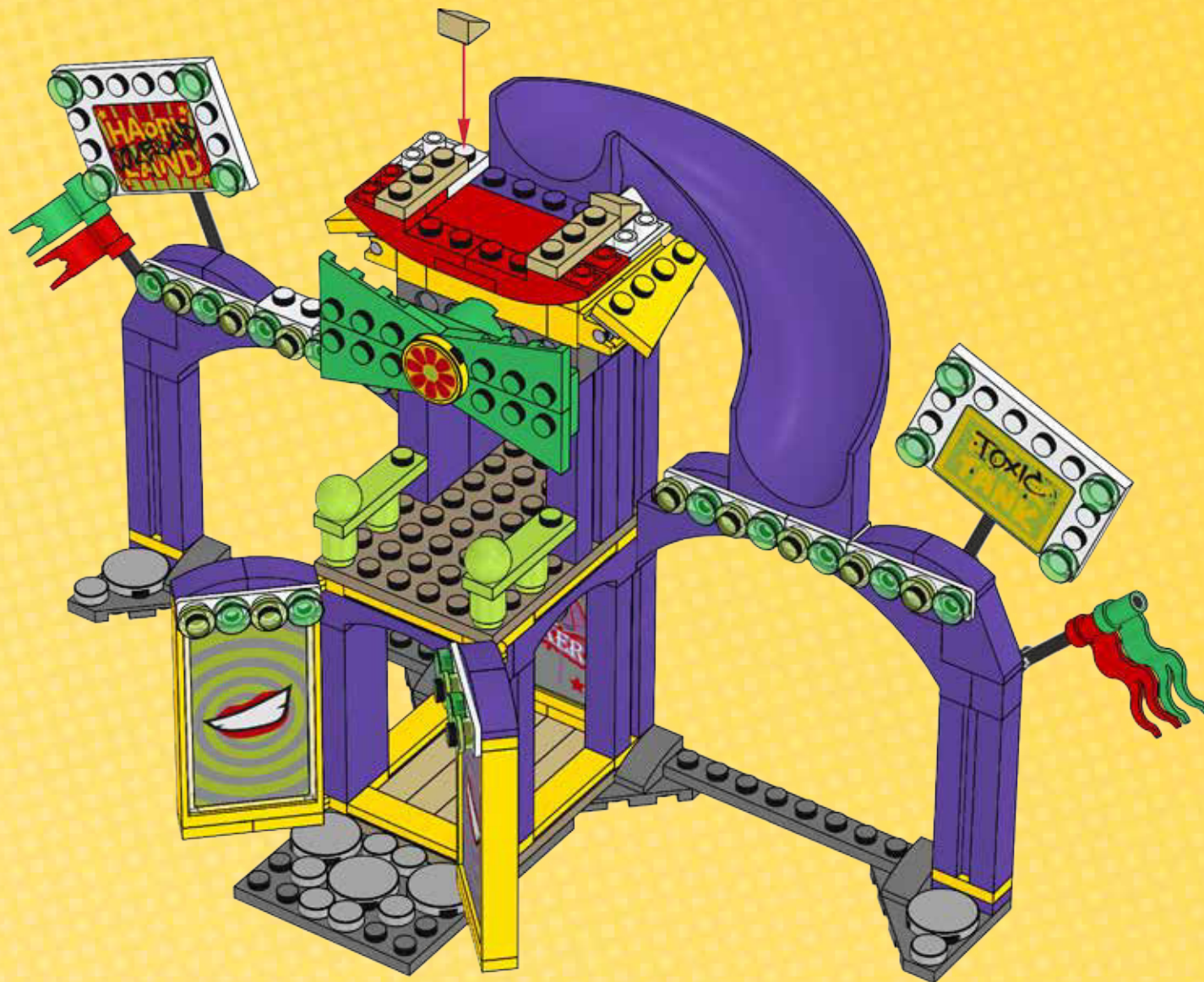



2x



2x

# 49





6x

# 50





2x

# 51



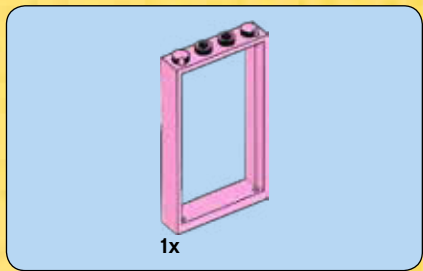

52



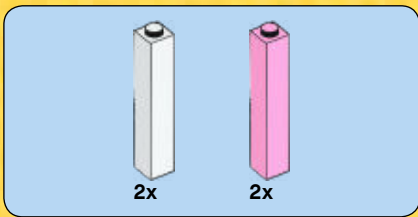

53



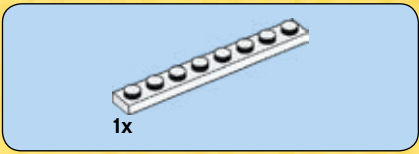

54







2x

# 55



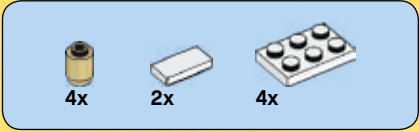

56

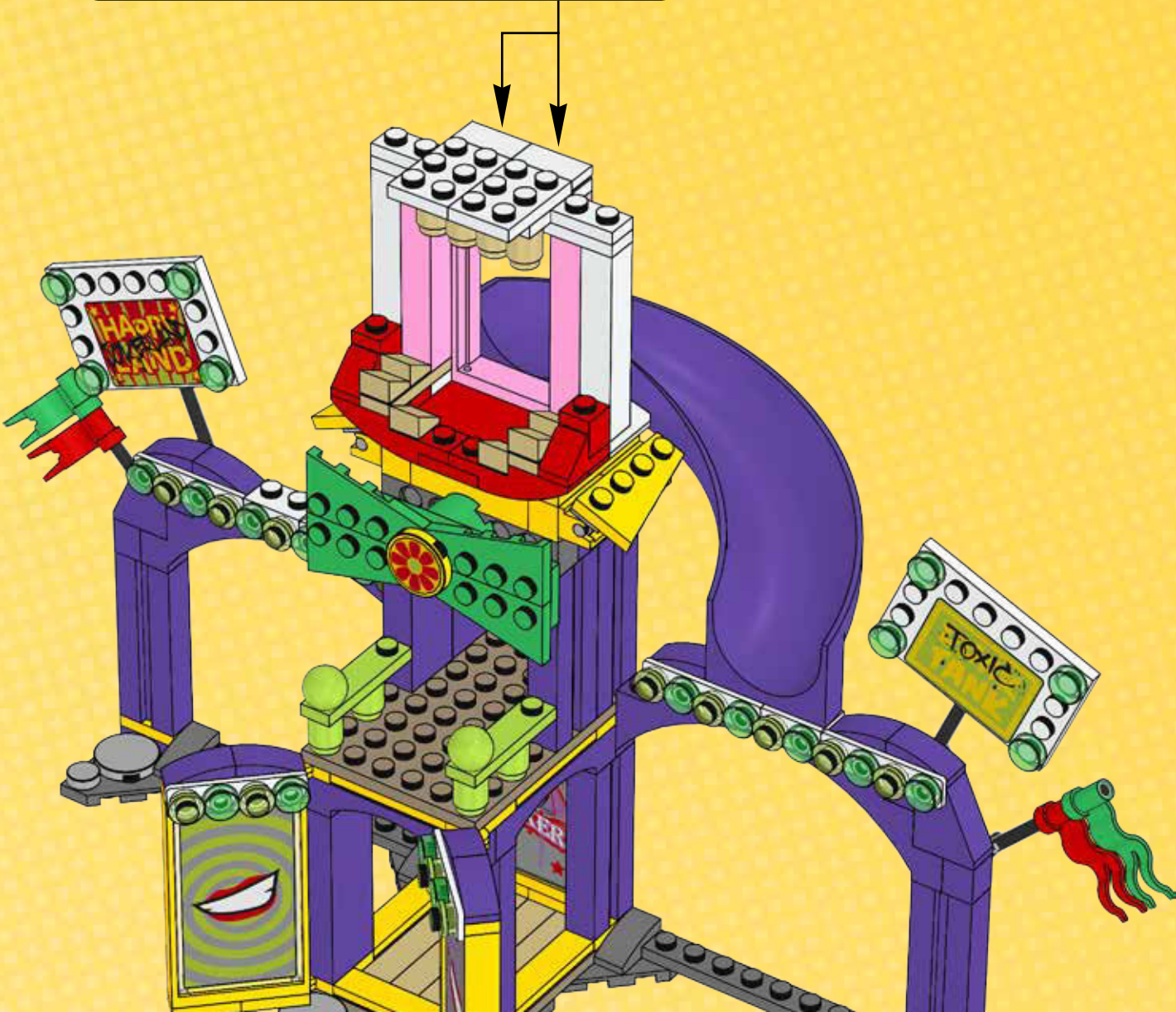
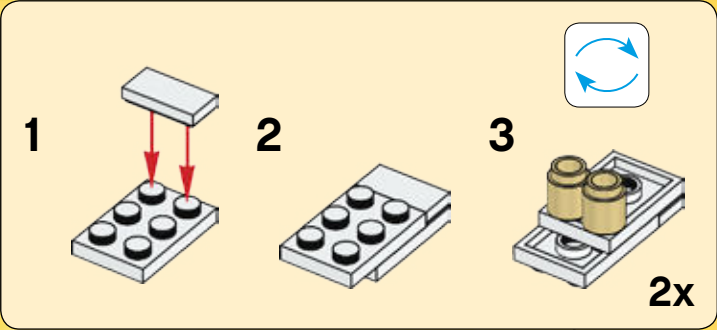



2x

# 57





2x

# 58



2x



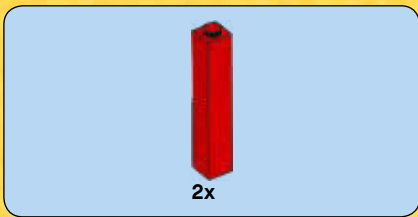

59

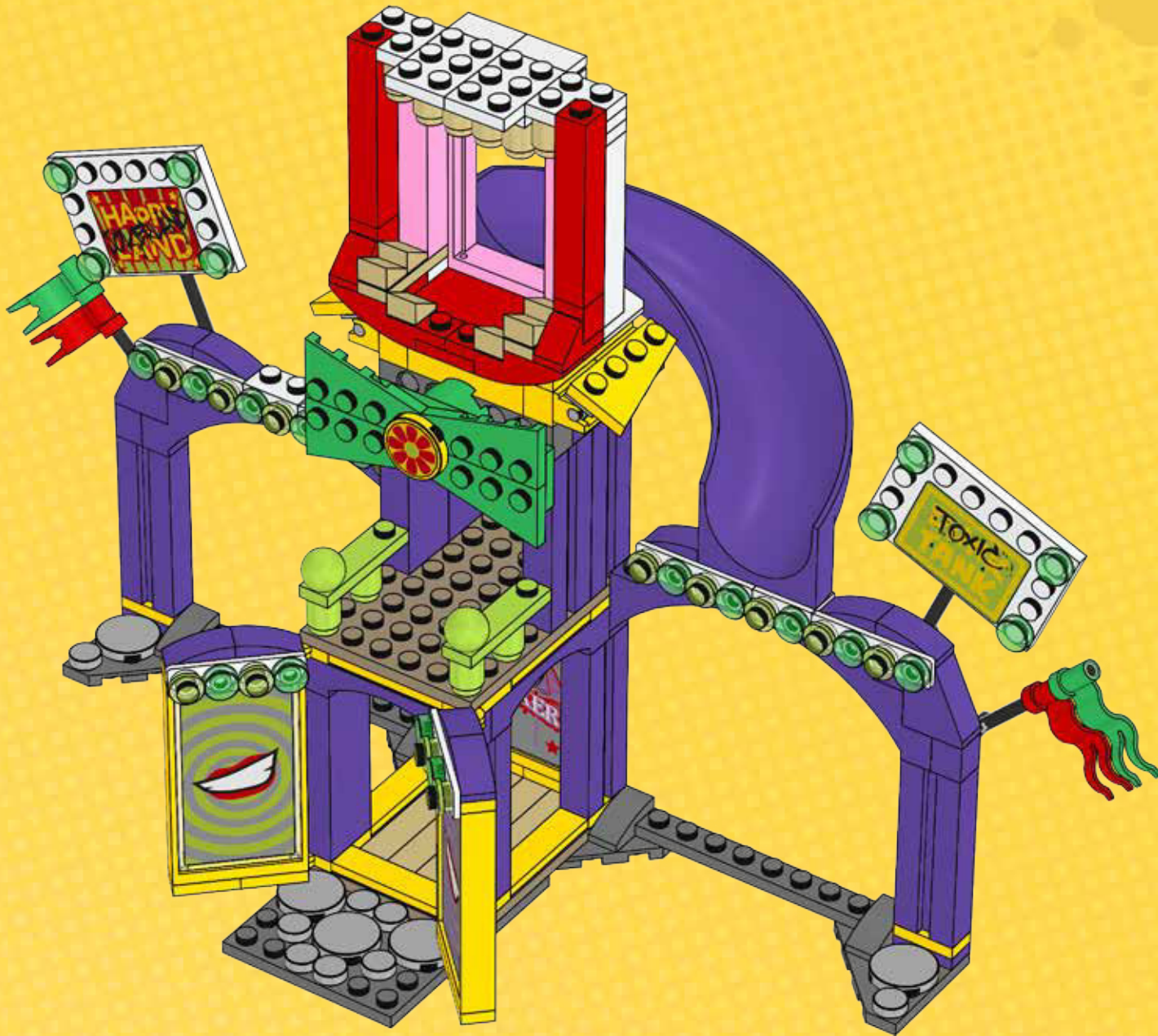

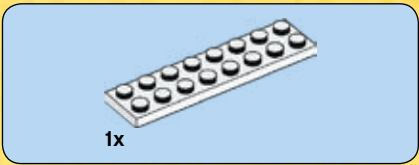

60

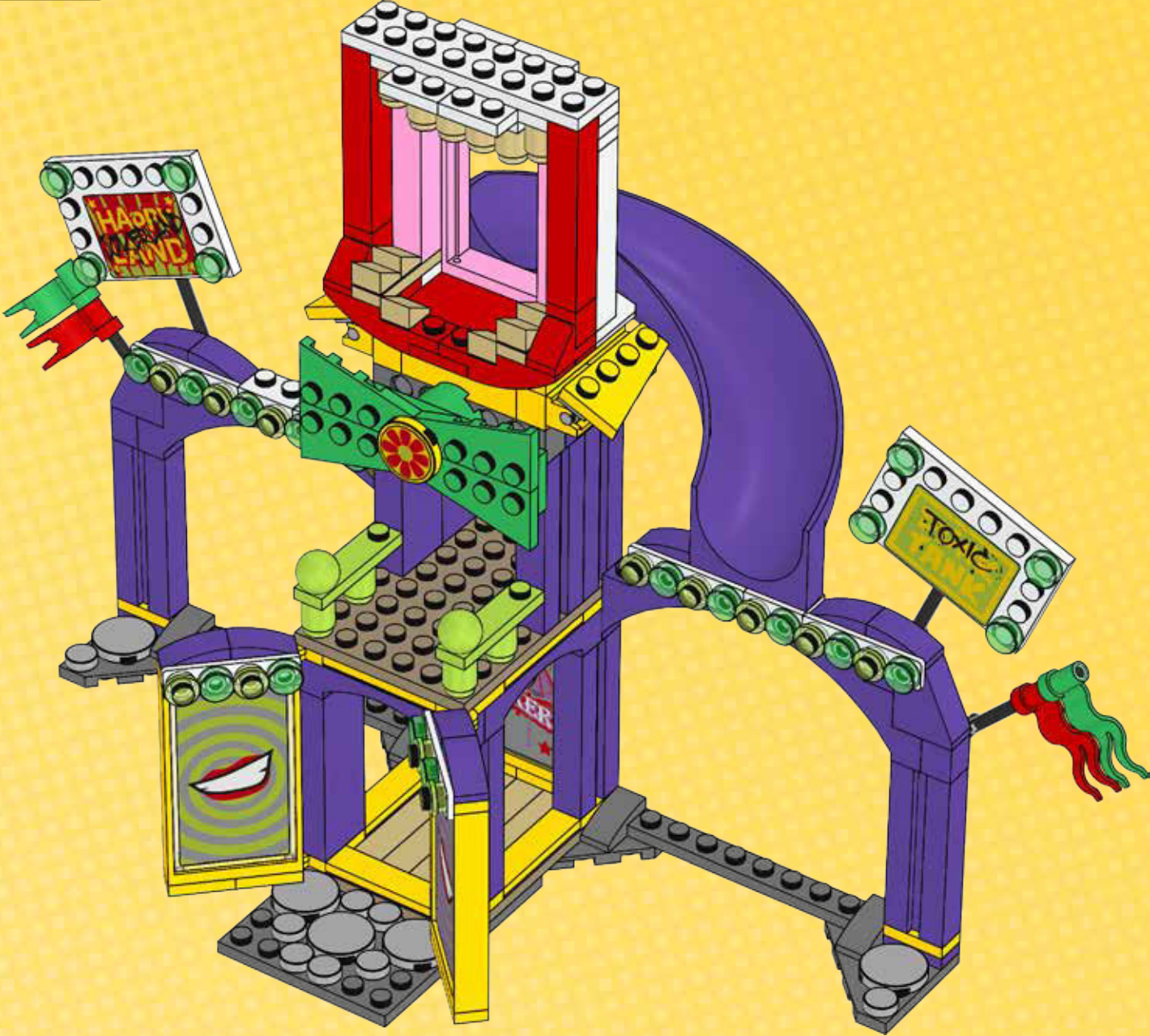

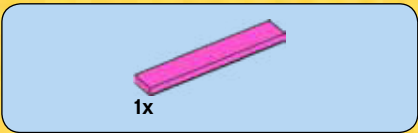

61

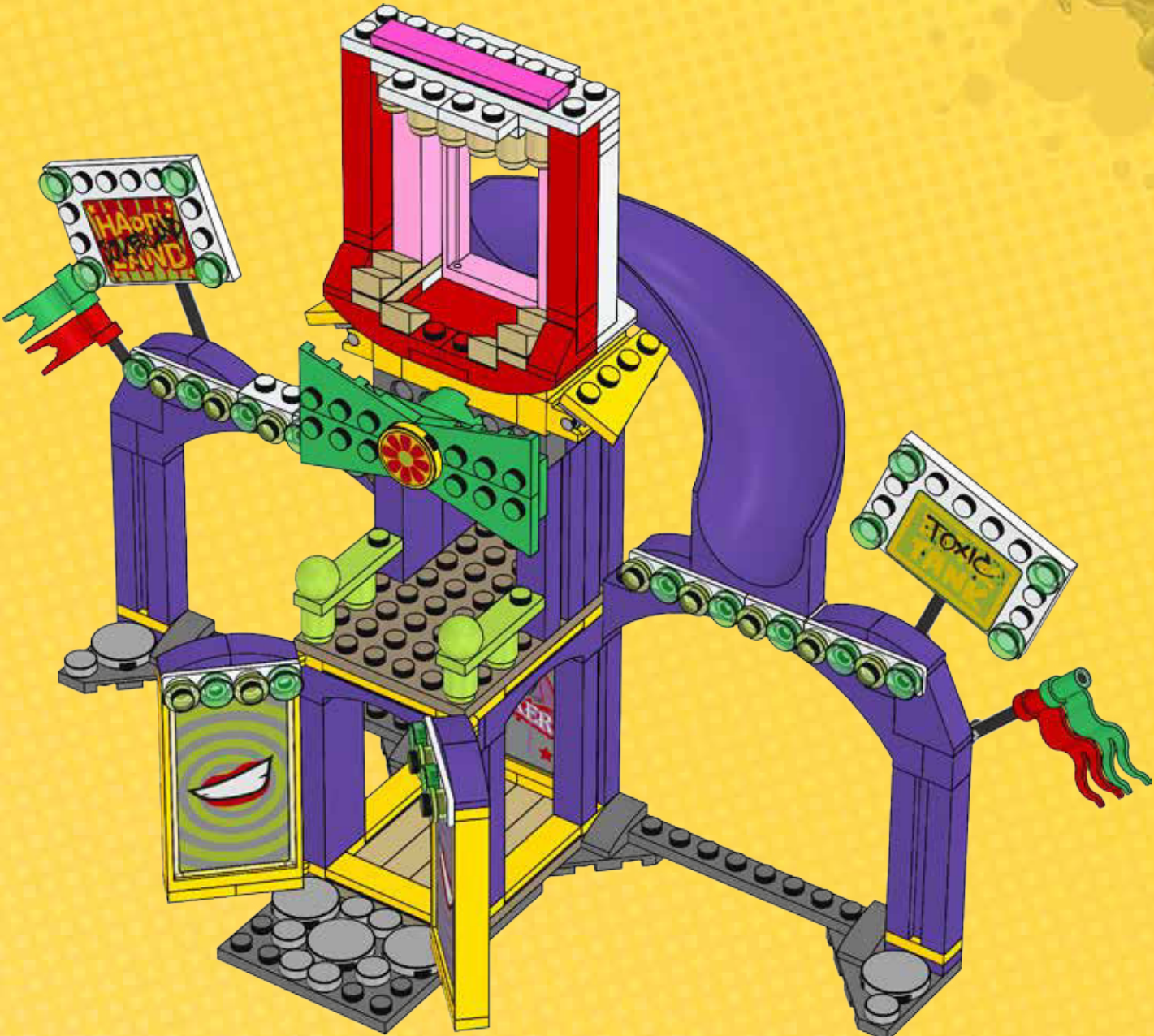



62

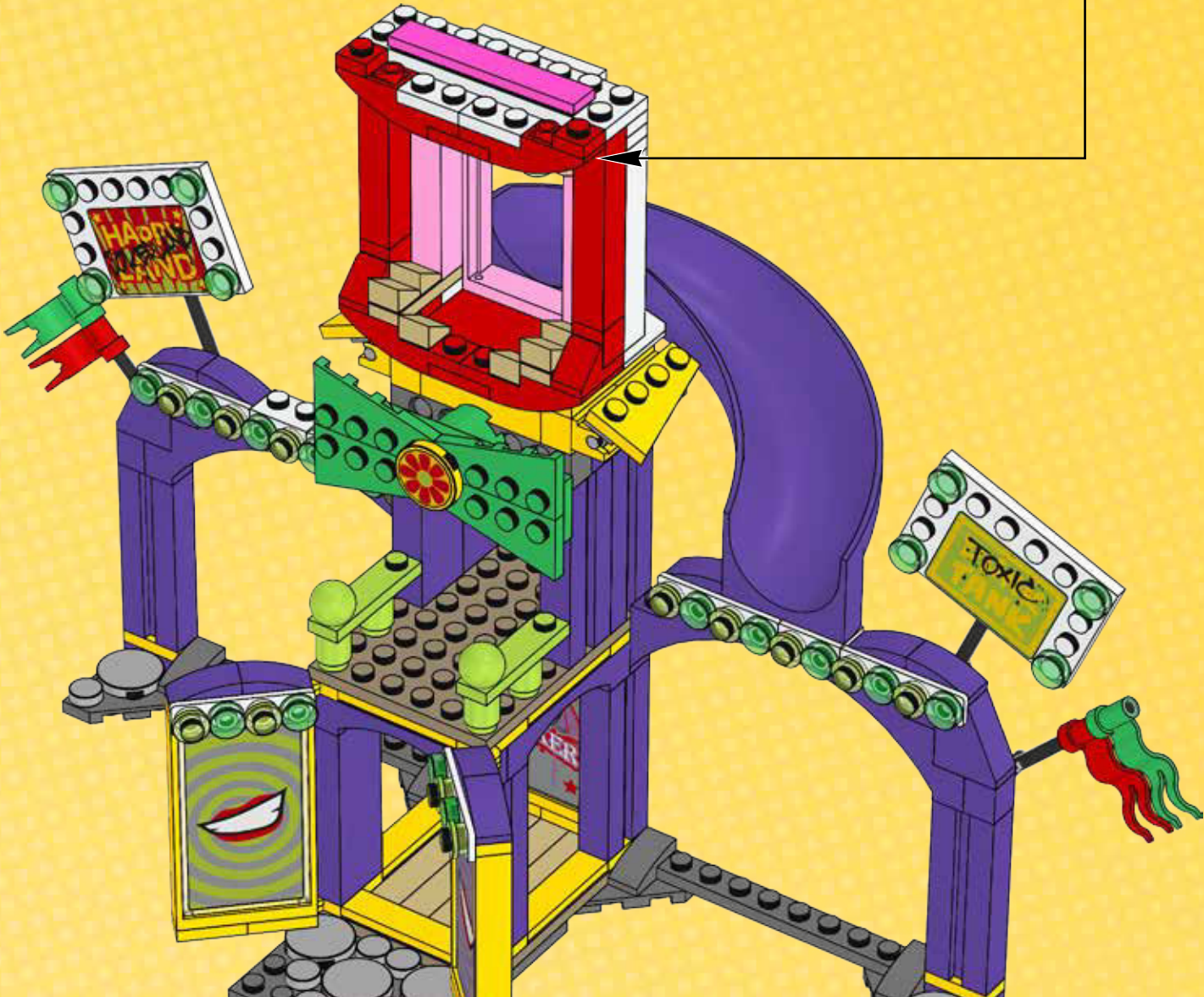
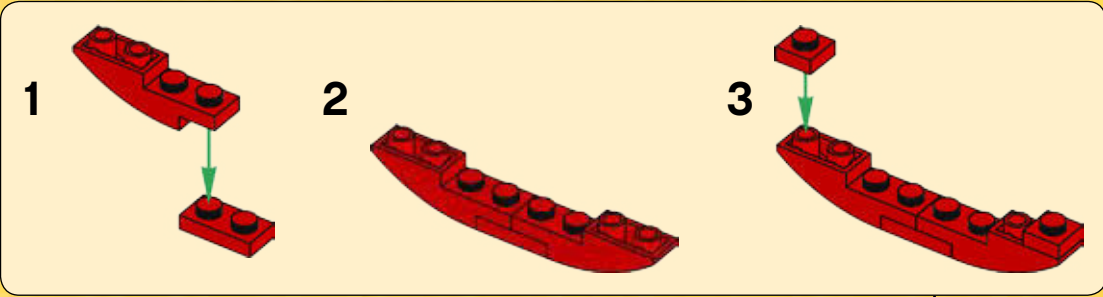



2x

1x

# 63

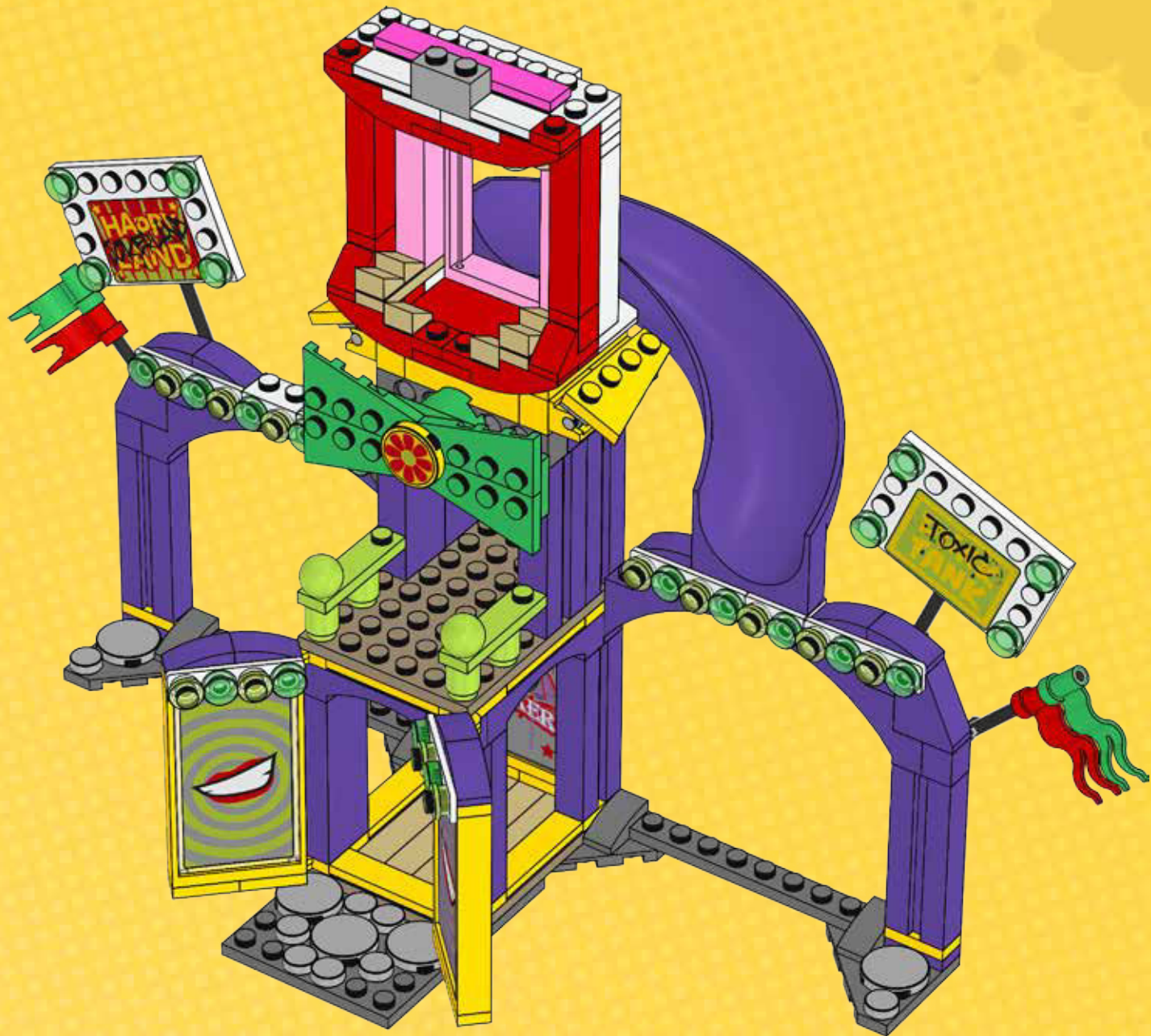

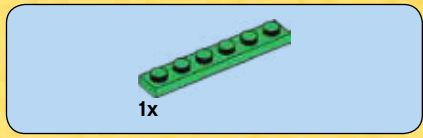

1

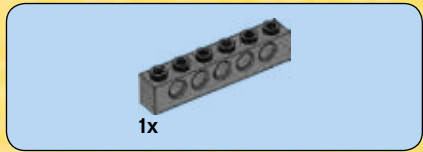
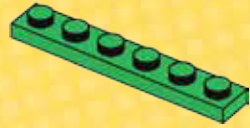

2

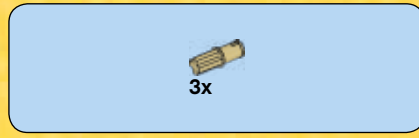
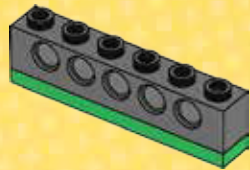

3

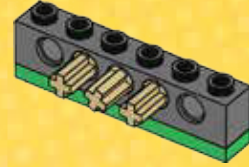

4

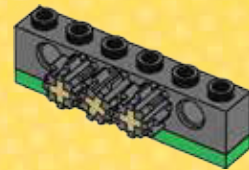

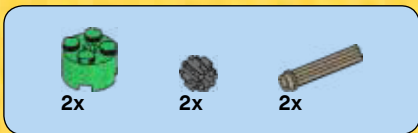

5

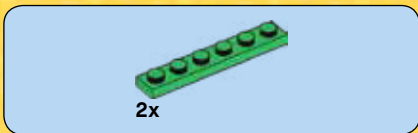
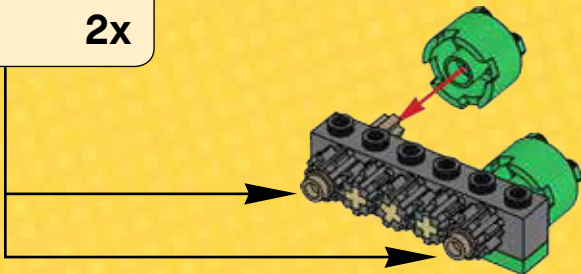
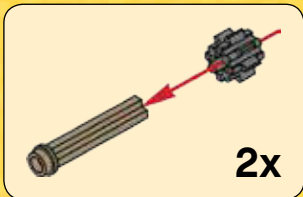

6

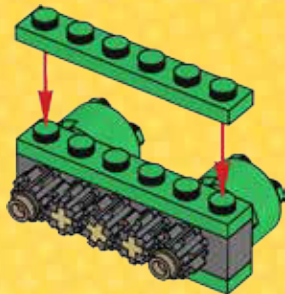

7

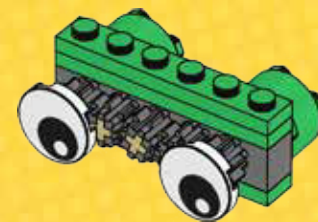

64

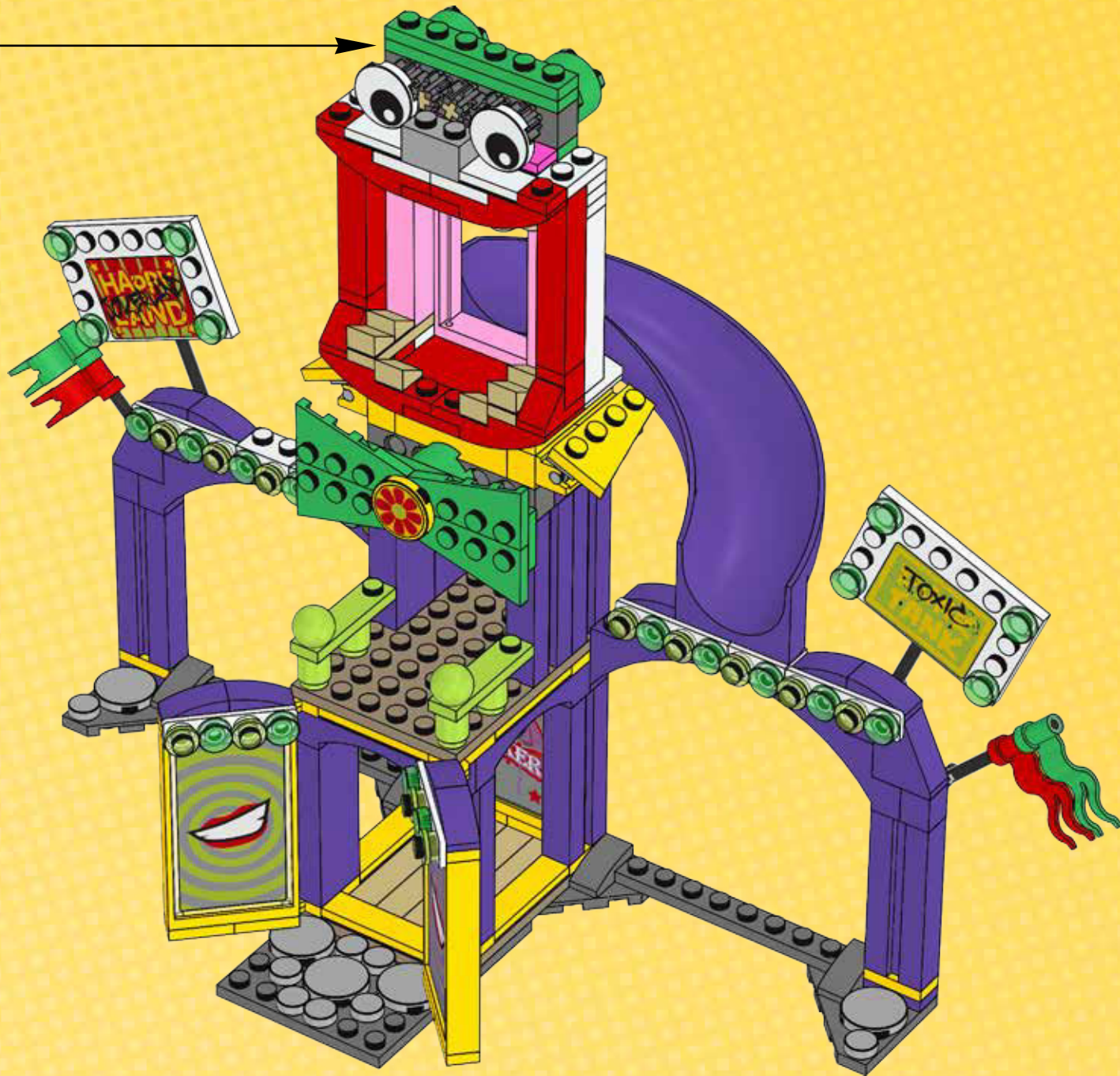



2x

# 65





2x

66

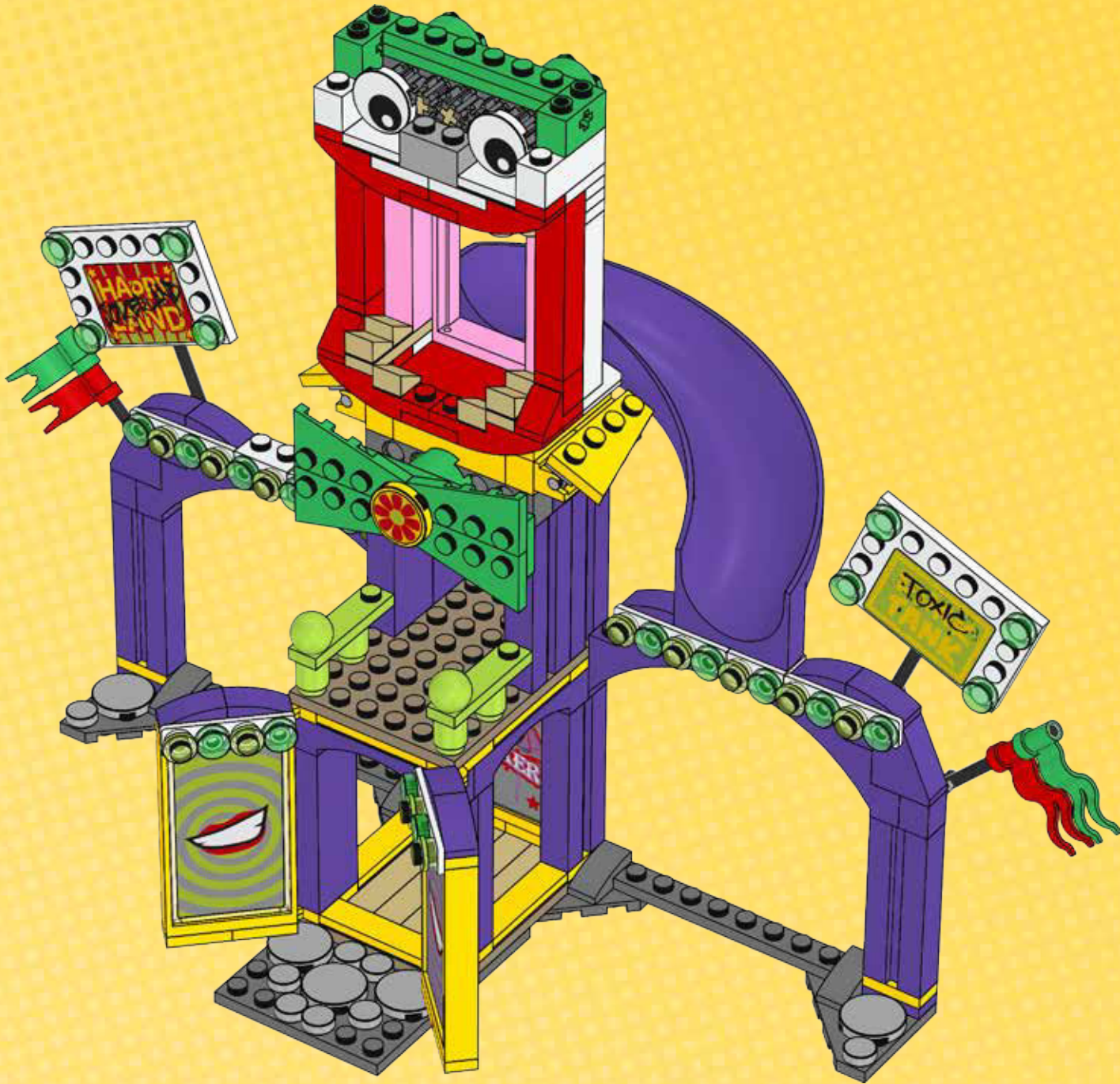

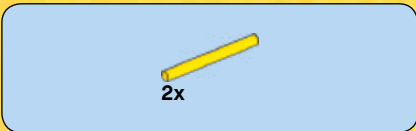

67

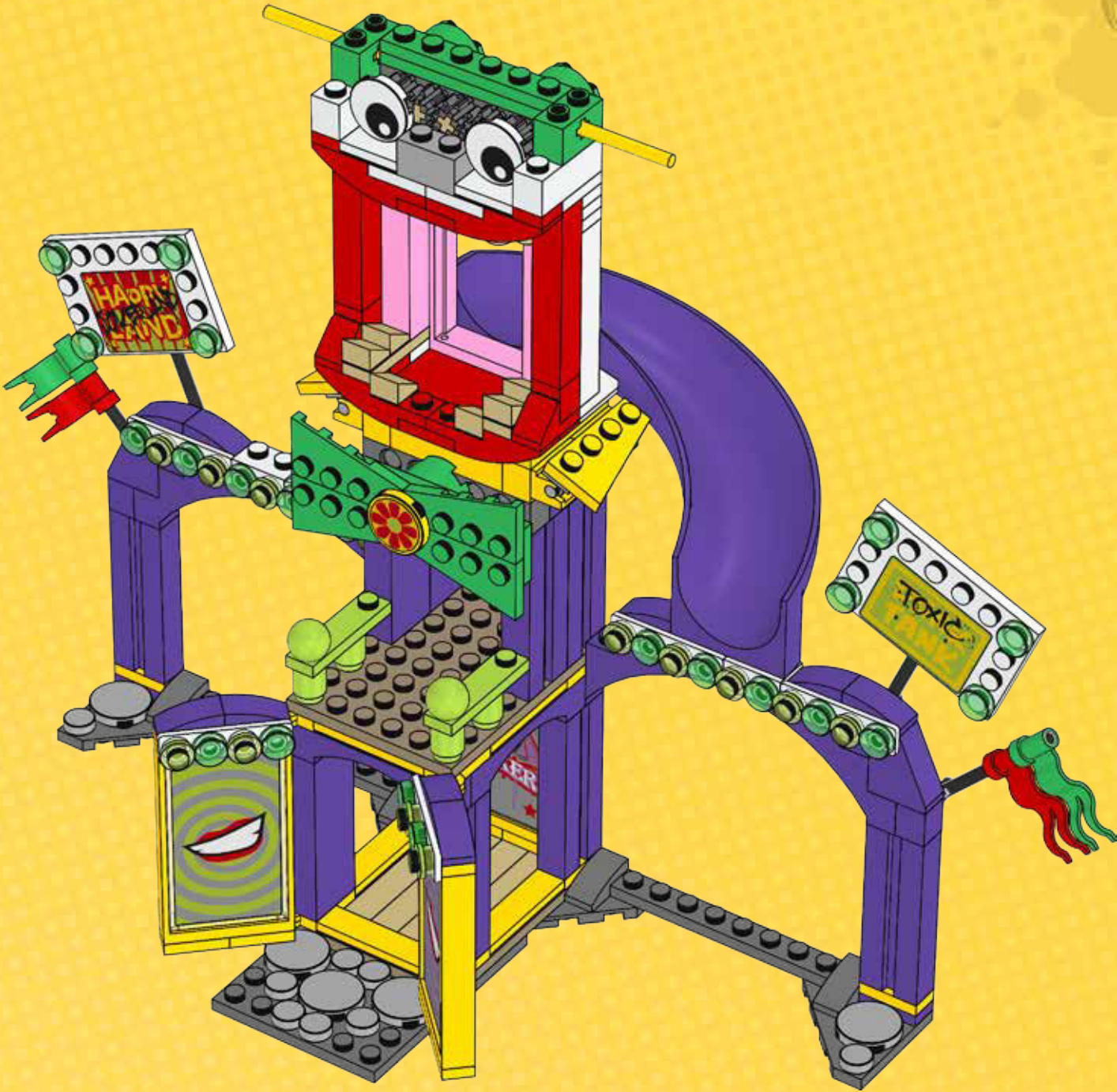



2x



1x

# 68

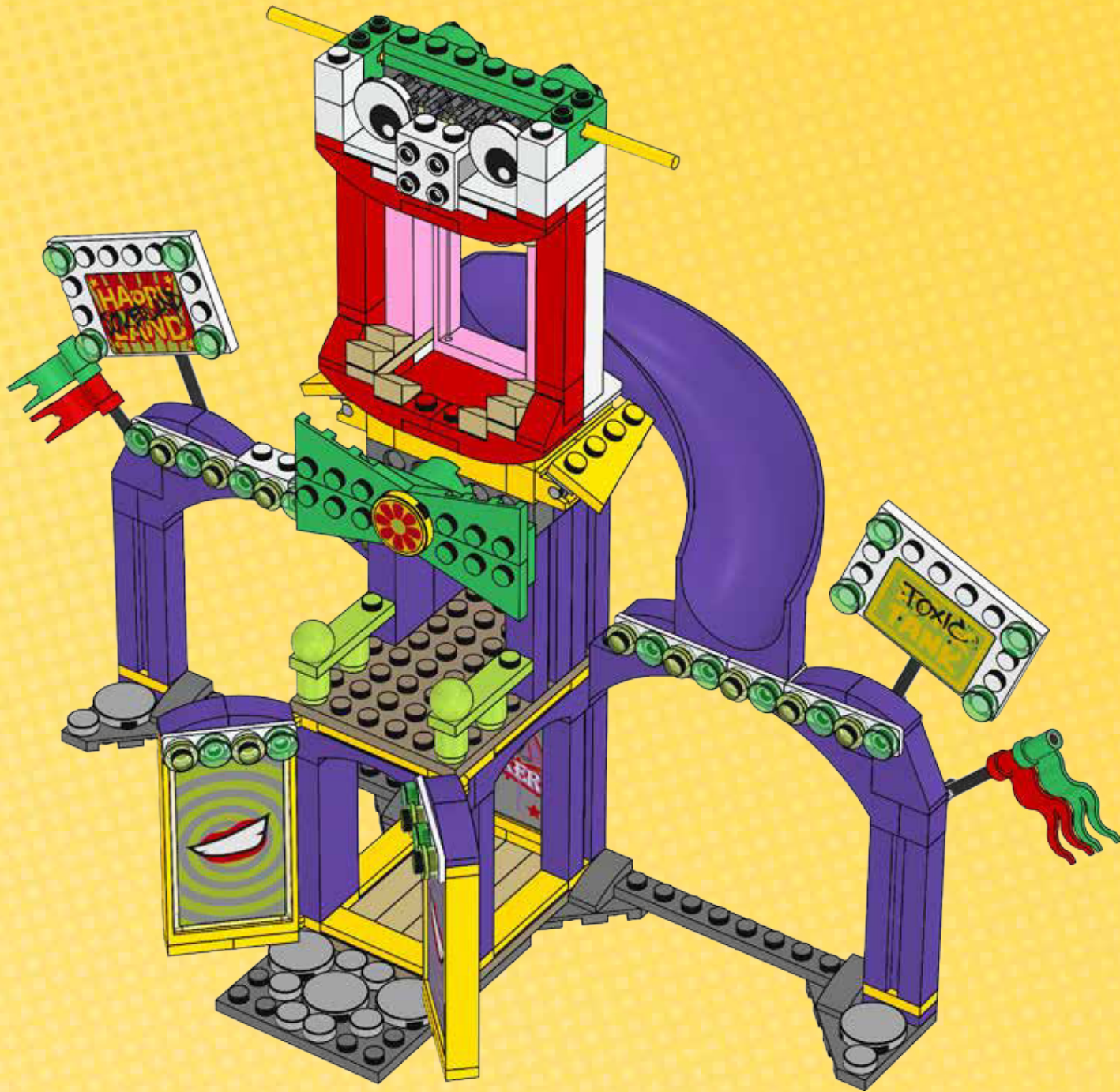





2x



1x

69



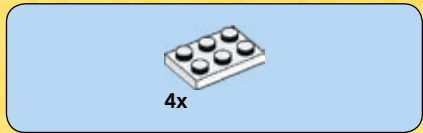

70

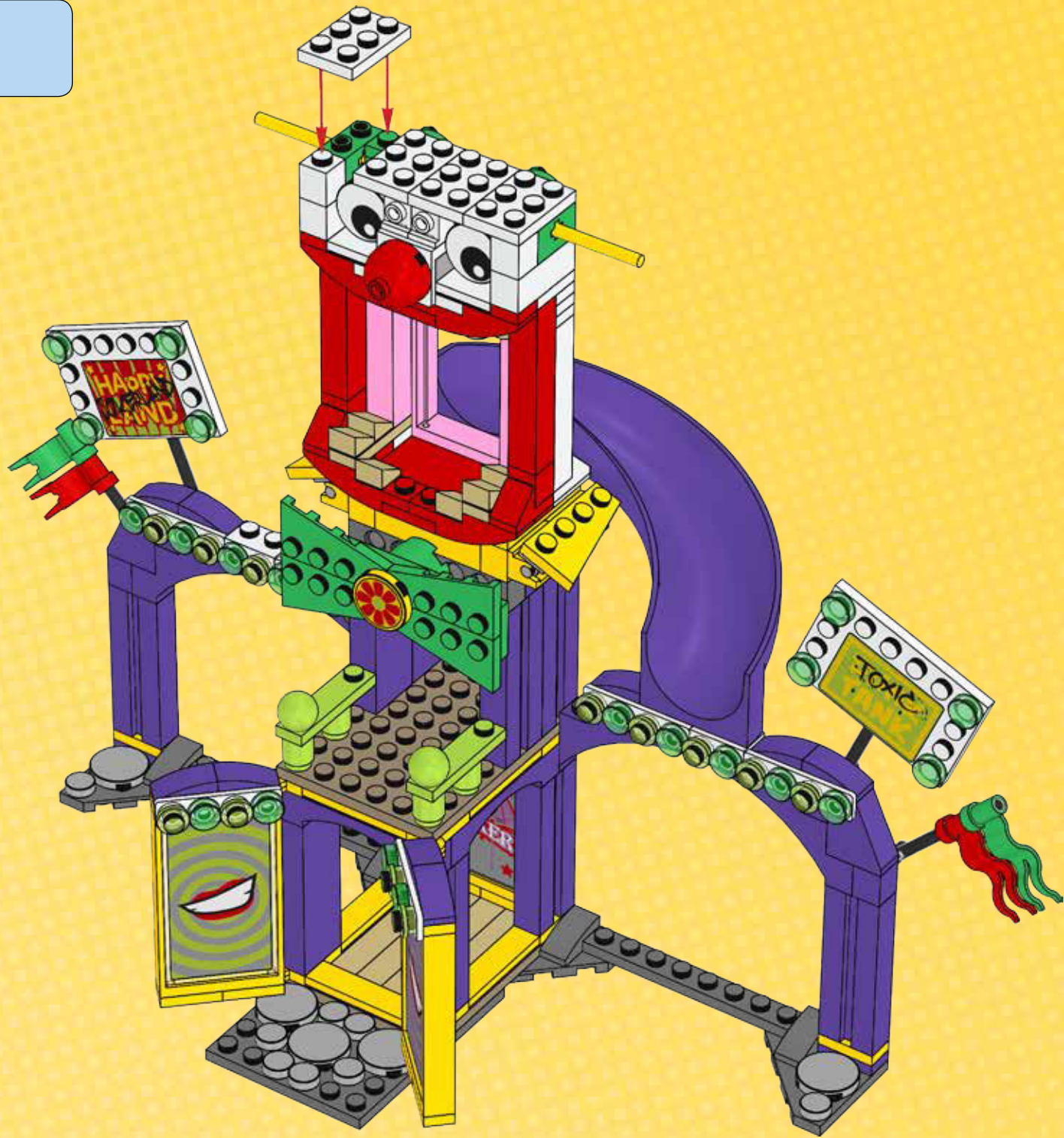



71





72

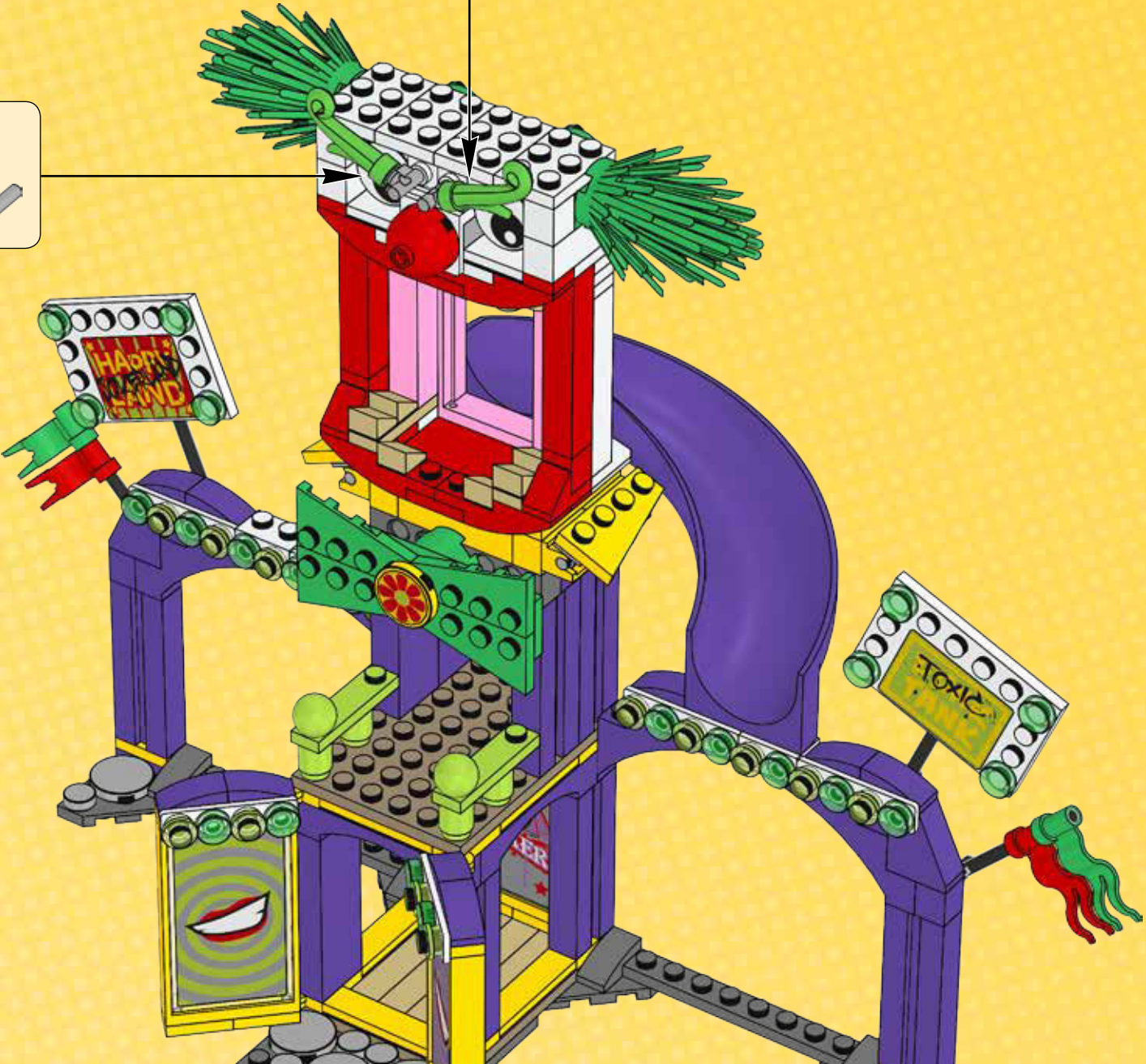
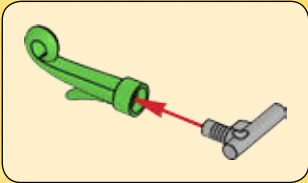
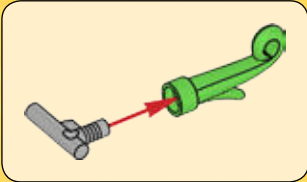

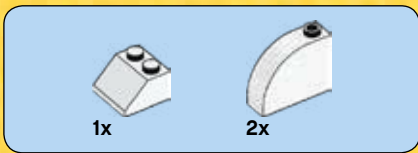

73





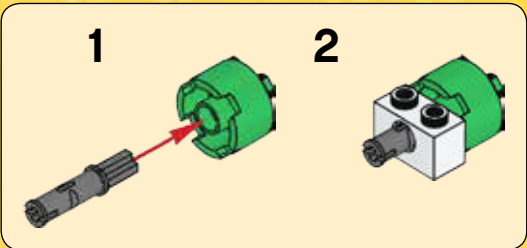

74

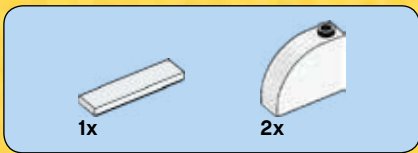





75

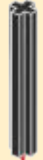

1x  4  1x

 4 **1:1**

4  

# 76

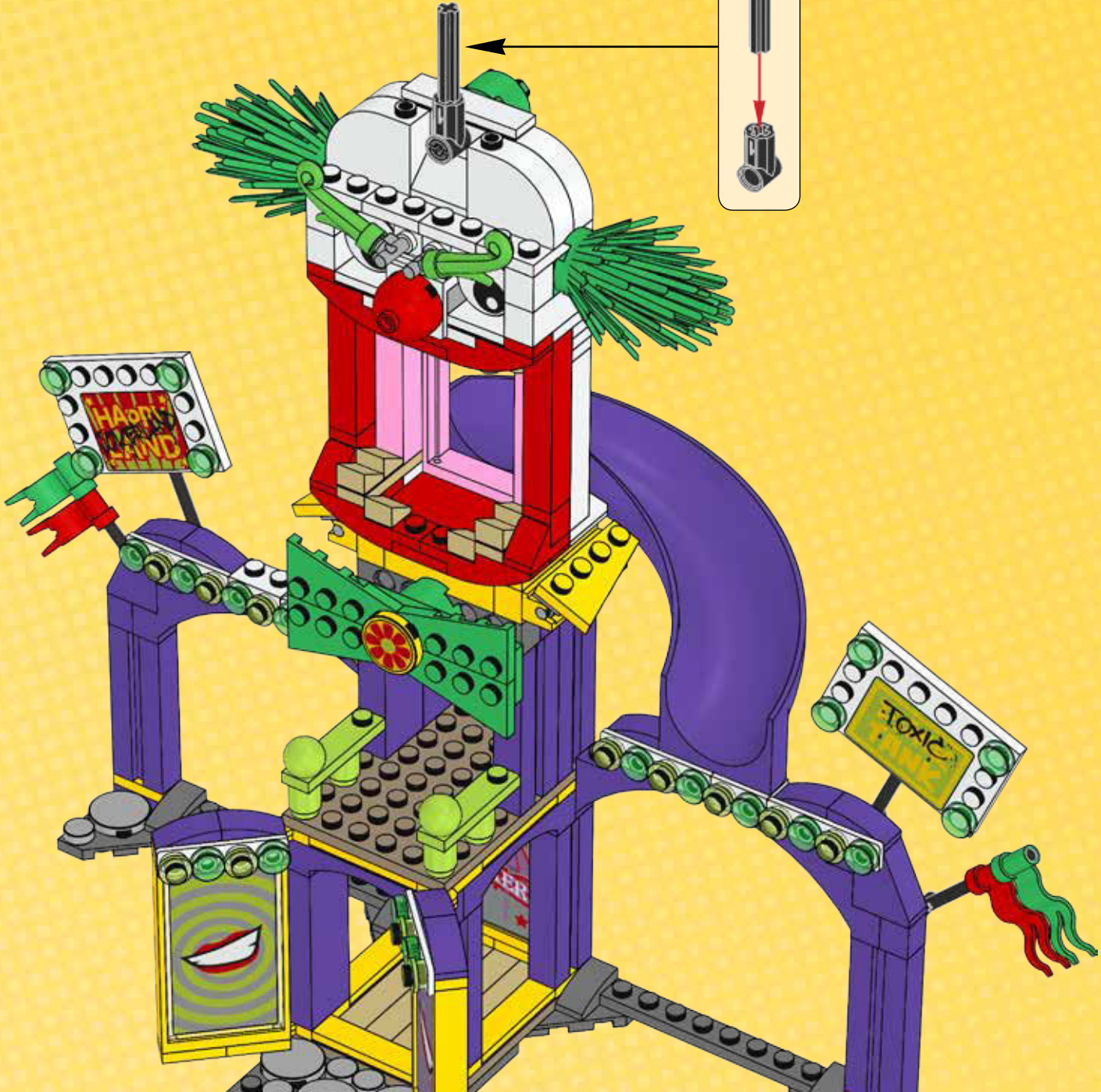



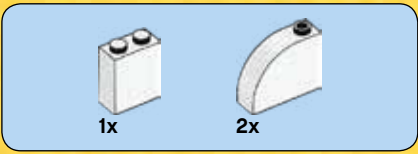

77

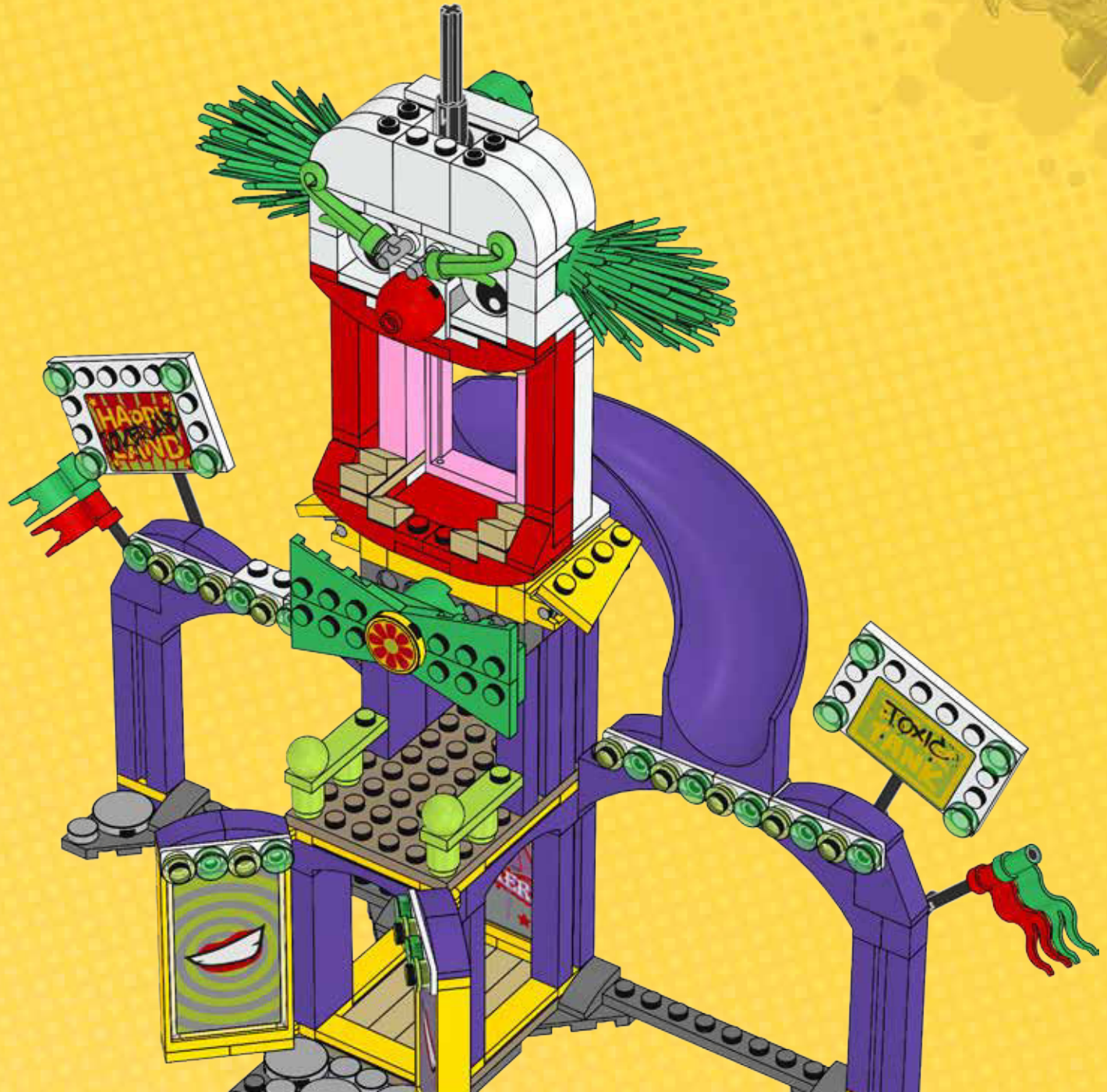

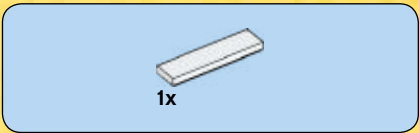

78





79





80



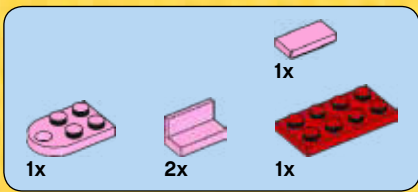

# 81

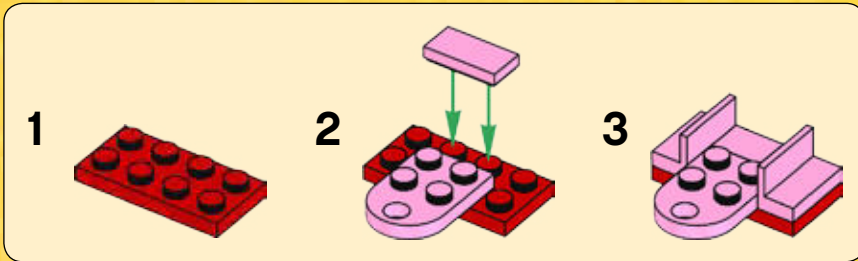

82



83





# SUPER JUMPER





6x 4504369  
2x 245301  
2x 300501  
1x 4113261  
2x 362201  
2x 300101  
2x 407001  
1x 4111971  
1x 370001  
4x 6069002  
2x 446001  
1x 303901  
2x 366001

6x 4141668  
1x 307001  
2x 302301  
4x 306901  
2x 242001  
8x 302101  
2x 243101  
1x 346001  
5x 4163986  
1x 303401  
1x 6117940  
2x 6018774  
6x 6089574  
1x 4160857

1x 4161326  
2x 6060734  
2x 241901  
1x 4652373  
1x 6120936  
1x 6117018  
2x 6117017  
1x 4542616  
4x 6046384  
4x 4526981  
1x 4159739  
10x 4117070

8x 4516055  
8x 6092587  
3x 4113917  
4x 4121921  
4x 4118790  
4x 4157277  
2x 6066344  
4x 4666579  
1x 6120989  
2x 300521  
2x 4212410  
1x 300421  
1x 4216657  
10x 4567445  
1x 4610843  
2x 654121

4x 370121  
4x 4504379  
2x 6053011  
2x 366521  
4x 6057432  
2x 302421  
1x 302321  
2x 306921  
8x 306821  
6x 4533742  
1x 4560179  
2x 302021  
4x 447721  
2x 4632572  
1x 4611701  
2x 4556153  
1x 6061711

1x 4515348  
1x 74335  
2x 449521  
1x 6121092  
1x 6120919  
1x 6120892  
1x 4661509  
1x 6019664  
4x 4538780  
2x 6048859  
1x 4290714  
2x 4107824  
1x 4227155  
5x 4142865  
2x 300923  
4x 4119014  
2x 4121936

2x 6055065  
2x 4206330  
2x 4587840  
1x 4199519  
2x 4613257  
2x 4143005  
5x 4206482  
2x 4514553  
6x 4569076  
6x 300424  
4x 301024  
2x 4164073  
1x 370124  
2x 4504381  
3x 4550348  
3x 303924  
4x 6102768

- 2x 4656699
- 3x 6064071
- 17x 302324
- 6x 243124
- 1x 379524
- 1x 303224
- 2x 4540040
- 3x 4188313
- 4x 614124
- 1x 4161331
- 1x 4160868
- 1x 6078279
- 3x 4260192
- 3x 4561507
- 226
- 2x 6116606
- 1x 6112399
- 4x 4490142
- 4x 393724
- 1x 6116995
- 2x 300426
- 4x 407026
- 1x 473326
- 1x 6024730
- 4x 6116990
- 10x 4548180
- 2x 6069000
- 2x 4121966
- 2x 303926
- 10x 4504382
- 2x 4570397
- 2x 4570401
- 12x 6047276
- 1x 6116994
- 4x 4613153
- 1x 365926
- 2x 307026
- 2x 302426
- 8x 302326
- 8x 306826
- 9x 302226
- 3x 302126
- 5x 243126
- 1x 4560182
- 2x 6076678
- 1x 346026
- 1x 303426
- 3x 4514845
- 1x 6066102
- 1x 4144023
- 2x 6020193
- 4x 4258354
- 4x 6061032
- 3x 281726
- 1x 3200126
- 2x 403226
- 1x 4278359
- 1x 4180087
- 2x 6116604
- 1x 395726
- 4x 4623113
- 1x 6081988
- 1x 6029944
- 1x 6103100
- 1x 6079896
- 1x 6103326
- 1x 4105175
- 3x 4223247
- 1x 4650620
- 1x 6097079
- 2x 4649700
- 4x 4550937
- 2x 6064174
- 1x 4530673
- 1x 4656764
- 3x 3003126
- 2x 6052851
- 1x 4191191
- 4x 4547625
- 1x 4273590
- 2x 4143372
- 2x 6102734
- 3x 6088489
- 1x 4495935
- 3x 4290713
- 1x 4142236
- 1x 4162857
- 1x 4107783
- 4x 4107085
- 2x 4184169
- 15x 4121715
- 2x 4107081
- 1x 4512363
- 4x 4140801
- 5x 370526
- 3x 370626
- 6x 4251378
- 2x 4233489
- 2x 6021539
- 1x 4558593
- 2x 302428
- 3x 302328
- 4x 4157120
- 3x 366628
- 1x 303428

4

6

7

3x  
4542391



3x  
6117024



2x  
4543259



2x  
4543262



3x  
403228



1x  
6055462



2x  
606428



2x  
449528



1x  
74040



1x  
6120878



1x  
4655389



1x  
4583684

1x  
4249063



2x  
6050929



2x  
6117031



1x  
6097392



2x  
4624987



4x  
4569297



1x  
6018931



3x  
4639698



4x  
4599452



1x  
6093683



10x  
4646864



2x  
6033019

6x  
4650500



3x  
3006347



26x  
4646860



5x  
3005749



2x  
3006349



3x  
4159007



1x  
6055326



1x  
4654448



1x  
4124083



4x  
4212454



4x  
4500125



2x  
6058127



4x  
4504705

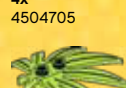

2x  
6023832



1x  
4655379

1x  
4659708



4x  
4655210



2x  
6061678



2x  
6117028



2x  
4624381



1x  
6120856



1x  
4507045



1x  
4267874



4x  
6015424



1x  
6120877



2x  
4541618



2x  
6031821



1x  
4251796

4x  
4625236



6x  
4646865



3x  
4261397



1x  
6116987



4x  
6097037



1x  
4282860



2x  
4211666



1x  
6034334



1x  
6116613



1x  
4538252



1x  
4211388



1x  
6090091



1x  
4211640



1x  
4211640

1x  
4211365



8x  
4650260



2x  
4211614



2x  
4211494



2x  
6075066



3x  
6063898



4x  
4211350



2x  
4211397



4x  
4211429



8x  
4211445



2x  
4211438



3x  
4541978



3x  
4654580



2x  
4211632



2x  
4535738

2x  
4211443

4x  
6019212



5x  
6052200



6x  
4278273



1x  
4507056



2x  
4514195



3x  
4641048



2x  
4590443



4x  
4211470



1x  
4211862



2x  
4211573



1x  
4278756



10x  
4211807



1x  
4211815



1x  
4211508





2x  
4211088

- 1x 4211796
- 2x 4211103
- 1x 4210700
- 4x 6099909
- 1x 4211111
- 2x 4210917
- 2x 4567887
- 4x 6029948
- 1x 4211065
- 2x 4210726
- 4x 6117972
- 6x 4543086
- 2x 4210660
- 3x 6013082
- 2x 4521187
- 1x 4260707
- 2x 4211042
- 4x 4210728
- 3x 4626645
- 1x 6103106
- 1x 6100030
- 1x 6015356
- 1x 4210665
- 1x 6083620
- 1x 4508553
- 2x 6020189
- 1x 4211097
- 5x 6012451
- 4x 4257526
- 2x 4210678
- 1x 4210794
- 3x 4211114
- 1x 4649764
- 2x 6058396
- 8x 4540386
- 2x 4289542
- 2x 6051334
- 2x 4211029
- 1x 4502068
- 1x 6120935
- 2x 6048898
- 1x 4648252
- 2x 6117039
- 1x 4580010
- 1x 6117045
- 2x 4619591
- 1x 6119404
- 2x 6104154
- 4x 6063897
- 10x 6117037
- 2x 6022070
- 11x 6057390
- 4x 6117040
- 2x 4655695
- 1x 6117046
- 1x 4586410
- 1x 6120881
- 1x 6121010
- 1x 6120889
- 1x 6056286
- 1x 6121011
- 2x 4566522
- 1x 4652300
- 1x 4659709
- 1x 6029935
- 1x 6005755
- 14x 6057034
- 2x 6057005
- 3x 4571137
- 1x 6019608
- 1x 6038196
- 2x 4617190
- 1x 6029933
- 2x 4194535
- 4x 4222960
- 1x 4655256
- 4x 6056271
- 2x 6097036



**Customer Service**  
**Kundenservice**  
**Service Consommateurs**  
**Servicio Al Consumidor**  
**LEGO.com/service or dial**

00800 5346 5555 :   
 1-800-422-5346 : 

**LEGO**

DC COMICS  
**SUPER  
HEROES**



**76034**



**SUPER  
JUMPER**

**2**

**1**



**76035**



BATMAN and all related characters and elements are trademarks of and © DC Comics.

LEGO and the LEGO logo are trademarks of the LEGO Group.  
©2015 The LEGO Group.

WB SHIELD: TM & © Warner Bros. Entertainment Inc.  
(s15)



# club™



1



2



3



**LEGO**

# BATMAN 3

## BEYOND GOTHAM



**7**<sup>TM</sup>  
www.pegi.info

PROVISIONAL

Check the Classification

# AVAILABLE NOW

PS4

PS3

PSVITA

XBOX ONE

XBOX 360



games



LEGO Video Games

PC

Wii U

NINTENDO 3DS

Nintendo eShop

© 2014 The LEGO Group.™ & DC Comics.™ & © WBEI. (s14)

# WIN

GO TO [WWW.LEGO.COM/PRODUCTFEEDBACK](http://WWW.LEGO.COM/PRODUCTFEEDBACK) AND GIVE US YOUR SHORT **FEEDBACK** ABOUT THIS LEGO® SET FOR A CHANCE TO WIN A COOL LEGO PRIZE.



## LEGO.com/productfeedback

### GEWINNE



Erzähle uns auf [www.LEGO.com/productfeedback](http://www.LEGO.com/productfeedback)

etwas über die Erfahrungen, die du mit diesem LEGO® Set gemacht hast, und sichere dir die Chance auf einen coolen LEGO Preis!

### GAGNE



Rends-toi sur [www.LEGO.com/productfeedback](http://www.LEGO.com/productfeedback)

et donne-nous quelques commentaires sur ce produit LEGO® pour avoir une chance de gagner un prix LEGO !

### GANAN



Visita [www.LEGO.com/productfeedback](http://www.LEGO.com/productfeedback)

y envíanos tu opinión acerca de este set LEGO®. ¡Participarás en el sorteo de un premio LEGO!

### 获取奖品



登录 [www.LEGO.com/productfeedback](http://www.LEGO.com/productfeedback)

给出关于此乐高®套装的简短反馈，就有机会获得炫酷乐高奖品

### 경품 당첨 기회



[www.LEGO.com/productfeedback](http://www.LEGO.com/productfeedback)

페이지로 이동하여 이 레고® 세트에 대한 간략한 피드백을 보내 주시고 멋진 레고 경품을 탈 수 있는 기회도 잡으십시오

### ЗАПОЛНИ АНКЕТУ И ПОЛУЧИ ПРИЗ



Перейди по ссылке [www.LEGO.com/productfeedback](http://www.LEGO.com/productfeedback)

ответь всего на несколько вопросов об этом наборе LEGO®, и у тебя появится шанс выиграть замечательный приз от компании LEGO.