

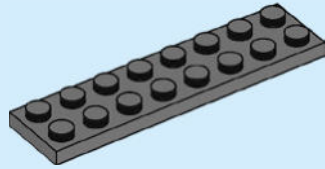

1

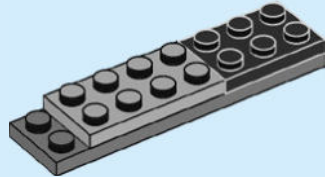

2



3

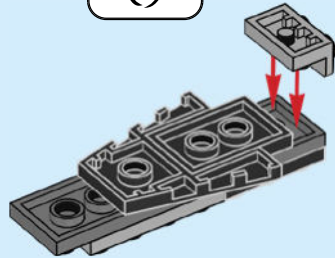

4

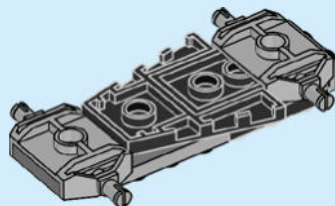

5

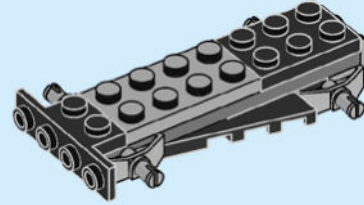

6

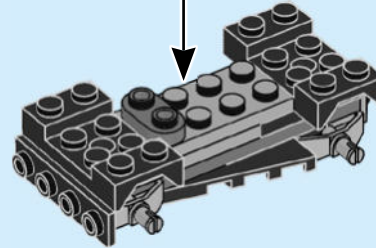
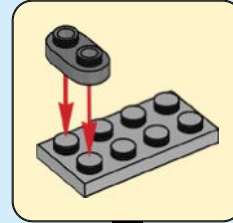

7

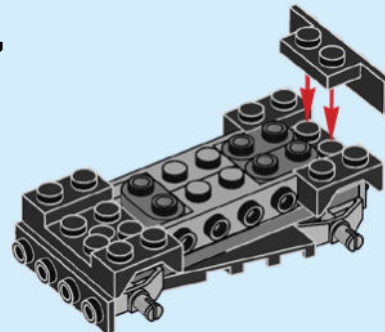

8

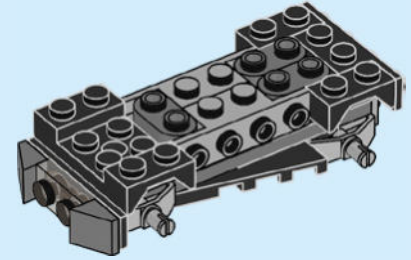

9

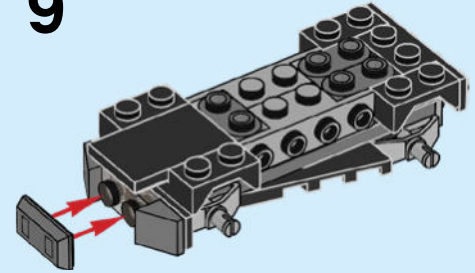

10

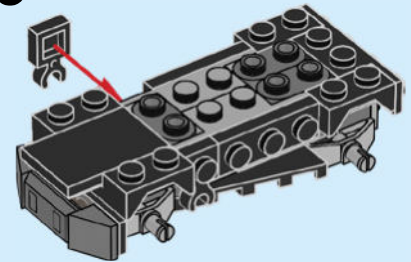

11

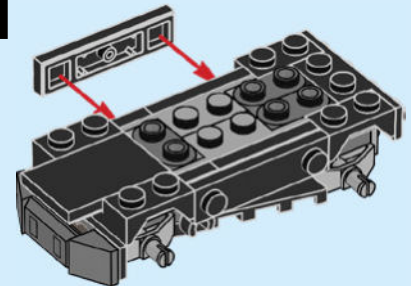

12

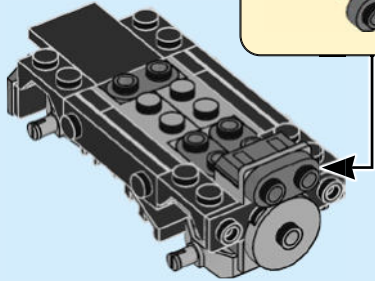
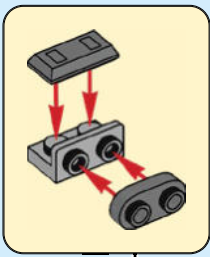

13

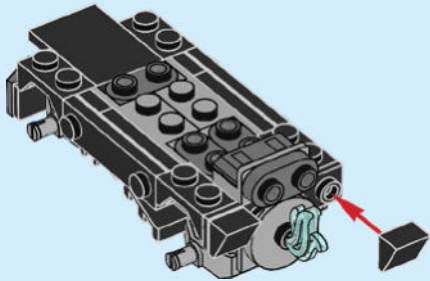

14

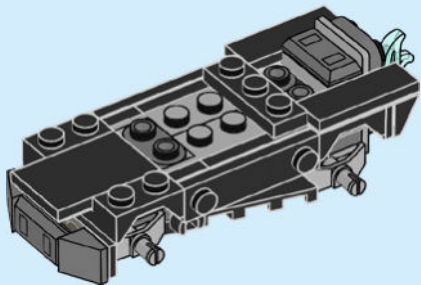

15

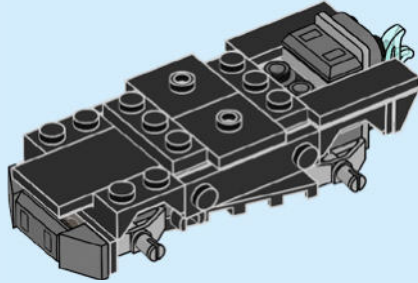

16

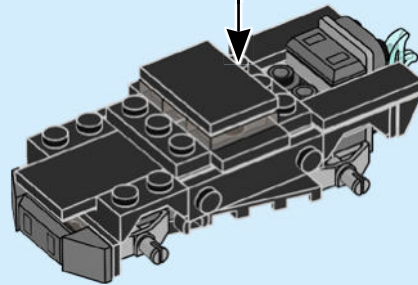
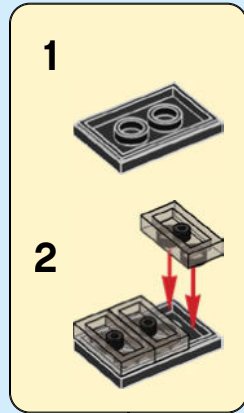

17

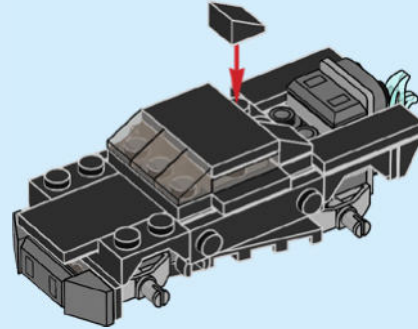

19

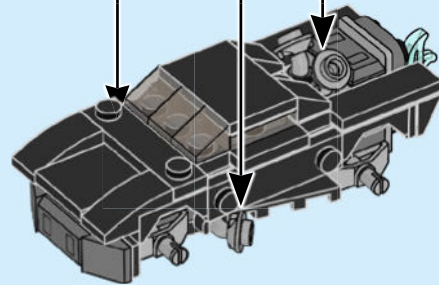
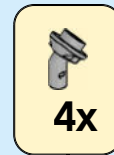

20

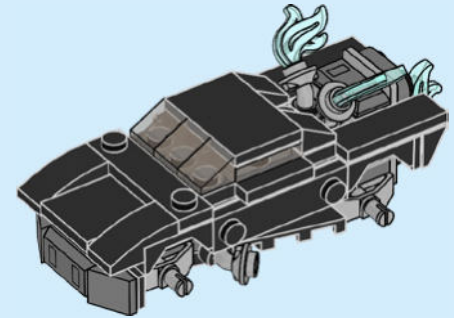

21

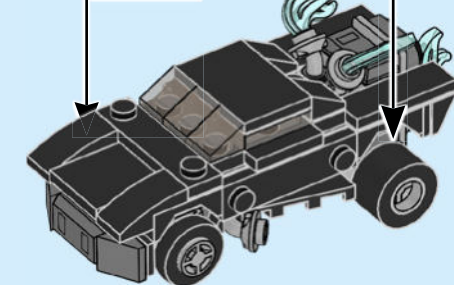
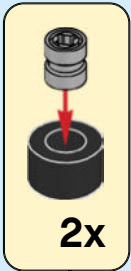
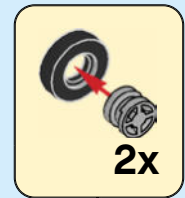

[LEGO.com/DCSUPERHEROES](http://LEGO.com/DCSUPERHEROES)

[LEGO.com/service](http://LEGO.com/service)

LEGO and the LEGO logo are trademarks of the LEGO Group.  
©2022 The LEGO Group. 6380101



THE BATMAN and all related characters and elements © & ™ DC Comics and Warner Bros. Entertainment Inc. WB SHIELD: © & ™ WBEI. (s22)